

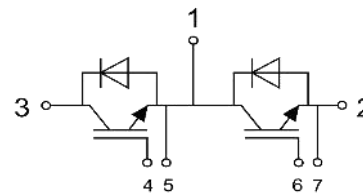
$V_{CES} = 1200V$ $I_C = 75A$ at $T_C = 80^\circ C$ $t_{SC} \geq 10\mu sec$ $V_{CE(ON)} = 1.90V$ at $I_C = 75A$
--

**IGBT Half-Bridge  
POWIR 34™ Package**



**Applications:**

- Industrial Motor Drive
- Uninterruptible Power Supply
- Welding and Cutting Machine
- Switched Mode Power Supply
- Induction Heating
- AC Inverter Drive



Features	Benefits
Low $V_{CE(ON)}$ and Switching Losses	High Efficiency in a Wide Range of Applications
100% RBSOA Tested	Rugged Transient Performance
10μsec Short Circuit Safe Operating Area	
<b>POWIR 34™</b> Package	Industry Standard
Lead Free	RoHS Compliant, Environmental Friendly

Base Part Number	Package Type	Standard Pack	Quantity	Orderable Part Number
IRG7T75HF12A	<b>POWIR 34™</b>	Box	80	IRG7T75HF12A

**Absolute Maximum Ratings of IGBT**

$V_{CES}$	Collector to Emitter Voltage	1200	V
$V_{GES}$	Continuous Gate to Emitter Voltage	±20	V
$I_C$	Continuous Collector Current	$T_C = 80^\circ C$	75 A
		$T_C = 25^\circ C$	150 A
$I_{CM}$	Pulse Collector Current	$T_J = 175^\circ C$	150 A
$P_D$	Maximum Power Dissipation (IGBT)	$T_C = 25^\circ C, T_J = 175^\circ C$	450 W
$T_J$	Maximum IGBT Junction Temperature	175	°C
$T_{JOP}$	Maximum Operating Junction Temperature Range	-40 to +150	°C
$T_{stg}$	Storage Temperature	-40 to +125	°C

**Electrical Characteristics of IGBT at  $T_J = 25^\circ\text{C}$  (Unless Otherwise Specified)**

Parameter		Min.	Typ.	Max.	Unit	Test Conditions	
$V_{(BR)CES}$	Collector to Emitter Breakdown Voltage	1200			V	$V_{GE} = 0V, I_C = 1mA$	
$V_{GE(th)}$	Gate Threshold Voltage	5.0	5.8	6.5	V	$I_C = 3.5mA, V_{CE} = V_{GE}$	
$V_{CE(ON)}$	Collector to Emitter Saturation Voltage		1.90	2.20	V	$T_J = 25^\circ\text{C}$	$I_C = 75A, V_{GE} = 15V$
			2.20		V	$T_J = 125^\circ\text{C}$	
$I_{CES}$	Collector to Emitter Leakage Current			1	mA	$V_{GE} = 0V, V_{CE} = V_{CES}$	
$I_{GES}$	Gate to Emitter Leakage Current			400	nA	$V_{GE} = \pm 20V, V_{CE} = 0V$	
$R_{Gint}$	Internal Gate Resistance		2.5		$\Omega$		

**Switching Characteristics of IGBT**

Parameter		Min.	Typ.	Max.	Unit	Test Conditions	
$t_{d(on)}$	Turn-on Delay Time		190		ns	$T_J = 25^\circ\text{C}$	$V_{CC} = 600V, I_C = 75A, R_G = 15\Omega, V_{GE} = \pm 15V, \text{Inductive Load}$
			175			$T_J = 125^\circ\text{C}$	
$t_r$	Rise Time		100		ns	$T_J = 25^\circ\text{C}$	
			110			$T_J = 125^\circ\text{C}$	
$t_{d(off)}$	Turn-off Delay Time		270		ns	$T_J = 25^\circ\text{C}$	
			280			$T_J = 125^\circ\text{C}$	
$t_f$	Fall Time		160		ns	$T_J = 25^\circ\text{C}$	
			240			$T_J = 125^\circ\text{C}$	
$E_{on}$	Turn-on Switching Loss		5.2		mJ	$T_J = 25^\circ\text{C}$	
			6.9			$T_J = 125^\circ\text{C}$	
$E_{off}$	Turn-off Switching Loss		3.6		mJ	$T_J = 25^\circ\text{C}$	
			5.5			$T_J = 125^\circ\text{C}$	
$Q_g$	Total Gate Charge		630		nC	$T_J = 25^\circ\text{C}$	
$C_{ies}$	Input Capacitance		10.4		nF	$V_{CE} = 25V, V_{GE} = 0V, f = 1MHz, T_J = 25^\circ\text{C}$	
$C_{oes}$	Output Capacitance		0.56				
$C_{res}$	Reverse Transfer Capacitance		0.37				
RBSOA	Reverse Bias Safe Operating Area	Trapezoid				$I_C = 150A, V_{CC} = 960V, V_P = 1200V, R_G = 15\Omega, V_{GE} = +15V \text{ to } 0V, T_J = 150^\circ\text{C}$	
SCSOA	Short Circuit Safe Operating Area	10			$\mu\text{s}$	$V_{CC} = 600V, V_{GE} = 15V, T_J = 150^\circ\text{C}$	

**Absolute Maximum Ratings of Freewheeling Diode**

$V_{RRM}$	Repetitive Peak Reverse Voltage	1200	V
$I_F$	Diode Continuous Forward Current, $T_C = 25^\circ\text{C}$	150	A
	Diode Continuous Forward Current, $T_C = 80^\circ\text{C}$	75	
$I_{FM}$	Pulse Diode Current	150	A

**Electrical and Switching Characteristics of Freewheeling Diode**

Parameter		Typ.	Max.	Unit	Test Conditions	
$V_F$	Forward Voltage	2.20	2.70	V	$T_J = 25^\circ\text{C}$	$I_F = 75\text{A}$ , $V_{GE} = 0\text{V}$
		2.40			$T_J = 125^\circ\text{C}$	
$I_{rr}$	Peak Reverse Recovery Current	30		A	$T_J = 25^\circ\text{C}$	$I_F = 75\text{A}$ , $di/dt = 750\text{A}/\mu\text{s}$ , $V_{rr} = 600\text{V}$ , $V_{GE} = -15\text{V}$
		45			$T_J = 125^\circ\text{C}$	
$Q_{rr}$	Reverse Recovery Charge	3.6		$\mu\text{C}$	$T_J = 25^\circ\text{C}$	
		7.4			$T_J = 125^\circ\text{C}$	
$E_{rec}$	Reverse Recovery Energy	1.5		mJ	$T_J = 25^\circ\text{C}$	
		3.3			$T_J = 125^\circ\text{C}$	

**Module Characteristics**

Parameter		Min.	Typ.	Max.	Unit
$V_{iso}$	Isolation Voltage (All Terminals Shorted), $f = 50\text{Hz}$ , 1minute			2500	V
$R_{\theta JC}$	Junction-to-Case (IGBT)		0.33		$^\circ\text{C}/\text{W}$
$R_{\theta JC}$	Junction-to-Case (Diode)		0.56		$^\circ\text{C}/\text{W}$
$R_{\theta CS}$	Case-To-Sink (Conductive Grease Applied)		0.1		$^\circ\text{C}/\text{W}$
M	Power Terminals Screw: M5	3.0		5.0	N·m
M	Mounting Screw: M6	4.0		6.0	N·m
G	Weight		165		g

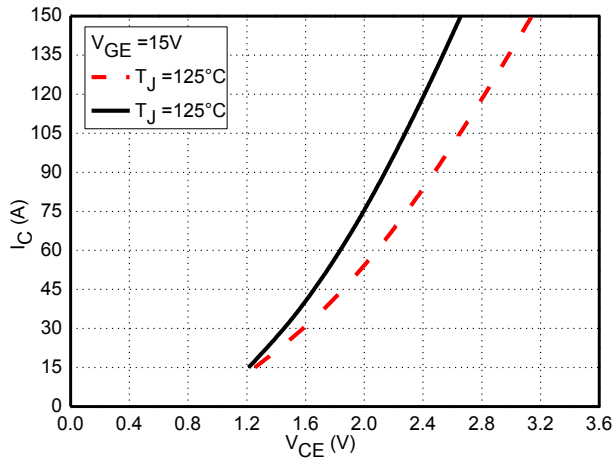


Fig.1 Typical IGBT Saturation Characteristics

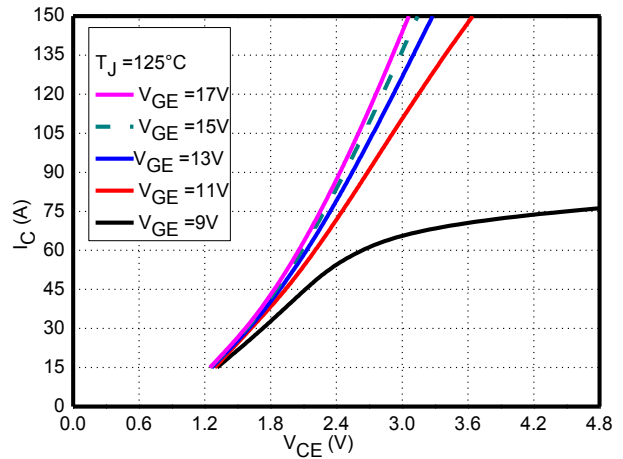


Fig.2 Typical IGBT Output Characteristics

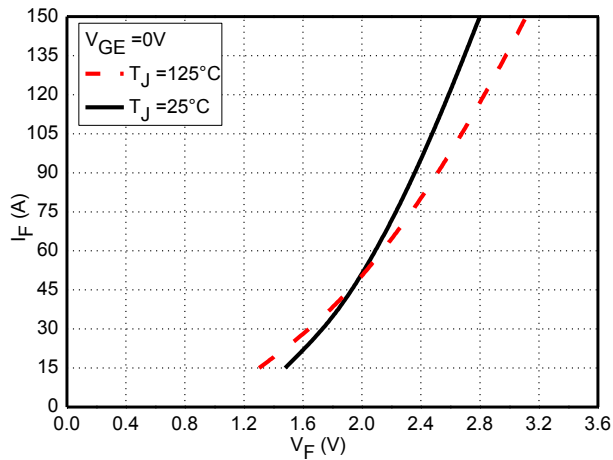


Fig.3 Typical Diode Forward Characteristics

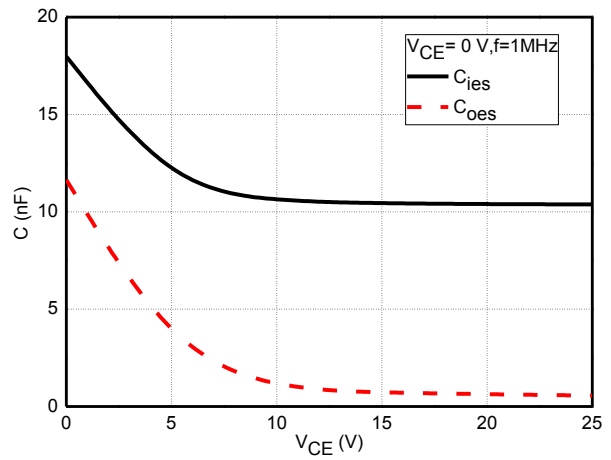


Fig. 4 Typical Capacitance Characteristics

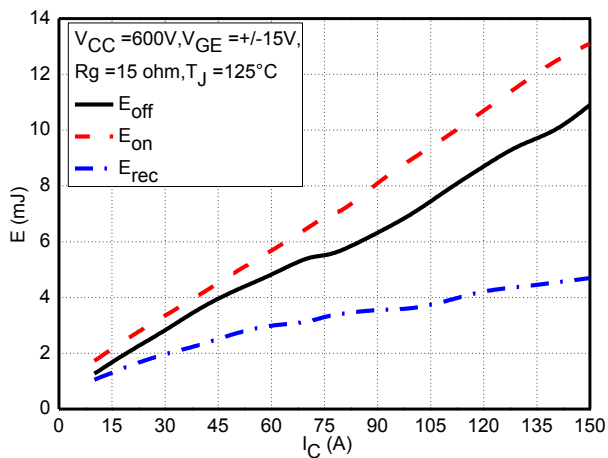


Fig.5 Typical Switching Loss vs. Collector Current

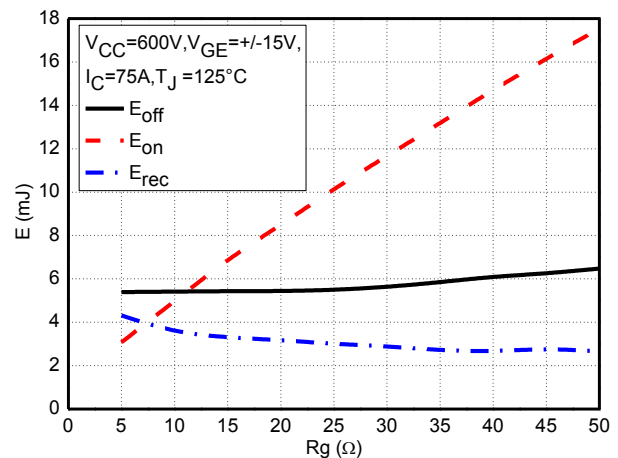
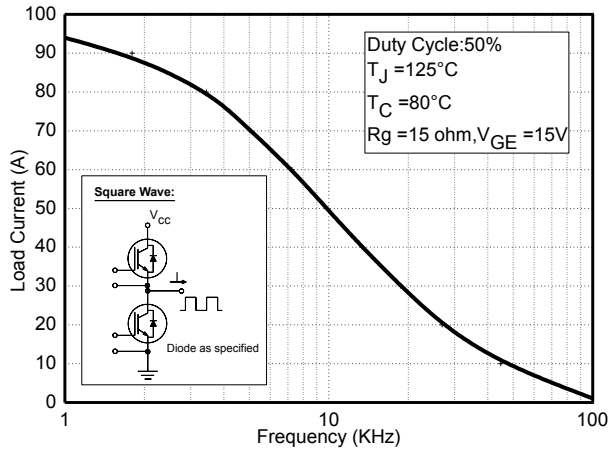
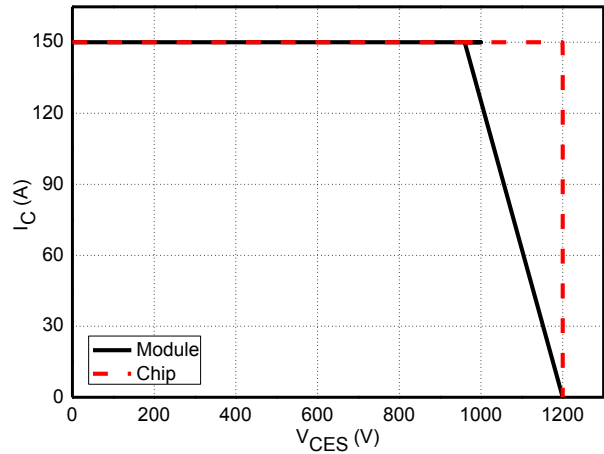


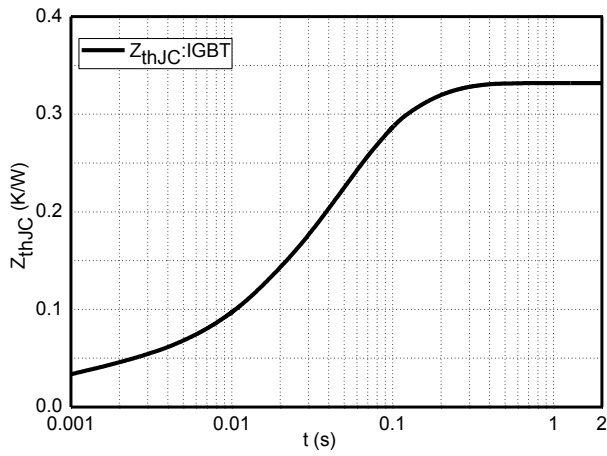
Fig.6 Typical Switching Loss vs. Gate Resistance



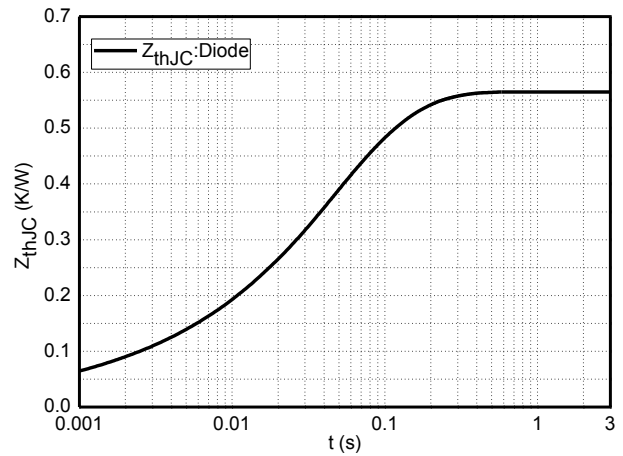
**Fig.7 Typical Load Current vs. Frequency**



**Fig.8 Reverse Bias Safe Operation Area (RBSOA)**

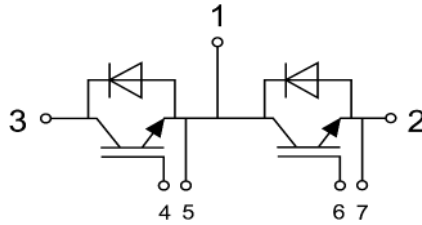


**Fig.9 Typical Transient Thermal Impedance (IGBT)**

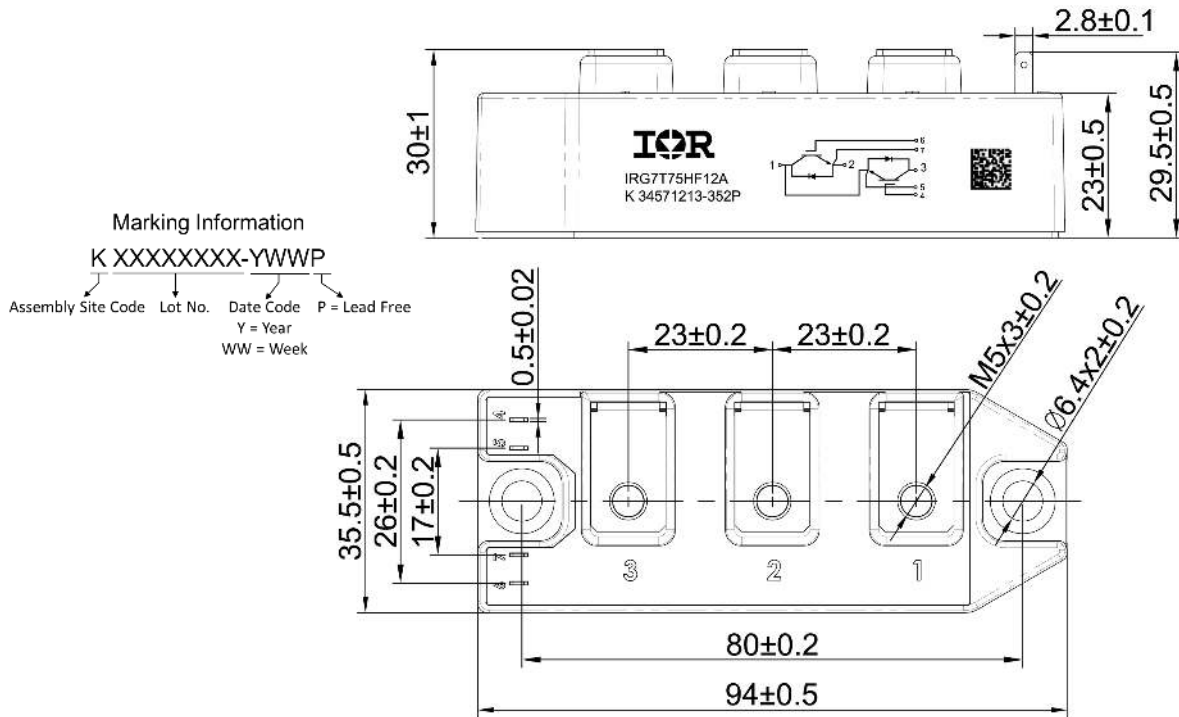


**Fig.10 Typical Transient Thermal Impedance (Diode)**

**Internal Circuit:**



**Package Outline (Unit: mm):**



**Qualification Information†**

Qualification Level	Industrial
Moisture Sensitivity Level	Not Applicable
RoHS Compliant	Yes

† Qualification standards can be found at International Rectifier’s web site: <http://www.irf.com/product-info/reliability/>