



## Alpha 6

Combined 2G/3G & GPS Puck Antenna



### Key Features

- Combined GPS and GSM/GPRS
- Adhesive pad mount
- Groundplane independent

### General Description

Combined quad band GSM/GPS adhesive pad mount antenna for use with tracking and location based applications.

It is a well specified design, which mounts on glass in vehicles and provides good performance.

Supplied as standard with either a 2m or 4m cable. The GPS cable has an SMA Male connector and the GSM cable has an FME female connector.

Alternative cable lengths or connector types can be specified for volume orders.

### Additional Considerations

- Dual antenna package saves cost on purchasing separate antennas
- Fast fit with the adhesive pad mount

2G  
GSM

3G  
UMTS

GPS  
Position



## Alpha 6

Combined 2G/3G & GPS Puck Antenna

### GPS Antenna - Dielectric Antenna

VSWR:	<1.5
Impedance:	50 Ohm
Axial Ratio:	3dB
Gain:	5dBic
Polarization:	RHCP
Center Frequency:	1575.42 + 1MHz

### GPS Antenna - LNA

Gain:	28 + 2dBi
Noise Figure:	<1.5
VSWR:	<2.0
Supply Voltage:	2.5 - 5V DC
Current Consumption:	5 - 15mA

### 2G/3G Antenna

Frequency Range:	824 - 960MHz / 1710-2170MHz
VSWR:	<2.5
Polarization:	Linear
Gain:	2dBi
Impedance:	50 Ohm

### Mechanical Specifications

Connector:	L71.5 x H14.5mm Ø
Connector:	SMA Male GPS FME Female GSM
Cable:	RG174
Radome Material:	ABS
Mounting Method:	Magnet/Adhesive/Screw

### Environmental Specifications

Operating Temperature:	-40 - +85°C
Relative Humidity:	Up to 95%
Mounting Method:	Adhesive

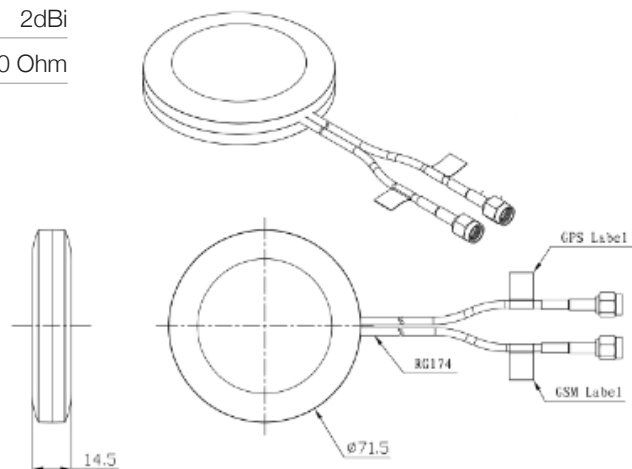



## Alpha 6

Combined 2G/3G & GPS Puck Antenna

GPS Radiation plot XY Plane

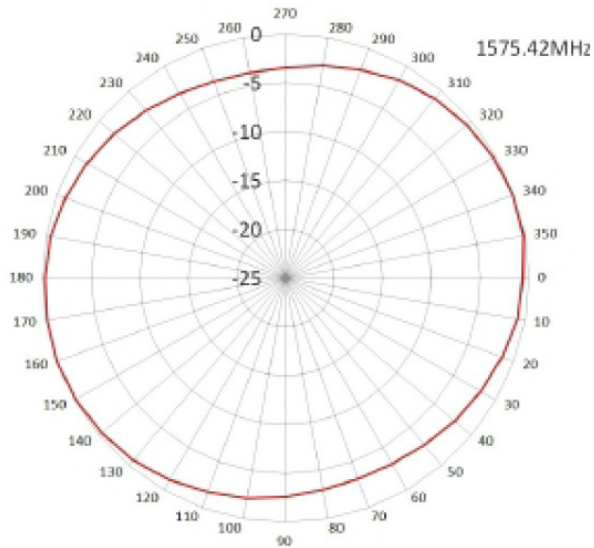

GPS Radiation plot XZ Plane

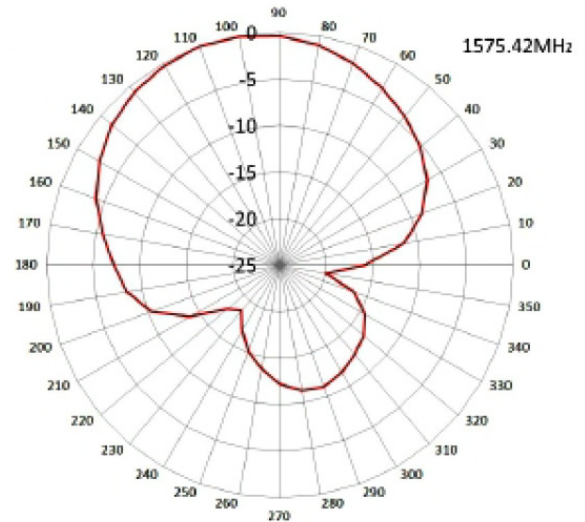

GPS Radiation plot YZ Plane

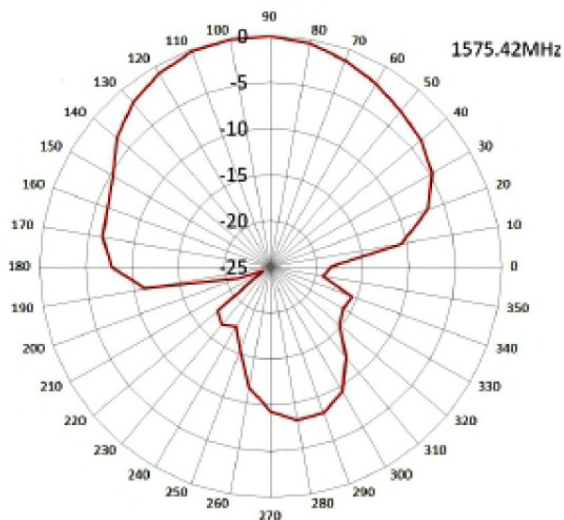



GSM Radiation plot XY Plane

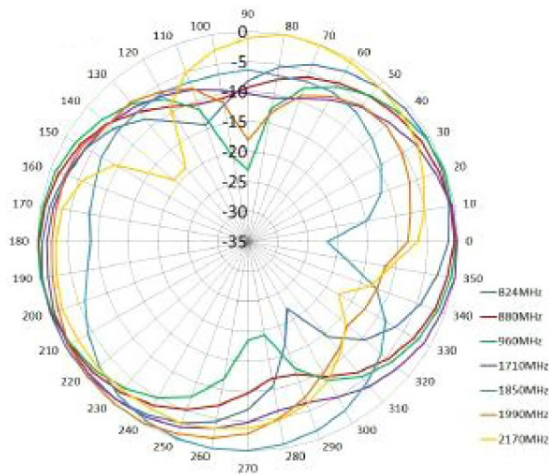

GSM Radiation plot XZ Plane

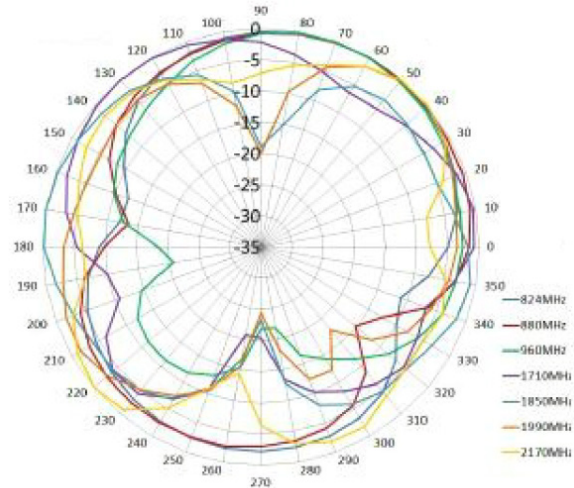

GSM Radiation plot YZ Plane

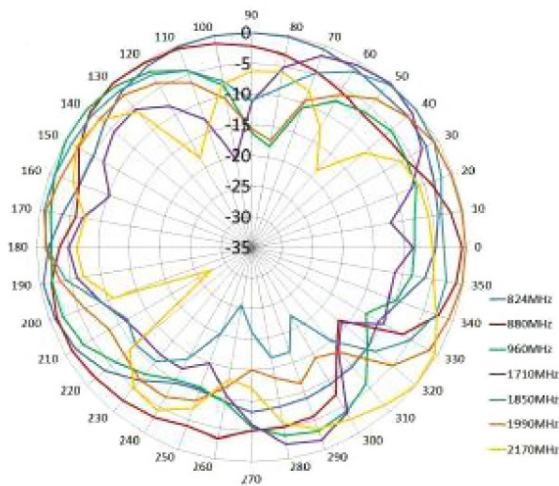

## Ordering Details

Part Number	Description
ALPHA6/2M/SMAM/S/S/FMEF/S/S/7	Combined GSM / GPRS & GPS Puck Antenna 2M FME Female (GSM), SMA Male (GPS)