

**Description:** Wide Band LTE Monopole Antenna

**Series:** Internal PCB Antenna

**PART NUMBER:** W3404SMA



### Features:

- Vertical mount on PCB
- Size W x L x H
  - 42.4 x 31.0 x 0.7mm
- Gain 2.2 / 4.4 dBi
- Efficiency 80 / 66 %
- RoHS compliant
- SMA male connector

### Applications:

- LTE 698-960 MHz, LTE 1710-2690 MHz.
- GSM bands (GSM850, EGSM900, PCN1800, PCS1900), WCDMA band 1
- LTE Cat1M
- NBloT

All dimensions are in mm / inches

Issue: 1924

In the effort to improve our products, we reserve the right to make changes judged to be necessary.

CONFIDENTIAL AND PROPRIETARY INFORMATION

This document contains confidential and proprietary information of Pulse Electronics, Inc. (Pulse) and is protected by copyright, trade secret and other state and federal laws. Its receipt or possession does not convey any rights to reproduce, disclose its contents, or to manufacture, use or sell anything it may describe. Reproduction, disclosure or use without specific written authorization of Pulse is strictly forbidden.

For more information:

Pulse Worldwide Headquarters  
15255 Innovation Drive #100  
San Diego, CA 92128  
USA  
Tel: 1-858-674-8100

Pulse/Larsen Antennas  
18110 SE 34<sup>th</sup> St Bldg 2 Suite 250  
Vancouver, WA 98683  
USA  
Tel: 1-360-944-7551

Europe Headquarters  
Pulse GmbH & Do, KG  
Zeppelinstrasse 15  
Herrenberg, Germany  
Tel: 49 7032 7806 0

Pulse (Suzhou) Wireless Products Co, Inc.  
99 Huo Ju Road(#29 Bldg,4<sup>th</sup> Phase  
Suzhou New District  
Jiangsu Province, Suzhou 215009 PR China  
Tel: 86 512 6807 9998



**Description:** Wide Band LTE Monopole Antenna

**Series:** Internal PCB Antenna

**PART NUMBER:** W3404SMA

### ELECTRICAL SPECIFICATIONS

Antenna Type	Vertical mount monopole
Frequency	698-960/1710-2690 MHz
Nominal Impedance	50 $\Omega$
Return Loss	-10 dB
Radiation Pattern	Omni
Average Total Efficiency (698-960MHz)	80%
Average Total Efficiency (1710-2690MHz)	66%
Peak Gain (698-960MHz)	2.2 dBi
Peak Gain (1710-2690 MHz)	4.4 dBi
Polarization	Linear
Power Withstanding	3W

All RF parameters measured on 70mm X 140mm evaluation board.

**Description:** Wide Band LTE Monopole Antenna

**Series:** Internal PCB Antenna

**PART NUMBER:** W3404SMA

### MECHANICAL SPECIFICATIONS

Overall Length	42.4 x 31.0 x 0.7mm
Antenna Color / Material	PCB black
Connector type	Edge mount SMA Plug
Weight	15g

### ENVIRONMENTAL SPECIFICATIONS

Operating Temperature	40 - 85° C
Storage Temperature	5 - 23° C
RoHS Compliant	Yes

### MECHANICAL DRAWING

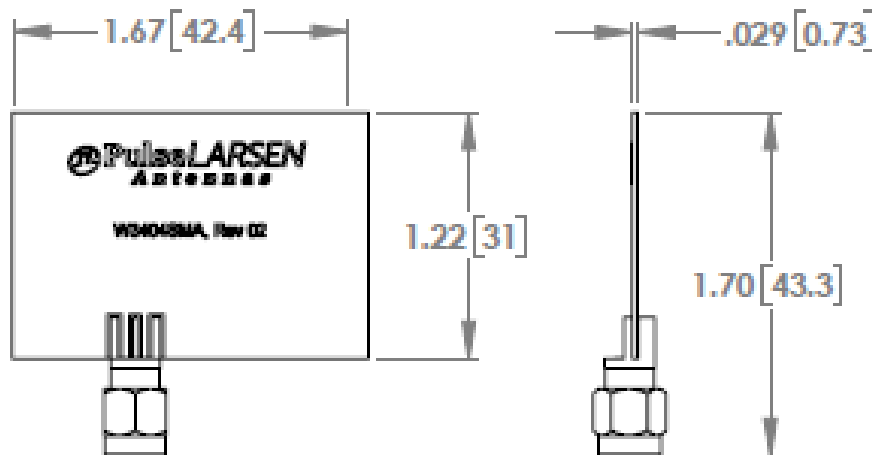

Issue: 1924

In the effort to improve our products, we reserve the right to make changes judged to be necessary.

CONFIDENTIAL AND PROPRIETARY INFORMATION

This document contains confidential and proprietary information of Pulse Electronics, Inc. (Pulse) and is protected by copyright, trade secret and other state and federal laws. Its receipt or possession does not convey any rights to reproduce, disclose its contents, or to manufacture, use or sell anything it may describe. Reproduction, disclosure or use without specific written authorization of Pulse is strictly forbidden.

**Description:** Wide Band LTE Monopole Antenna

**Series:** Internal PCB Antenna

**PART NUMBER:** W3404SMA

**TEST SETUP**

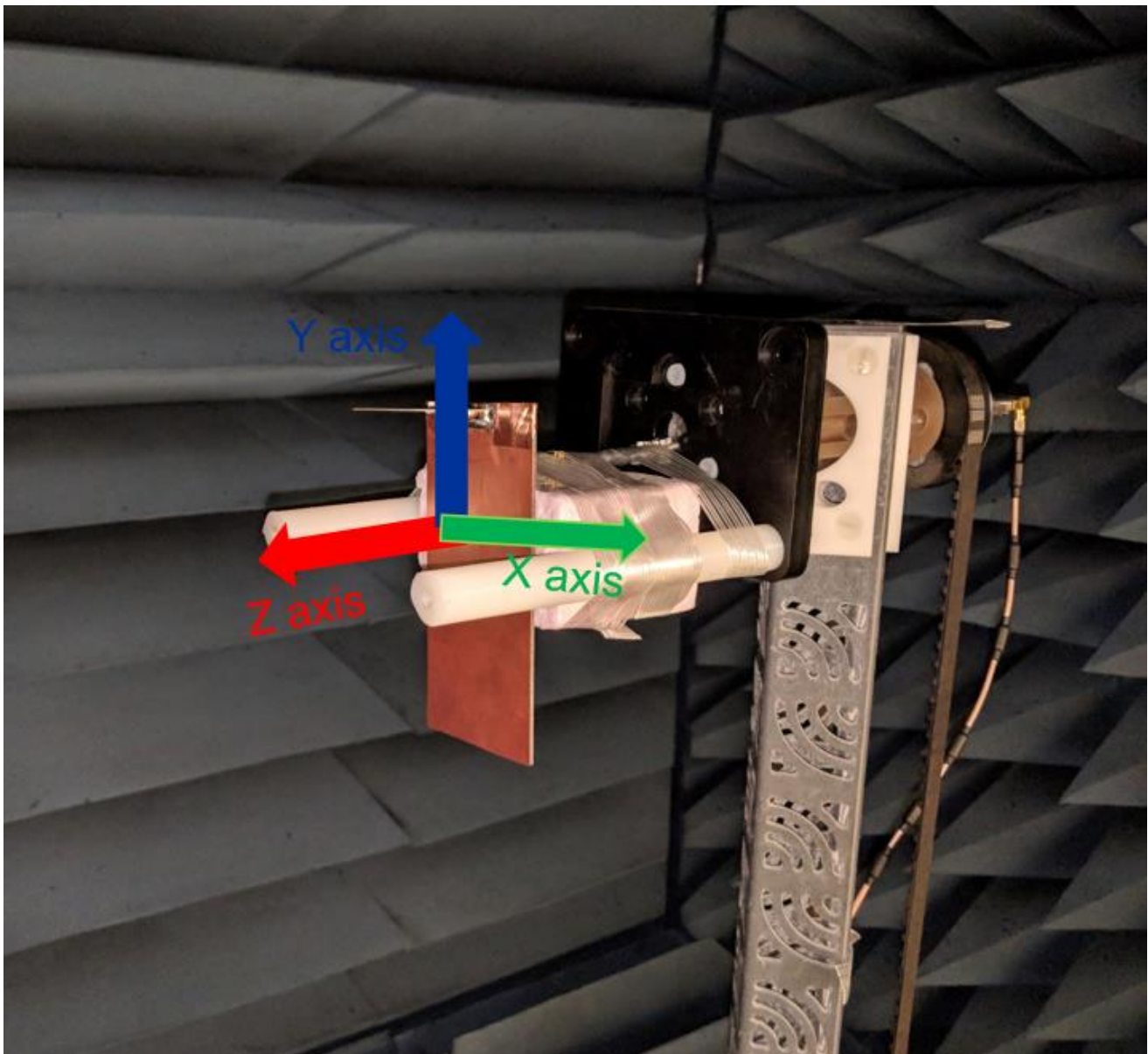

Issue: 1924

In the effort to improve our products, we reserve the right to make changes judged to be necessary.

CONFIDENTIAL AND PROPRIETARY INFORMATION

This document contains confidential and proprietary information of Pulse Electronics, Inc. (Pulse) and is protected by copyright, trade secret and other state and federal laws. Its receipt or possession does not convey any rights to reproduce, disclose its contents, or to manufacture, use or sell anything it may describe. Reproduction, disclosure or use without specific written authorization of Pulse is strictly forbidden.

**Description:** Wide Band LTE Monopole Antenna

**Series:** Internal PCB Antenna

**PART NUMBER:** W3404SMA

CHARTS

Return Loss

Return Loss

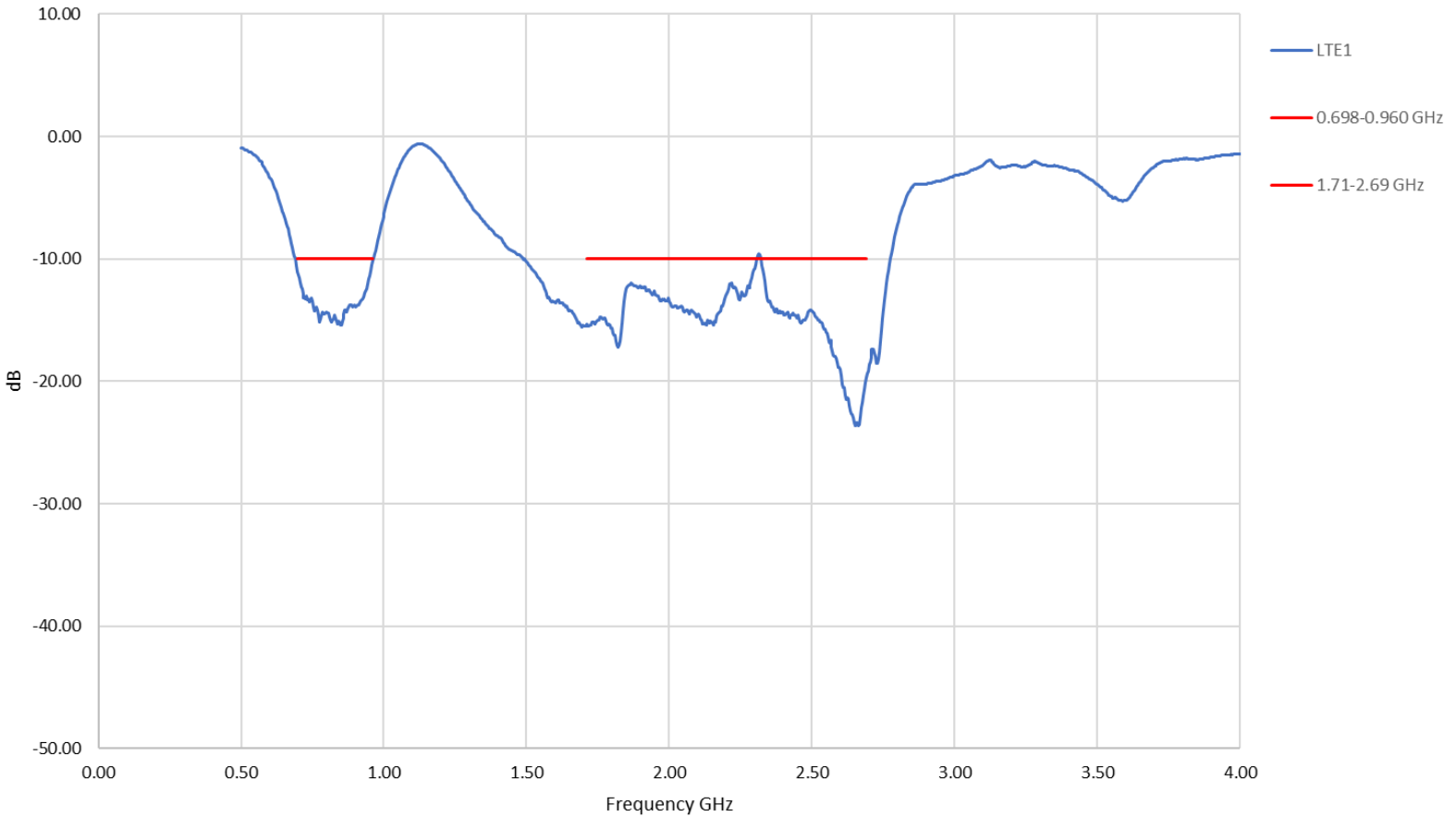

Issue: 1924

In the effort to improve our products, we reserve the right to make changes judged to be necessary.

CONFIDENTIAL AND PROPRIETARY INFORMATION

This document contains confidential and proprietary information of Pulse Electronics, Inc. (Pulse) and is protected by copyright, trade secret and other state and federal laws. Its receipt or possession does not convey any rights to reproduce, disclose its contents, or to manufacture, use or sell anything it may describe. Reproduction, disclosure or use without specific written authorization of Pulse is strictly forbidden.

**Description:** Wide Band LTE Monopole Antenna

**Series:** Internal PCB Antenna

**PART NUMBER:** W3404SMA

CHARTS

**Efficiency %**

**Efficiency vs. Frequency**

Measured at Pulse, USA - Apr. 17, 2018

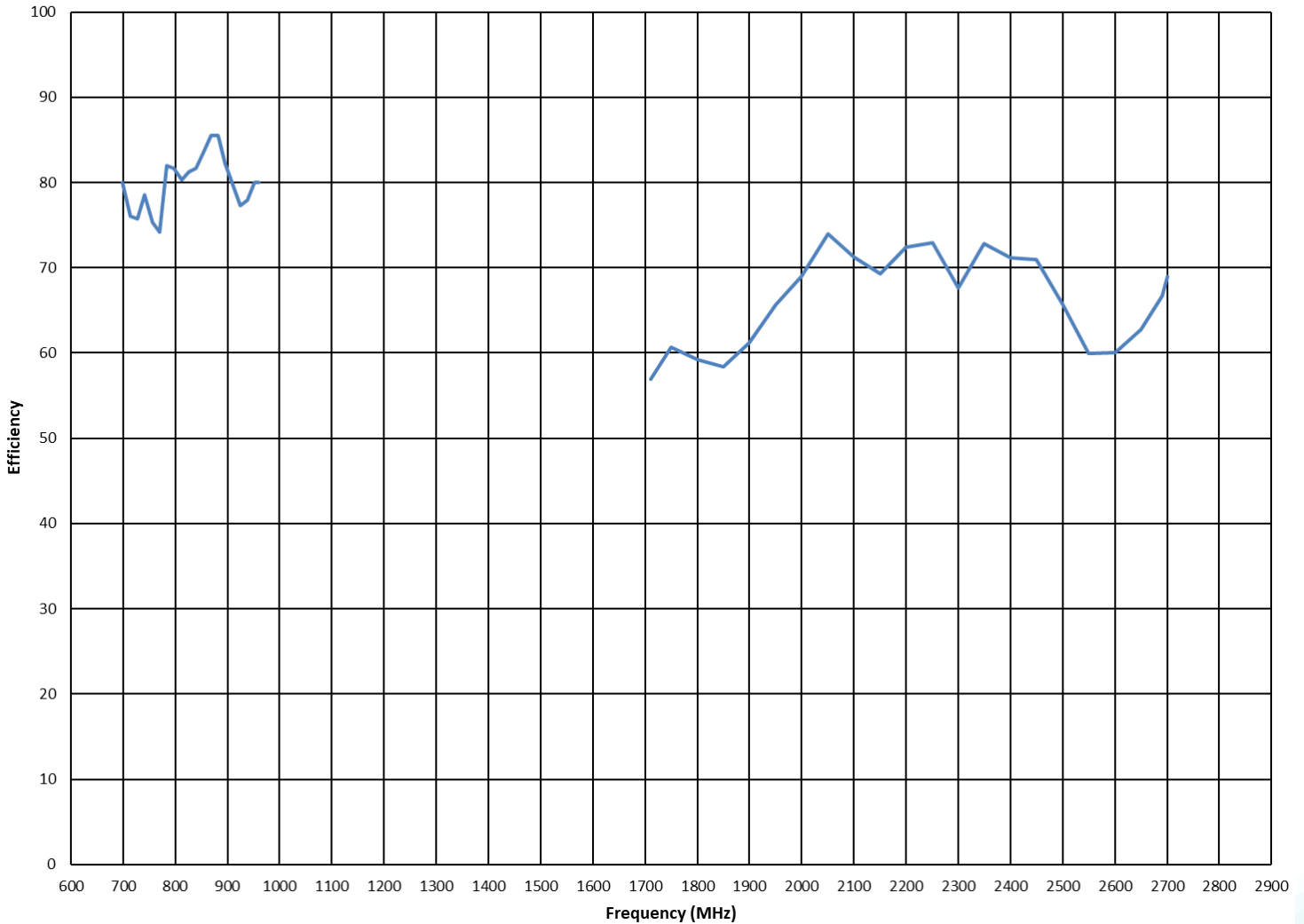

Issue: 1924

In the effort to improve our products, we reserve the right to make changes judged to be necessary.

CONFIDENTIAL AND PROPRIETARY INFORMATION

This document contains confidential and proprietary information of Pulse Electronics, Inc. (Pulse) and is protected by copyright, trade secret and other state and federal laws. Its receipt or possession does not convey any rights to reproduce, disclose its contents, or to manufacture, use or sell anything it may describe. Reproduction, disclosure or use without specific written authorization of Pulse is strictly forbidden.



**Description:** Wide Band LTE Monopole Antenna

**Series:** Internal PCB Antenna

**PART NUMBER:** W3404SMA

CHARTS

Peak Gain

Peak Gain vs. Frequency

Measured at Pulse, USA - Apr. 17, 2018

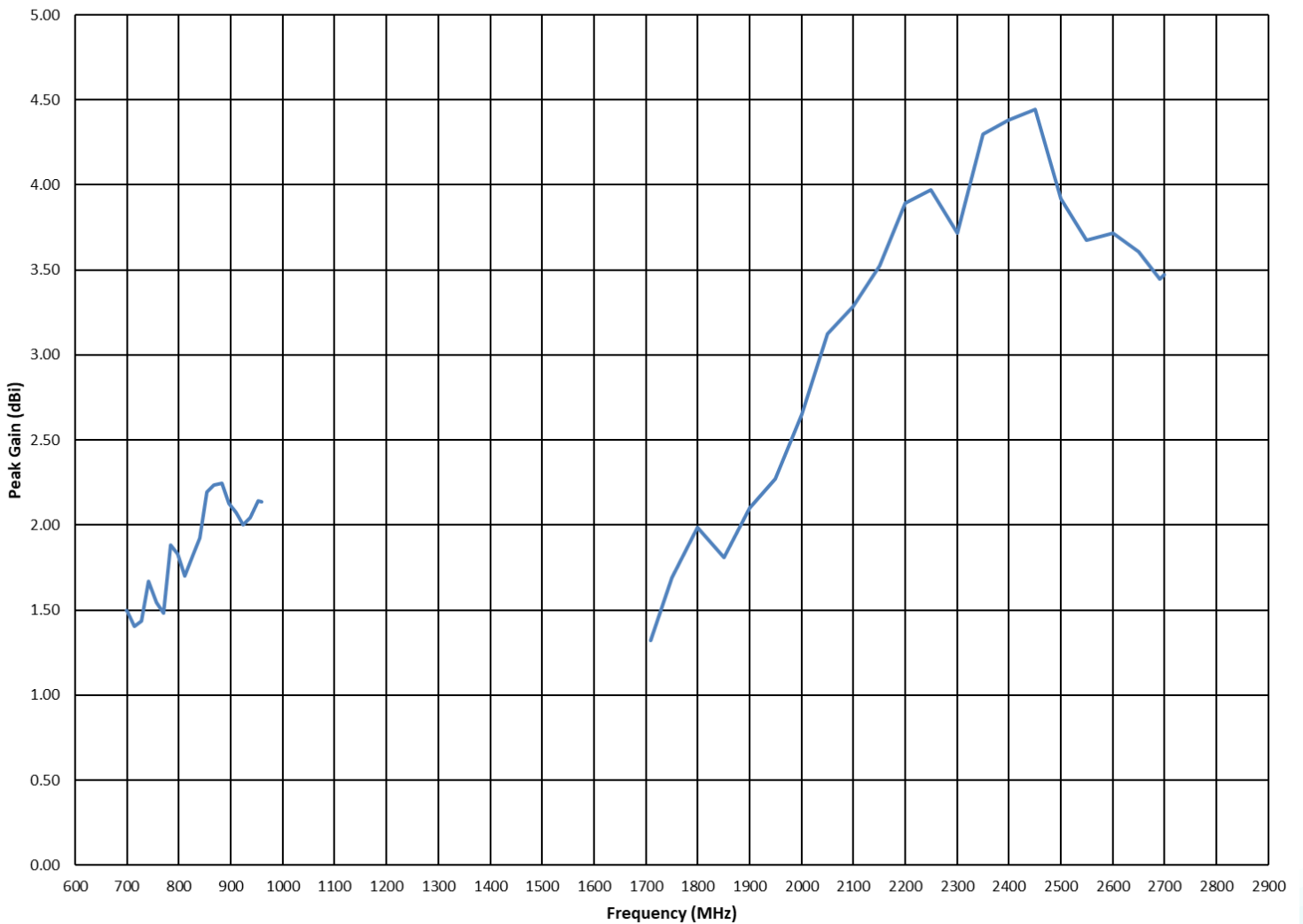

Issue: 1924

In the effort to improve our products, we reserve the right to make changes judged to be necessary.

CONFIDENTIAL AND PROPRIETARY INFORMATION

This document contains confidential and proprietary information of Pulse Electronics, Inc. (Pulse) and is protected by copyright, trade secret and other state and federal laws. Its receipt or possession does not convey any rights to reproduce, disclose its contents, or to manufacture, use or sell anything it may describe. Reproduction, disclosure or use without specific written authorization of Pulse is strictly forbidden.

**Description:** Wide Band LTE Monopole Antenna

**Series:** Internal PCB Antenna

**PART NUMBER:** W3404SMA

**CHARTS**

Free space radiation pattern: 698 MHz- 960 MHz

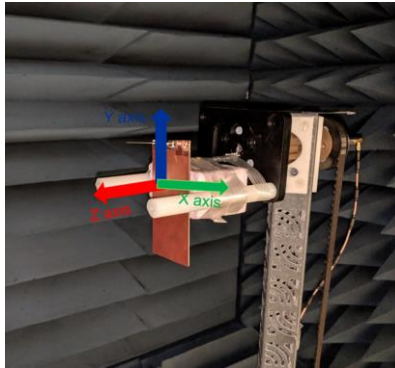

**Horizontal Plane**

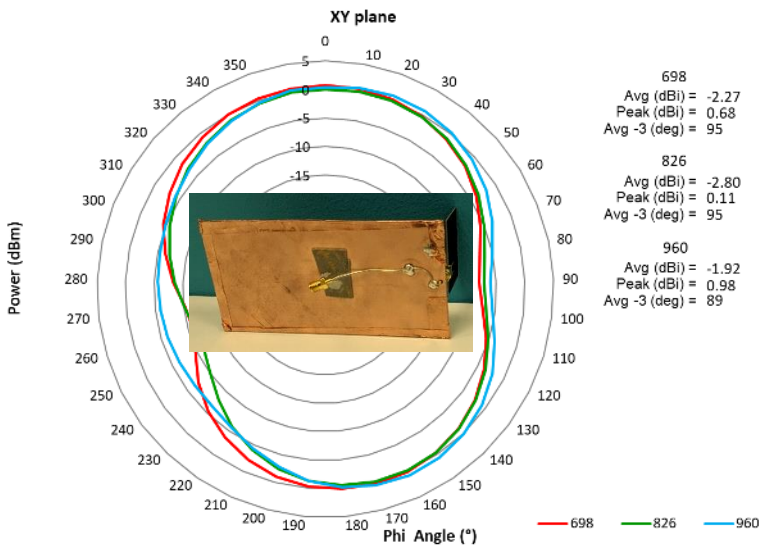

**Elevation Plane**

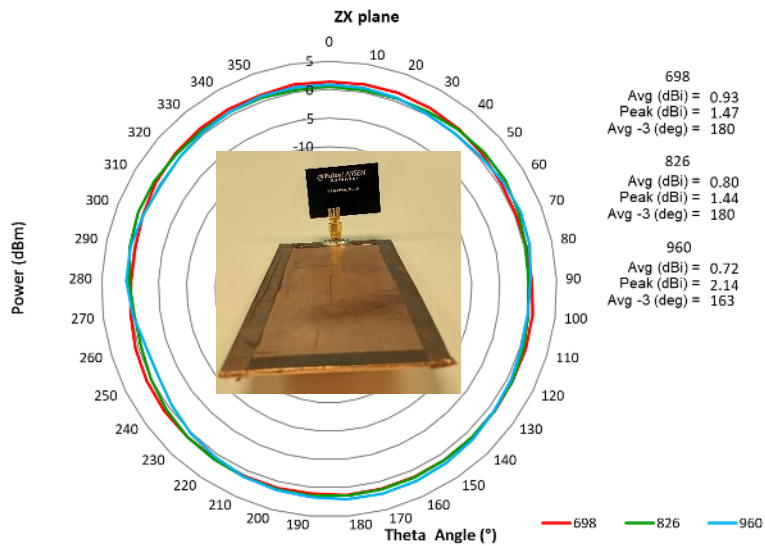

Issue: 1924

In the effort to improve our products, we reserve the right to make changes judged to be necessary.

CONFIDENTIAL AND PROPRIETARY INFORMATION

This document contains confidential and proprietary information of Pulse Electronics, Inc. (Pulse) and is protected by copyright, trade secret and other state and federal laws. Its receipt or possession does not convey any rights to reproduce, disclose its contents, or to manufacture, use or sell anything it may describe. Reproduction, disclosure or use without specific written authorization of Pulse is strictly forbidden.



**Description:** Wide Band LTE Monopole Antenna

**Series:** Internal PCB Antenna

**PART NUMBER:** W3404SMA

**CHARTS**

Free space radiation pattern: 1710 MHz- 2690 MHz

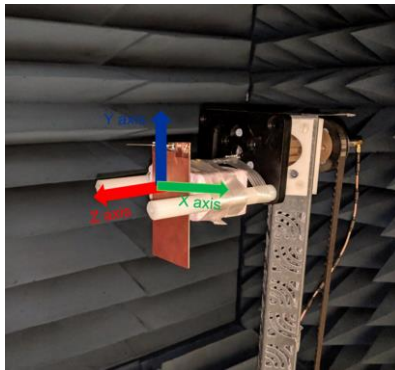

**Horizontal Plane**

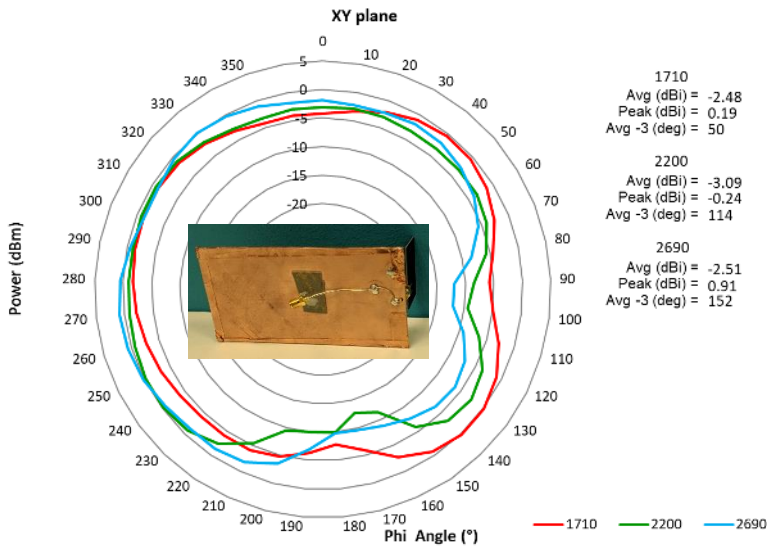

**Elevation Plane**

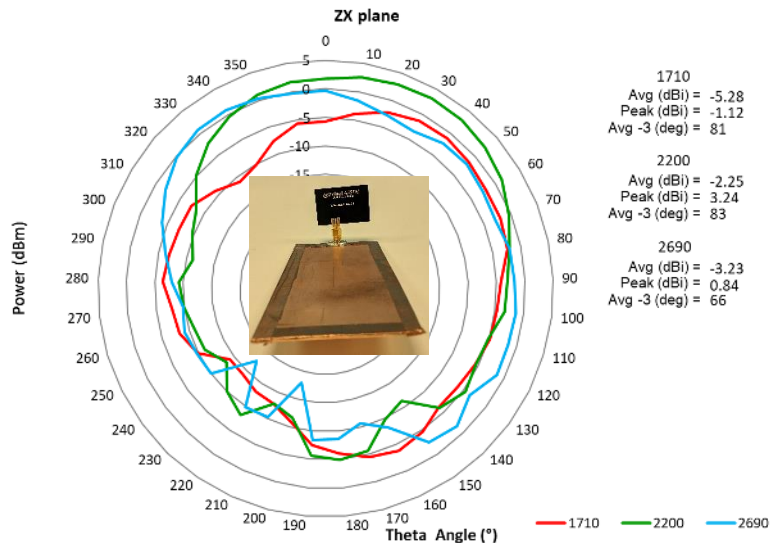

Issue: 1924

In the effort to improve our products, we reserve the right to make changes judged to be necessary.

CONFIDENTIAL AND PROPRIETARY INFORMATION

This document contains confidential and proprietary information of Pulse Electronics, Inc. (Pulse) and is protected by copyright, trade secret and other state and federal laws. Its receipt or possession does not convey any rights to reproduce, disclose its contents, or to manufacture, use or sell anything it may describe. Reproduction, disclosure or use without specific written authorization of Pulse is strictly forbidden.

**Description:** Wide Band LTE Monopole Antenna

**Series:** Internal PCB Antenna

**PART NUMBER:** W3404SMA

## PACKAGING

Per package tray      24pcs product  
Per carton box      19pcs tray + 1pcs extra empty tray  
Total: 456 pcs product  
Big box dimensions (MM): 285x375x200MM