

MATERIAL NO.	# OF CIRC. "XX"	"A"	"B"	"C"	"D"
387307302	2	43.5 (1.71)	11.1 (.44)	33.3 (1.31)	24.5 (.97)
387307303	3	54.6 (2.15)	22.2 (.88)	44.5 (1.75)	35.7 (1.40)
387307304	4	65.7 (2.59)	33.3 (1.31)	55.6 (2.19)	46.8 (1.84)
387307305	5	76.8 (3.03)	44.5 (1.75)	66.7 (2.63)	57.9 (2.28)
387307306	6	87.9 (3.46)	55.6 (2.19)	77.8 (3.06)	69.0 (2.72)
387307307	7	99.1 (3.90)	66.7 (2.63)	88.9 (3.50)	80.1 (3.15)
387307308	8	110.2 (4.39)	77.8 (3.06)	100.0 (3.94)	91.2 (3.59)
387307309	9	121.3 (4.78)	88.9 (3.50)	111.1 (4.38)	102.3 (4.03)
387307310	10	132.4 (5.21)	100.0 (3.94)	122.2 (4.81)	113.4 (4.47)
387307311	11	143.5 (5.65)	111.1 (4.38)	133.4 (5.25)	124.6 (4.90)
387307312	12	154.6 (6.09)	122.2 (4.81)	144.5 (5.69)	135.7 (5.34)
387307313	13	165.7 (6.53)	133.4 (5.25)	155.6 (6.13)	146.8 (5.78)
387307314	14	176.8 (6.96)	144.5 (5.69)	166.7 (6.56)	157.9 (6.22)
387307315	15	188.0 (7.40)	155.6 (6.13)	177.8 (7.00)	169.0 (6.65)
387307316	16	199.1 (7.84)	166.7 (6.56)	188.9 (7.44)	180.1 (7.09)
387307317	17	210.2 (8.28)	177.8 (7.00)	200.0 (7.88)	191.2 (7.53)
387307318	18	221.3 (8.71)	188.9 (7.44)	211.1 (8.31)	202.3 (7.97)
387307319	19	232.4 (9.15)	200.0 (7.88)	222.2 (8.75)	213.5 (8.40)
387307320	20	243.5 (9.59)	211.1 (8.31)	233.4 (9.19)	224.6 (8.84)

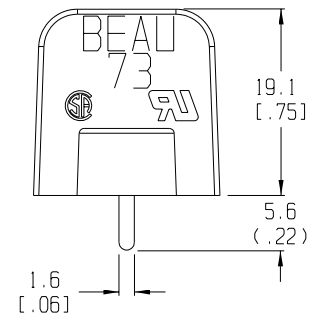
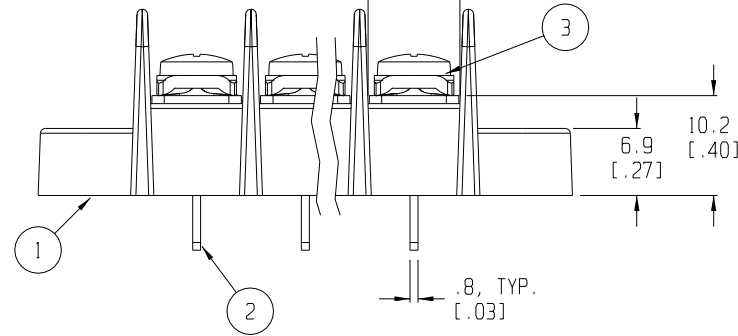

NOTES:

1. MATERIAL: SEE TABLE
2. FINISHES: SEE TABLE
3. PRODUCT SPECIFICATION: NOT REQUIRED
4. PACKAGING: NOT REQUIRED
5. MATES WITH: NONE

PROJECT NO. -	-	-
DIMENSIONS:	SHT	REV
<input checked="" type="checkbox"/> mm <input type="checkbox"/> INCH	<input type="checkbox"/> mm ONLY	REVISE ON CAD ONLY

RELEASED EC NO. DRWN: RK CH'K: APPR: A REV	QUALITY SYMBOLS MAJOR = CRITICAL = SPC =	GENERAL TOLERANCES: (UNLESS SPECIFIED)	SCALE 2:1 DESIGN UNITS <input type="checkbox"/> mm <input checked="" type="checkbox"/> INCH	THIRD ANGLE PROJECTION	TITLE: SR BTS ASY, PC, MTG ENDS W/ SQ WASHER SCREW MOLEX INCORPORATED
		4 PLACES ±.0015 3 PLACES ±.038 ±.005 2 PLACES ±.13 ±.01 1 PLACE ±.3	DRAWN BY & DATE R. KEMP 6-23-03 CHECKED BY & DATE APPROVED BY & DATE	CAD FILENAME 735XX-50	
DRAFT WHERE APPLICABLE MUST REMAIN WITHIN DIMENSIONS			THIS DRAWING CONTAINS INFORMATION THAT IS PROPRIETARY TO MOLEX INCORPORATED AND SHOULD NOT BE USED WITHOUT WRITTEN PERMISSION.		SIZE B

ITEM	QTY.	DESCRIPTION	MATERIAL	FINISH
3	XX	SCREW	STEEL	ZN, CLEAR CHROMATE
2	XX	TERMINAL	BRASS	TIN
1	1	BARRIER	THERMOPLASTIC	BLACK