

General information

Part number	K20KAC-P04LFG0-250S
Termination	solder
Size	0
Locking principle	break , push
Coding	a_key
Cable Diameter	cable_mini_25
Cable outlet	bend_relief

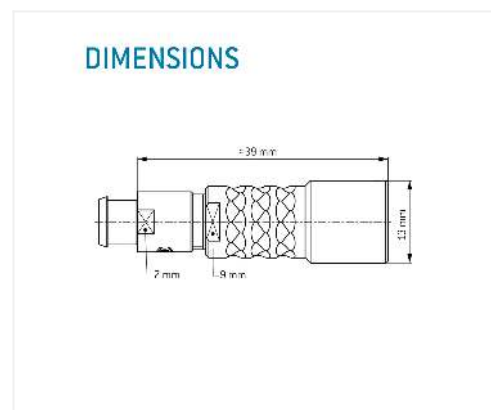

Contact insert description

Number of contacts	4
Contact type	sockets
Contact diameter	07mm
Insulator material	peek
Wire cross section	22_awg
Termination	solder
Termination diameter	085mm
Data transmission	ethernet_100

reverse_gender_on_request

Technical information

Max. creepage and air clearance distance	06_mm	06_mm
Nominal current single contact	075_a	iec_60512_5_2
Nominal current insert	7,5 A	vde_0298_4
Test voltage	09_kv_ac	sae_13441

safety_text

Mechanical and environmental data

Degree of protection*	ip68
-----------------------	------

Operating temperature	40_120_c
-----------------------	----------

Mating cycles	5000
---------------	------

mated

Material and surface treatments

Housing	m_chrome
---------	----------

Contact	cu_alloy_gold
---------	---------------

data_text

safety_text_2

data_text

ul_text

illustrative_text