



Low Skew Output Buffer

General Description

The ICS9112-17 is a high performance, low skew, low jitter zero delay buffer. It uses a phase lock loop (PLL) technology to align, in both phase and frequency, the REF input with the CLKOUT signal. It is designed to distribute high speed clocks in PC systems operating at speeds from 25 to 133 MHz.

ICS9112-17 is a zero delay buffer that provides synchronization between the input and output. The synchronization is established via CLKOUT feed back to the input of the PLL. Since the skew between the input and output is less than +/- 350 pS, the part acts as a zero delay buffer.

The ICS9112-17 has two banks of four outputs controlled by two address lines. Depending on the selected address line, bank B or both banks can be put in a tri-state mode. In this mode, the PLL is still running and only the output buffers are put in a high impedance mode. The test mode shuts off the PLL and connects the input directly to the output buffers (see table below for functionality).

The ICS9112-17 comes in a sixteen pin 150 mil SOIC or 16 pin SSOP package. In the absence of REF input, will be in the power down mode. In this mode, the PLL is turned off and the output buffers are pulled low. Power down mode provides the lowest power consumption for a standby condition.

Features

- Zero input - output delay
- Frequency range 25 - 133 MHz (3.3V)
- High loop filter bandwidth ideal for Spread Spectrum applications.
- Less than 200 ps cycle to cycle Jitter
- Skew controlled outputs
- Skew less than 250 ps between outputs
- Available in 16 pin, 150 mil SSOP & SOIC package

Pin Configuration

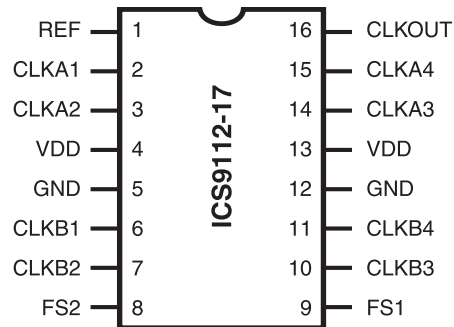

16 pin SSOP & SOIC

Block Diagram

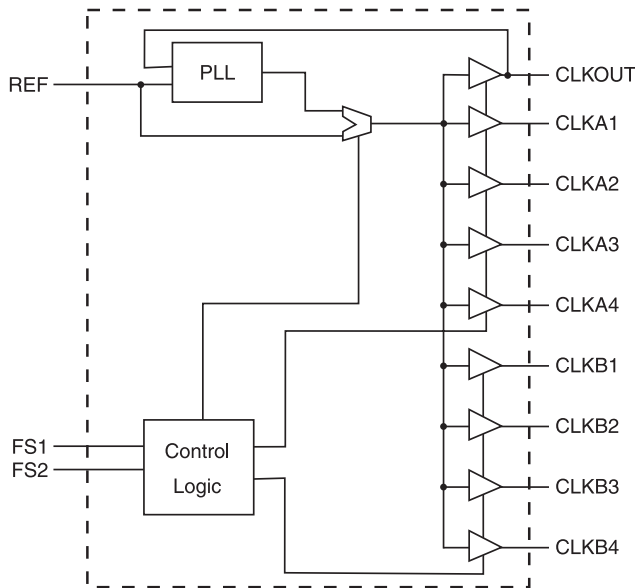

Functionality

FS2	FS1	CLKA (1, 4)	CLKB (1, 4)	CLKOUT	Output Source	PLL Shutdown
0	0	Tristate	Tristate	Driven	PLL	N
0	1	Driven	Tristate	Driven	PLL	N
1	0	PLL Bypass Mode	PLL Bypass Mode	PLL Bypass Mode	REF	Y
1	1	Driven	Driven	Driven	PLL	N



Pin Descriptions

PIN NUMBER	PIN NAME	TYPE	DESCRIPTION
1	REF ²	IN	Input reference frequency.
2	CLKA1 ³	OUT	Buffered clock output, Bank A
3	CLKA2 ³	OUT	Buffered clock output, Bank A
4, 13	VDD	PWR	Power Supply (3.3V)
5, 12	GND	PWR	Ground
6	CLKB1 ³	OUT	Buffered clock output. Bank B
7	CLKB2 ³	OUT	Buffered clock output. Bank B
8	FS2 ⁴	IN	Select input, bit 2
9	FS1 ⁴	IN	Select input, bit 1
10	CLKB3 ³	OUT	Buffered clock output. Bank B
11	CLKB4 ³	OUT	Buffered clock output. Bank B
14	CLKA3 ³	OUT	Buffered clock output, Bank A
15	CLKA4 ³	OUT	Buffered clock output, Bank A
16	CLKOUT ³	OUT	Buffered clock output, internal feedback on this pin

Notes:

1. Guaranteed by design and characterization. Not subject to 100% test.
2. Weak pull-down
3. Weak pull-down on all outputs
4. Weak pull-ups on these inputs



Absolute Maximum Ratings

- Supply Voltage 7.0 V
- Logic Inputs GND -0.5 V to V_{DD} +0.5 V
- Ambient Operating Temperature 0°C to +70°C
- Storage Temperature -65°C to +150°C

Stresses above those listed under *Absolute Maximum Ratings* may cause permanent damage to the device. These ratings are stress specifications only and functional operation of the device at these or any other conditions above those listed in the operational sections of the specifications is not implied. Exposure to absolute maximum rating conditions for extended periods may affect product reliability.

Electrical Characteristics - Input & Supply

T_A = 0 - 70C; Supply Voltage V_{DD} = 5.0 V +/-10% (unless otherwise stated)

PARAMETER	SYMBOL	CONDITIONS	MIN	TYP	MAX	UNITS
Input High Voltage	V _{IH}		2.0	2.5	V _{DD} +0.5	V
Input Low Voltage	V _{IL}		GND -0.5		0.8	V
Input High Current	I _{IH}	V _{IN} = V _{DD}		0.1	100	uA
Input Low Current	I _{IL}	V _{IN} = 0 V;		19	50	uA
Operating current	I _{DD1}	C _L = 0 pF; F _{IN} @ 66M		45	65	mA
Input frequency	F _i ¹	V _{DD} = 3.3 V; All Outputs Loaded	25		133	MHz
Input Capacitance	C _{IN} ¹	Logic Inputs			5	pF

¹ Guaranteed by design, not 100% tested in production.

Electrical Characteristics - Input & Supply

T_A = 0 - 70C; Supply Voltage V_{DD} = 3.3 V +/-10% (unless otherwise stated)

PARAMETER	SYMBOL	CONDITIONS	MIN	TYP	MAX	UNITS
Input High Voltage	V _{IH}		2.0	2.0	V _{DD} +0.3	V
Input Low Voltage	V _{IL}		GND-0.3		0.8	V
Input High Current	I _{IH}	V _{IN} = V _{DD}		0.1	100	uA
Input Low Current	I _{IL}	V _{IN} = 0 V;		19	50	uA
Operating current	I _{DD1}	C _L = 0 pF; F _{IN} @ 66M		30	45	mA
Input frequency	F _i ¹	V _{DD} = 3.3 V; All Outputs Loaded	25		133	MHz
Input Capacitance	C _{IN} ¹	Logic Inputs			5.0	pF

¹Guarenteed by design, not 100% tested in production.



Electrical Characteristics - OUTPUT

$T_A = 0 - 70^\circ\text{C}$; $V_{DD} = V_{DDL} = 5.0 \text{ V} \pm 10\%$; $C_L = 20 - 30 \text{ pF}$ (unless otherwise stated)

PARAMETER	SYMBOL	CONDITIONS	MIN	TYP	MAX	UNITS
Output Impedance	R_{DSP}	$V_O = V_{DD}^*(0.5)$	10		24	Ω
Output Impedance	R_{DSN}	$V_O = V_{DD}^*(0.5)$	10		24	Ω
Output High Voltage	V_{OH}	$I_{OH} = -8 \text{ mA}$	2.4	2.9	5.0	V
Output Low Voltage	V_{OL}	$I_{OL} = 8 \text{ mA}$		0.25	0.4	V
Rise Time ¹	T_r	$V_{OL} = 0.8 \text{ V}, V_{OH} = 2.0 \text{ V}$		0.8	1.5	ns
Fall Time ¹	T_f	$V_{OH} = 2.0 \text{ V}, V_{OL} = 0.8 \text{ V}$		1.0	1.5	ns
PLL Lock Time ¹	tLOCK	Stable power supply, valid clock presented on REF pin			1.0	ms
Duty Cycle ¹	D_t	$V_T = 1.4\text{V}; C_l=30\text{pF}$	40	50	60	%
Cycle to Cycle jitter ¹	Tcyc-cyc	at 66MHz , Loaded Outputs			250	ps
	Tcyc-cyc	>66MHz , Loaded Outputs			200	ps
Absolute Jitter ¹	Tjabs	10000 cycles; $C_l=30\text{pF}$	-100	60	100	ps
Jitter; 1-Sigma ¹	Tj1s	10000 cycles; $C_l=30\text{pF}$		14	30	ps
Skew ¹	T_{sk}	$V_T = 1.4 \text{ V}$ (Window) Output to Output			250	ps
Device to Device Skew ¹	Tdsk-Tdsk	Measured at $V_{DD}/2$ on the CLKOUT pins of devices		0	700	ps
Delay Input-Output ¹	D_{R1}	$V_T = 1.4 \text{ V}$		0	700	ps

¹ Guaranteed by design, not 100% tested in production.

Electrical Characteristics - OUTPUT

$T_A = 0 - 70^\circ\text{C}$; $V_{DD} = V_{DDL} = 3.3 \text{ V} \pm 10\%$; $C_L = 20 - 30 \text{ pF}$ (unless otherwise stated)

PARAMETER	SYMBOL	CONDITIONS	MIN	TYP	MAX	UNITS
Output Impedance	R_{DSP}	$V_O = V_{DD}^*(0.5)$	10		24	Ω
Output Impedance	R_{DSN}	$V_O = V_{DD}^*(0.5)$	10		24	Ω
Output High Voltage	V_{OH}	$I_{OH} = -8 \text{ mA}$	2.4	2.9	3.3	V
Output Low Voltage	V_{OL}	$I_{OL} = 8 \text{ mA}$		0.25	0.4	V
Rise Time ¹	T_r	$V_{OL} = 0.8 \text{ V}, V_{OH} = 2.0 \text{ V}$		1.2	2.0	ns
Fall Time ¹	T_f	$V_{OH} = 2.0 \text{ V}, V_{OL} = 0.8 \text{ V}$		1.2	2.0	ns
PLL Lock Time ¹	tLOCK	Stable power supply, valid clock presented on REF pin			1.0	ms
Duty Cycle ¹	D_t	$V_T = 1.4\text{V}; C_l=30\text{pF}$	40	50	60	%
	D_t	$V_T = V_{DD}/2; F_{out} < 66.6\text{MHz}$	45	50	55	%
Cycle to Cycle jitter ¹	Tcyc-cyc	at 66MHz , Loaded Outputs			250	ps
	Tcyc-cyc	>66MHz , Loaded Outputs			200	ps
Absolute Jitter ¹	Tjabs	10000 cycles; $C_l=30\text{pF}$	-100	70	100	ps
Jitter; 1-Sigma ¹	Tj1s	10000 cycles; $C_l=30\text{pF}$		14	30	ps
Skew ¹	T_{sk}	$V_T = 1.4 \text{ V}$ (Window) Output to Output			250	ps
Device to Device Skew ¹	Tdsk-Tdsk	Measured at $V_{DD}/2$ on the CLKOUT pins of devices		0	700	ps
Delay Input-Output ¹	D_{R1}	$V_T = 1.4 \text{ V}$		0	700	ps

¹ Guaranteed by design, not 100% tested in production.



Output to Output Skew

The skew between CLKOUT and the CLKA/B outputs is not dynamically adjusted by the PLL. Since CLKOUT is one of the inputs to the PLL, zero phase difference is maintained from REF to CLKOUT. If all outputs are equally loaded, zero phase difference will be maintained from REF to all outputs.

If applications requiring zero output-to-output skew, all the outputs must be equally loaded.

If the CLKA/B outputs are less loaded than CLKOUT, CLKA/B outputs will lead it; and if the CLKA/B is more loaded than CLKOUT, CLKA/B will lag the CLKOUT.

Since the CLKOUT and the CLKA/B outputs are identical, they all start at the same time, but different loads cause them to have different rise times and different times crossing the measurement thresholds.

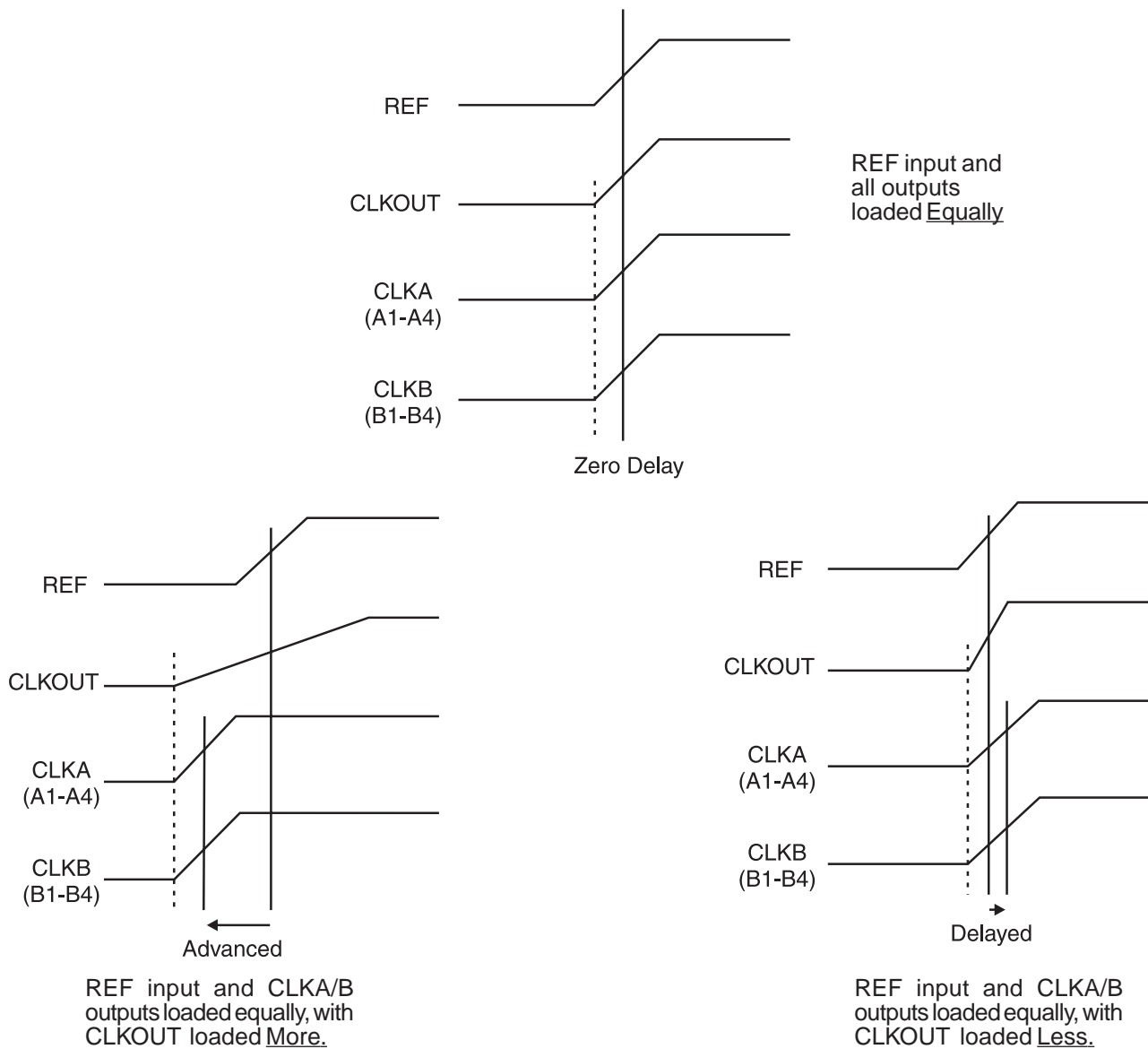



Application Suggestion:

ICS9112-17 is a mixed analog/digital product. The analog portion of the PLL is very sensitive to any random noise generated by charging or discharging of internal or external capacitor on the power supply pins. This type of noise will cause excess jitter to the outputs of ICS9112-17. Below is a recommended lay out to alleviate any addition noise. For additional information on FT. layout, please refer to our AN07. The 0.1 uF capacitors should be connected as close as possible to power pins (4 & 13). An Isolated power plane with a 2.2 uF capacitor to ground will enhance the power line stability.

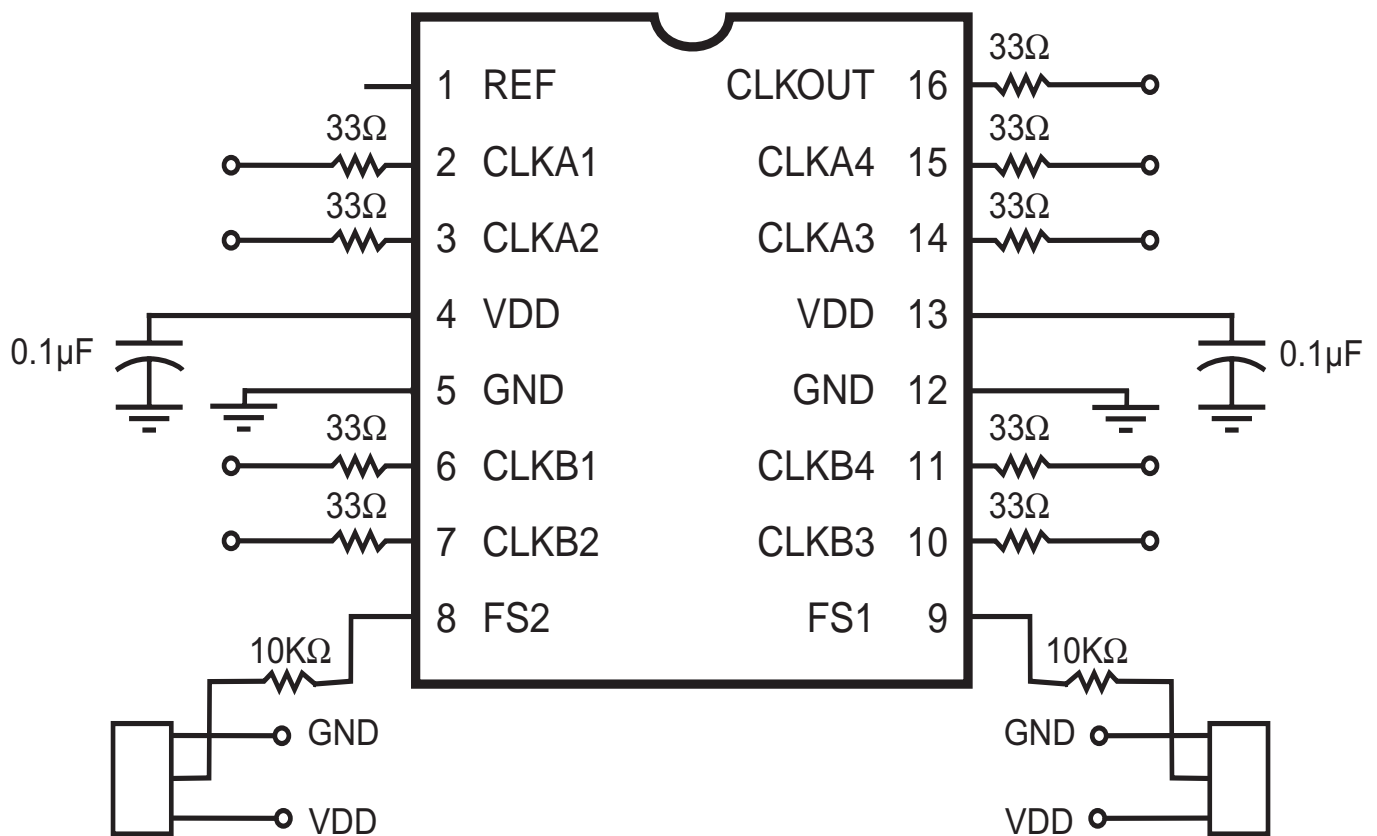

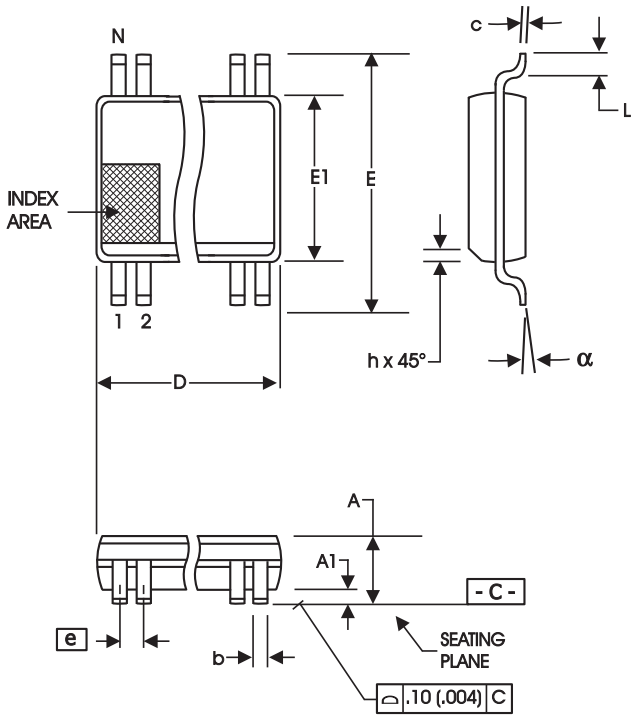

150 mil SSOP (QSOP)

SYMBOL	In Millimeters		In Inches	
	COMMON DIMENSIONS		COMMON DIMENSIONS	
	MIN	MAX	MIN	MAX
A	1.35	1.75	.053	.069
A1	0.10	0.25	.004	.010
A2	--	1.50	--	.059
b	0.20	0.30	.008	.012
c	0.18	0.25	.007	.010
D	SEE VARIATIONS		SEE VARIATIONS	
E	5.80	6.20	.228	.244
E1	3.80	4.00	.150	.157
e	0.635 BASIC		0.025 BASIC	
L	0.40	1.27	.016	.050
N	SEE VARIATIONS		SEE VARIATIONS	
α	0°	8°	0°	8°
ZD	SEE VARIATIONS		SEE VARIATIONS	

VARIATIONS

N	D mm.		ZD (Ref)	D (inch)		ZD (Ref)
	MIN	MAX		MIN	MAX	
16	4.80	5.00	0.23	.189	.197	.009

Reference Doc.: JEDEC Publication 95, MO-137
10-0032

Ordering Information

9112yF-17LF-T

Example:

□ □ □ □ □ y F P R R X X - T

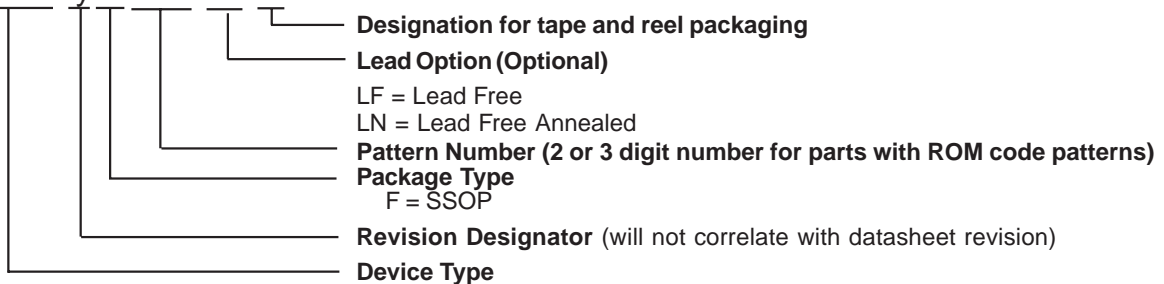

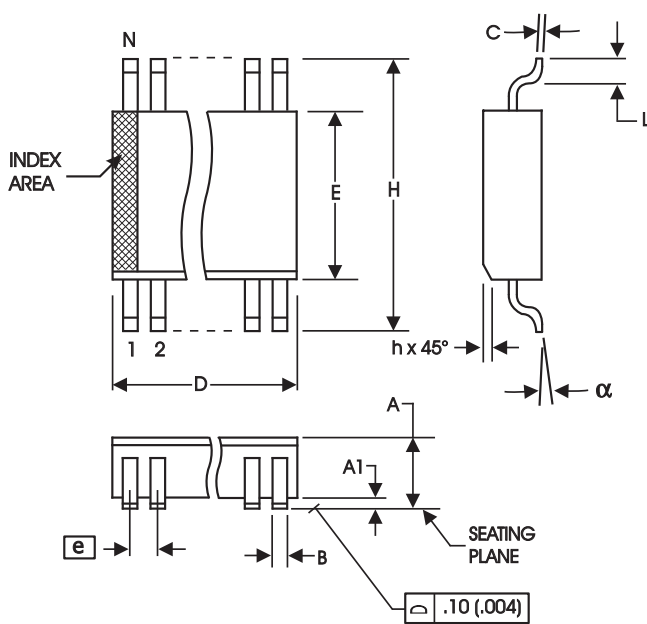

150 mil (Narrow Body) SOIC

SYMBOL	In Millimeters		In Inches	
	COMMON DIMENSIONS	COMMON DIMENSIONS	COMMON DIMENSIONS	COMMON DIMENSIONS
A	1.35	1.75	.0532	.0688
A1	0.10	0.25	.0040	.0098
B	0.33	0.51	.013	.020
C	0.19	0.25	.0075	.0098
D	SEE VARIATIONS		SEE VARIATIONS	
E	3.80	4.00	.1497	.1574
e	1.27 BASIC		0.050 BASIC	
H	5.80	6.20	.2284	.2440
h	0.25	0.50	.010	.020
L	0.40	1.27	.016	.050
N	SEE VARIATIONS		SEE VARIATIONS	
α	0°	8°	0°	8°

VARIATIONS

N	D mm.		D (inch)	
	MIN	MAX	MIN	MAX
16	9.80	10.00	.3859	.3937

Reference Doc.: JEDEC Publication 95, MS-012
10-0030

Ordering Information

9112yM-17LF-T

Example:

□ □ □ □ □ □ M P P P X y T

- □ □ □ □ □ Designation for tape and reel packaging
- Lead Option (Optional)
- LF = Lead Free
- LN = Lead Free Annealed
- P P P X Pattern Number (2 or 3 digit number for parts with ROM code patterns)
- M Package Type
- M = SOIC
- y Revision Designator (will not correlate with datasheet revision)
- T Device Type