

# Diffuse mode sensor OBT200-18GM60-E5-V1



- Dual color indication LED
- High switching frequency
- Light-on/dark-on, programmable
- Strong metallic housing in cylindrical shape M18 x 1
- Degree of protection IP67

Diffuse mode sensor



## Dimensions

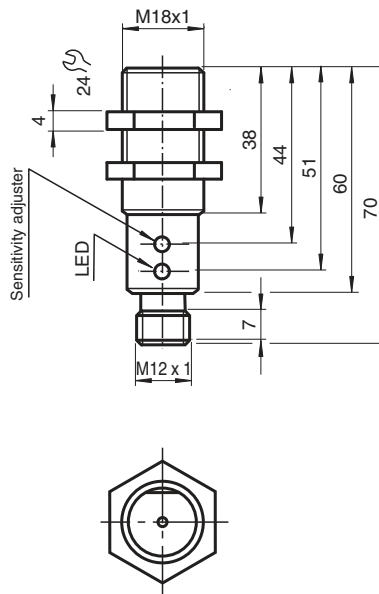

## Technical Data

General specifications		
Detection range		0 ... 200 mm
Reference target		standard white 200 mm x 200 mm
Light source		IRED , 880 nm
Light type		infrared
Diameter of the light spot		approx. 40 mm at 200 mm
Ambient light limit		10000 Lux
Indicators/operating means		
Operation indicator		LED green
Function indicator		Dual color-LED, yellow/green yellow: switch state green: power on flashing: stability control
Control elements		Sensing range adjuster
Electrical specifications		
Operating voltage	$U_B$	10 ... 30 V DC , class 2
Ripple		10 %
No-load supply current	$I_0$	≤ 25 mA
Time delay before availability	$t_v$	≤ 25 ms
Output		
Switching type		light/dark on electrically switchable
Signal output		1 PNP output, short-circuit protected, reverse polarity protected, open collector
Switching voltage		max. 30 V DC
Switching current		max. 100 mA
Voltage drop	$U_d$	≤ 2.5 V
Switching frequency	$f$	500 Hz
Response time		1 ms
Conformity		
Product standard		EN 60947-5-2
Standard conformity		
Standards 2		UL 508
Approvals and certificates		
UL approval		cULus Listed, Type 1 enclosure
CCC approval		CCC approval / marking not required for products rated ≤36 V
Approvals		CE, cULus Listed 57M3 (Only in association with UL Class 2 power supply; Type 1 enclosure)
Ambient conditions		
Ambient temperature		-25 ... 55 °C (-13 ... 131 °F)
Storage temperature		-40 ... 70 °C (-40 ... 158 °F)
Mechanical specifications		
Degree of protection		IP67
Connection		4-pin, M12 x 1 connector
Material		
Housing		brass, nickel-plated
Optical face		PC
Mass		45 g

Release date: 2023-04-04 Date of issue: 2023-04-04 Filename: 087993\_eng.pdf

Refer to "General Notes Relating to Pepperl+Fuchs Product Information".

Pepperl+Fuchs Group  
www.pepperl-fuchs.com

USA: +1 330 486 0001  
fa-info@us.pepperl-fuchs.com

Germany: +49 621 776 1111  
fa-info@de.pepperl-fuchs.com

Singapore: +65 6779 9091  
fa-info@sg.pepperl-fuchs.com

 PEPPERL+FUCHS

## Connection Assignment

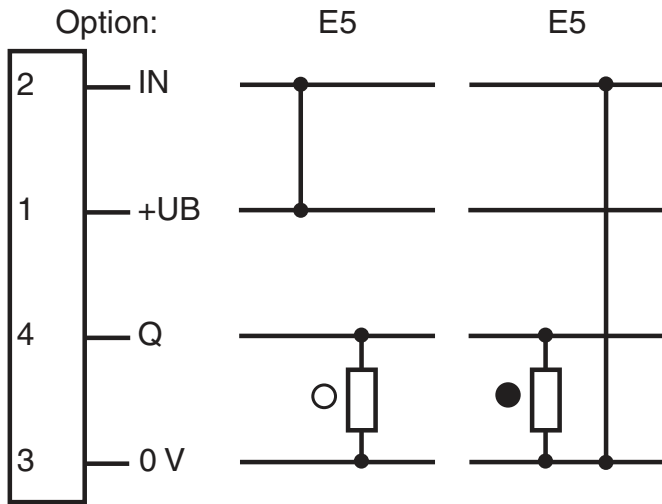

○ = Light on  
● = Dark on

## Connection Assignment

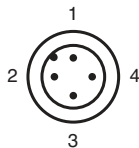

Wire colors in accordance with EN 60947-5-2

1	BN	(brown)
2	WH	(white)
3	BU	(blue)
4	BK	(black)

## Characteristic Curve

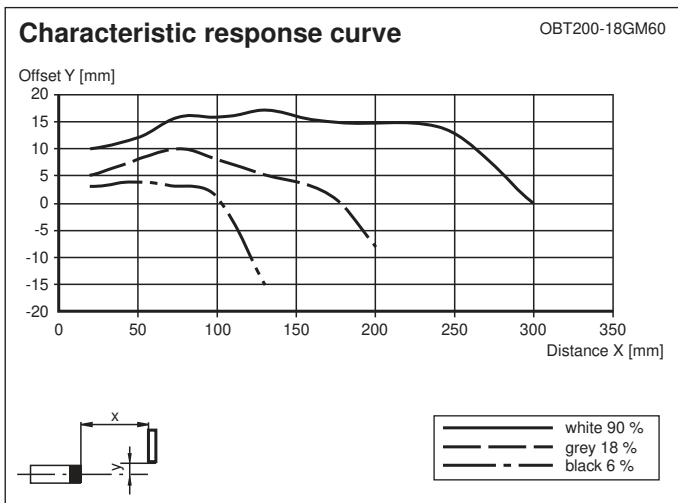

Release date: 2023-04-04 Date of issue: 2023-04-04 Filename: 087993\_eng.pdf

Refer to "General Notes Relating to Pepperl+Fuchs Product Information".

Pepperl+Fuchs Group  
www.pepperl-fuchs.com

USA: +1 330 486 0001  
fa-info@us.pepperl-fuchs.com



Germany: +49 621 776 1111  
fa-info@de.pepperl-fuchs.com

Singapore: +65 6779 9091  
fa-info@sg.pepperl-fuchs.com

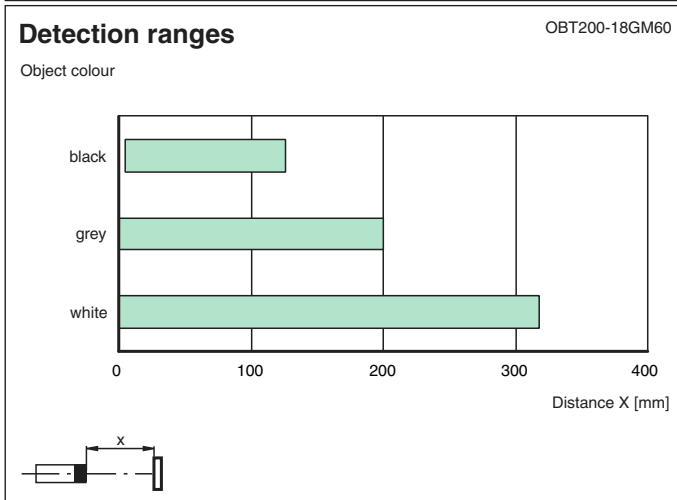
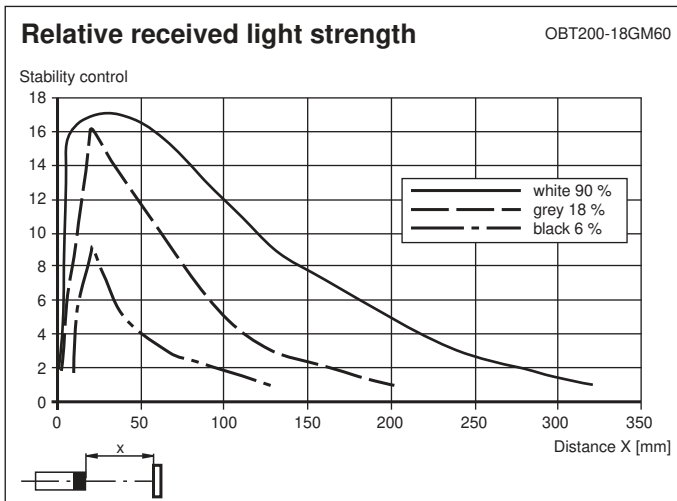
## Characteristic Curve



## Accessories

	<b>V1-G-2M-PUR</b>	Female cordset single-ended M12 straight A-coded, 4-pin, PUR cable grey
	<b>V1-W-2M-PUR</b>	Female cordset single-ended M12 angled A-coded, 4-pin, PUR cable grey

Release date: 2023-04-04 Date of issue: 2023-04-04 Filename: 087993\_eng.pdf