

FAN7548

Dual LCD Back Light Inverter Drive IC

Features

- Backlight Lamp Ballast and Soft Dimming
- Reduce the Number of Components
- Wide Range Operating Voltage 9-30V
- Precision Voltage Reference Trimmed to 3.4%
- Low Standby Current (Typ. 150uA)
- Soft Start Function
- Dual PWM Control
- Analog & Burst Dimming Function
- P-Channel MOSFET Drive
- Open Lamp Regulation(OLR)
- Open Lamp Protection(OLP)
- Buck+Royer Topology
- 20 SSOP

Description

The FAN7548 provides the necessary circuit blocks to implement a highly efficient CCFL backlight power supply in a small footprint 20 SSOP package. The device features two control stages for operating independent resonant tanks for multi-lamp designs.

External parts count is minimized and system cost is reduced by integration such features as a feedback controlled PWM driver stage, the soft start, the open lamp regulation, the open lamp protection, the UVLO, and the self-synchronization circuitry between the buck and Royer stages. It includes an internal shunt regulator, allowing it to operate with input voltage from 9 to 30V. It supports analog and burst dimming modes of operation. It provides the open lamp regulation, and the open lamp protection.



Internal Block Diagram

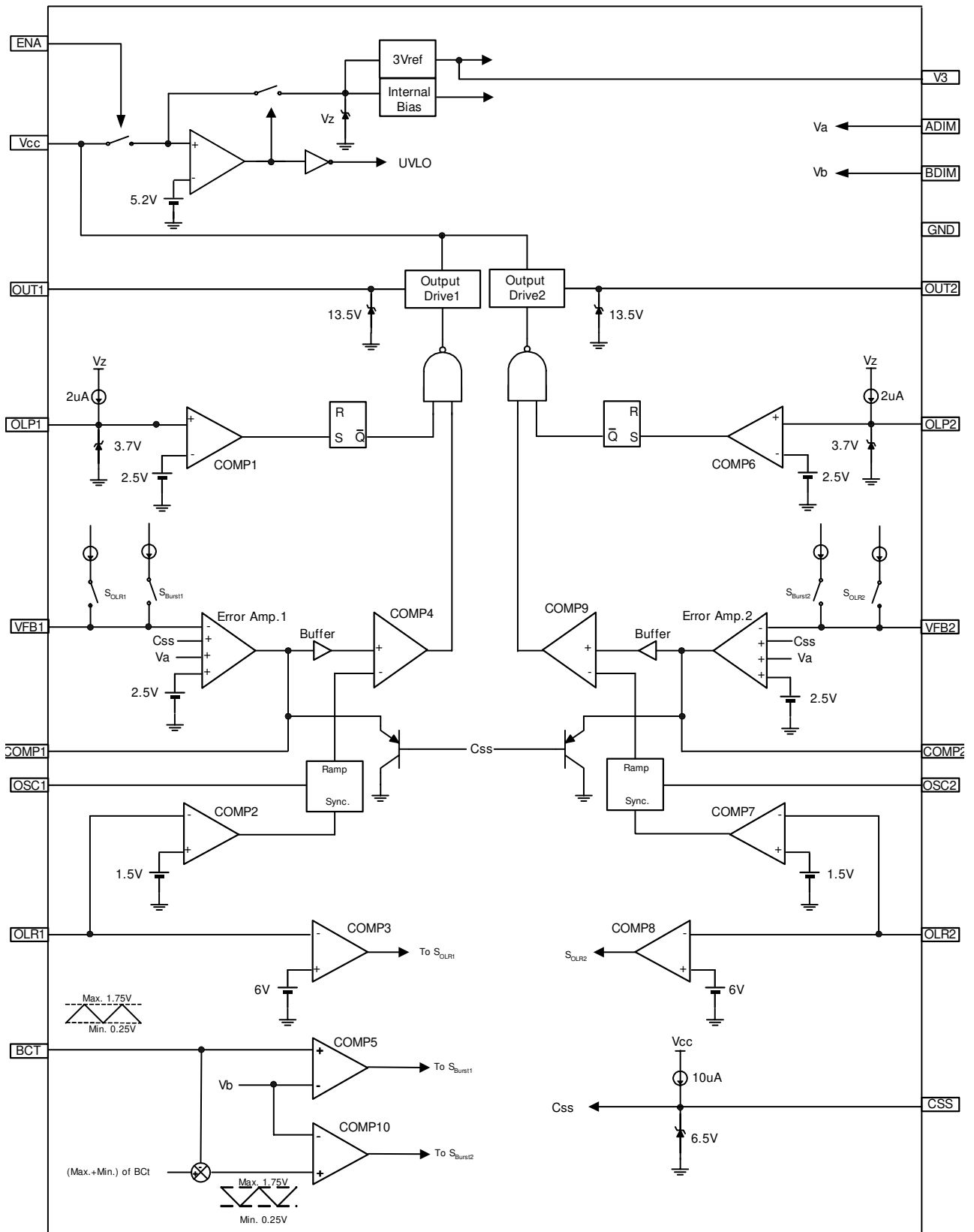

Pin Assignments

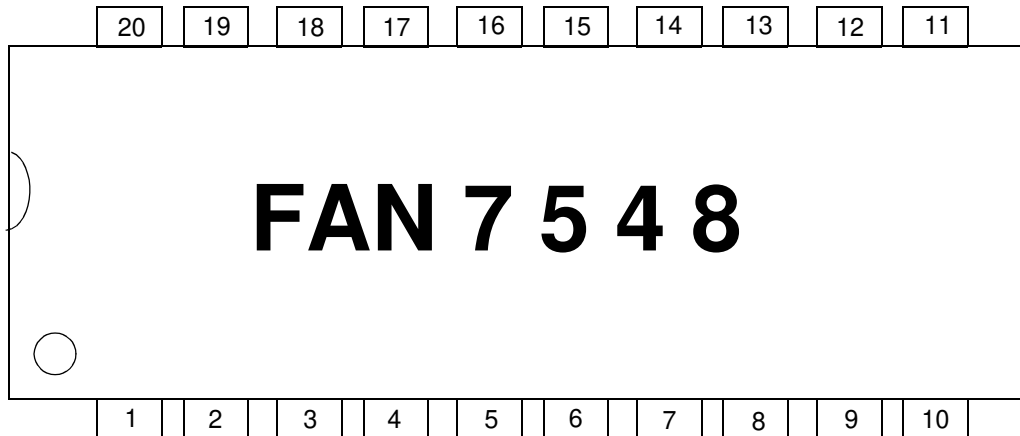

Pin Definitions

No	Name	Function Description	No	Name	Function Description
1	BDIM	Burst Dimming Input	11	OUT2	Gate Drive Output 2
2	BCT	Timing Capacitor for Burst Dimming	12	GND	Ground
3	OLP1	Open Lamp Protection 1	13	CSS	Capacitor for Soft Start
4	VFB1	Error Amp Input 1	14	OSC2	Main Oscillator 2
5	COMP1	Error Amp Output 1	15	OLR2	Open Lamp Regulation 2
6	OLR1	Open Lamp Regulation 1	16	COMP2	Error Amp Output 2
7	OSC1	Main Oscillator 1	17	VFB2	Error Amp Input 2
8	ENA	ON/OFF Control Input	18	OLP2	Open Lamp Protection 2
9	VCC	Power Supply	19	ADIM	Analog Dimming Input
10	OUT1	Gate Drive Output 1	20	V3	3V Reference Voltage

Absolute Maximum Ratings

V_{CC}=12V, T_a=25°C for typical values and -25°C ≤ T_a ≤ 85°C and 9V ≤ V_{CC} ≤ 30V for min/max values, unless otherwise specified.

Characteristics	Symbol	Value	Unit
Supply Voltage	V _{CC}	6~30	V
Operating Temperature Range	T _{opr}	-25 ~ 85	°C
Storage Temperature Range	T _{stg}	-65 ~ 150	°C
Thermal Resistance Junction-Air (Note1,2)	R _{θJA}	112	°C/W
Power Dissipation	P _d	1.1	W

Note:

1. Thermal resistance test board
Size: 76.2mm * 114.3mm * 1.6mm(1S0P)
JEDEC standard: JESD51-3, JESD51-7
2. Assume no ambient airflow

Electrical Characteristics

V_{cc}=12V, T_a=25°C for typical values and -25°C ≤ T_a ≤ 85°C and 9V ≤ V_{cc} ≤ 30V for min/max values, unless otherwise specified.

Characteristics	Symbol	Test Condition	Min.	Typ.	Max.	Unit
ON/OFF SECTION						
On Stage Input Voltage	V _{on}	-	0.7	-	1.7	V
SOFT START SECTION						
Soft Start Charging Current	I _{ss}	C _{ss} =4V	8.5	10	11.5	μA
Soft Start Clamping High Voltage	V _{ssh}	-	5.5	6.5	7.5	V
UVLO SECTION						
Start Up Current	I _{st}	V _{cc} =4.5V	-	100	300	μA
Start Threshold Voltage	V _{st}	-	4.7	5.2	5.7	V
Operating Supply Current	I _{op}	V _{cc} =12V	7	10	13	mA
REFERENCE SECTION						
3V Reference Voltage	V ₃	-	2.88	2.98	3.08	V
Reference Voltage	V _{ref}	-	2.425	2.5	2.575	V
ERROR AMP SECTION						
Output Sink Current	I _{sin}	COMP=3V	-	-	-2	mA
Output Source Current	I _{sur}	COMP=3V	2	-	-	mA
BURST OSCILLATOR SECTION						
Operating Frequency	F _{bosc}	C _t =150n	93	110	127	Hz
Osc High Voltage	V _{bh}	-	-	1.75	-	V
Osc Low Voltage	V _{bl}	-	-	0.25	-	V
PROTECTION SECTION						
Open Lamp Regulation Voltage	V _{or}	-	5.5	6	6.5	V
Open Lamp Protection Voltage	V _{pr}	-	2	2.5	3	V
Open Lamp Protection Current	I _{pr}	-	-	2.5	-	μA
OUTPUT SECTION						
Output High Voltage	V _{oh}	V _{cc} =12V	10	-	-	V
Output Low Voltage	V _{ol}	V _{cc} =12V	-	-	0.2	V
Output Clamping High Voltage	V _{och}	V _{CC} = 15V	11.5	13.5	15.5	V
Output Voltage with UVLO Activated	V _{uv}	V _{CC} = 4V	2	-	4	V
Rising Time	T _r	V _{CC} = 12V	-	150	200	ns
Falling Time	T _f	V _{CC} = 12V	-	100	150	ns

Typical Characteristics

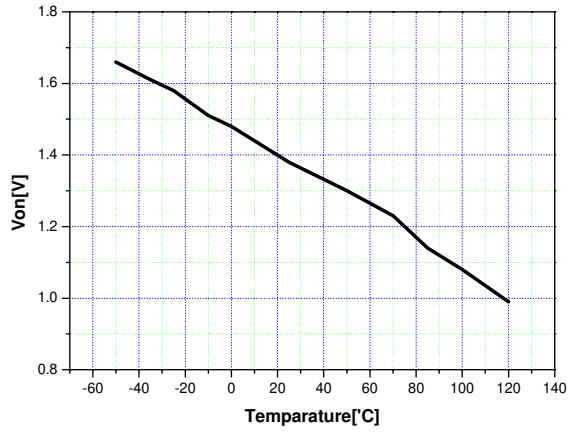

Figure 1. On Stage Input Supply Voltage

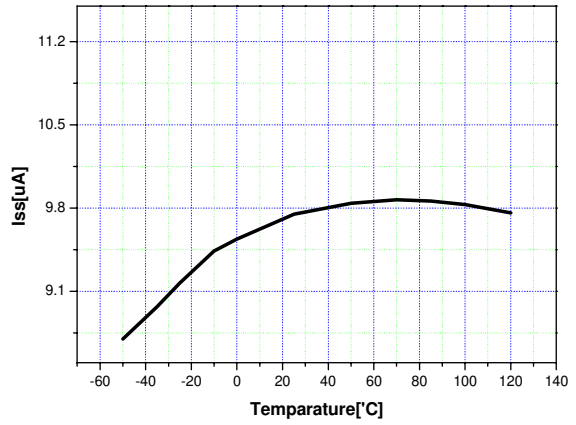

Figure 2. Soft Start Changing Current

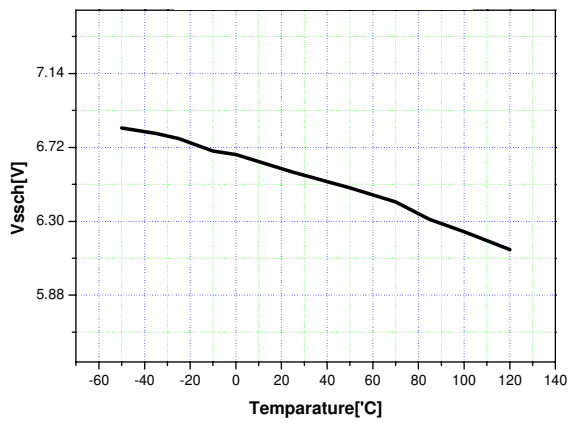

Figure 3. Soft Start Clamping High Voltage

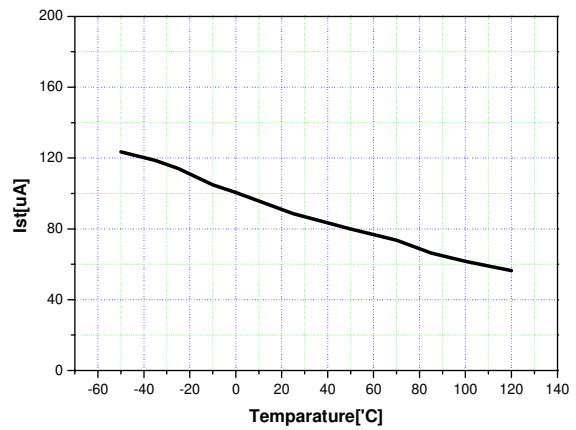

Figure 4. Start Up Current

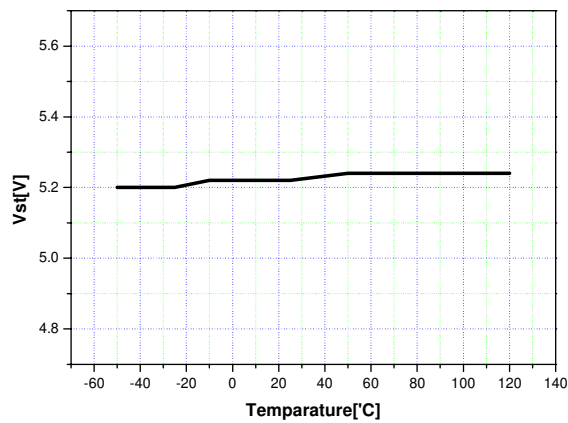

Figure 5. Startup Thresh Hold Voltage

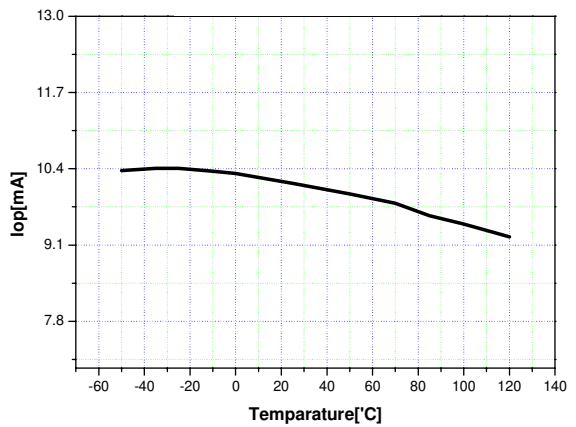

Figure 6. Operating Supply Current

Typical Characteristics (Continued)

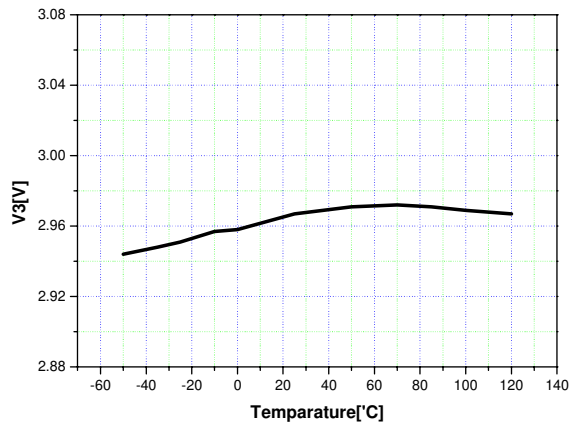

Figure 7. 3V Reference Voltage

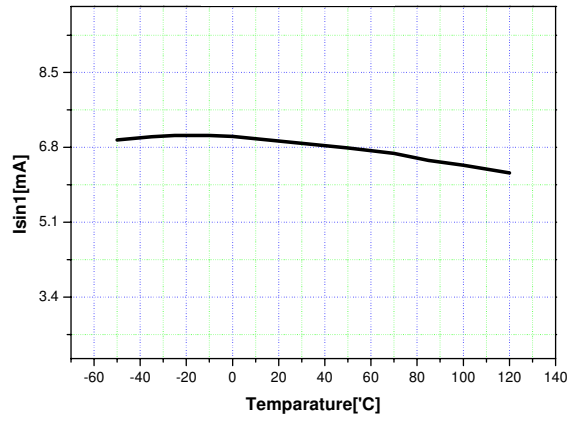

Figure 8. Output Sink Current 1

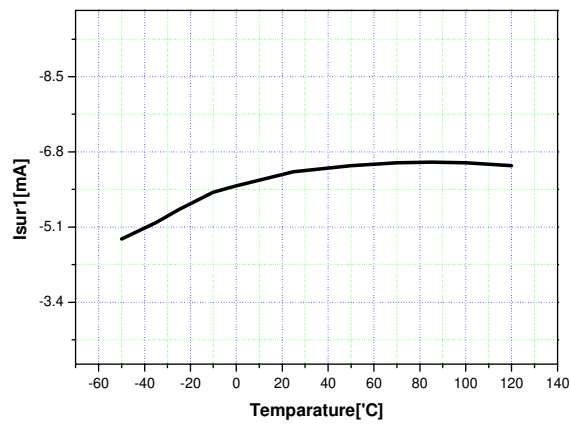

Figure 9. Output Source Current 1

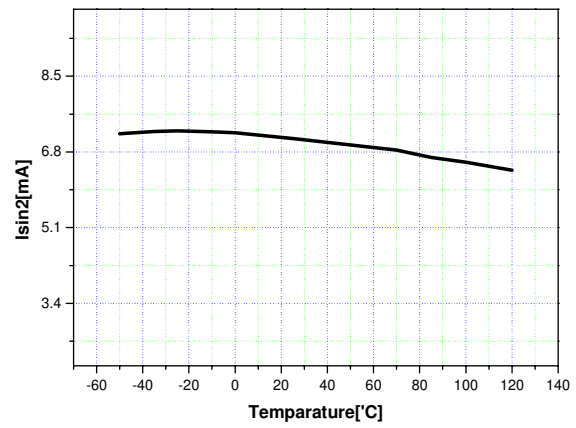

Figure 10. Output Sink Current 2

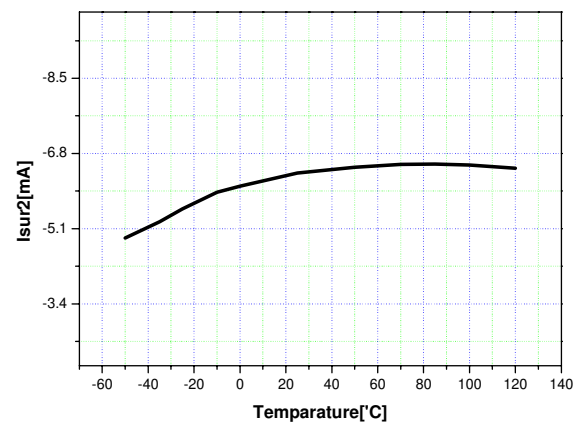

Figure 11. Output Source Current 2

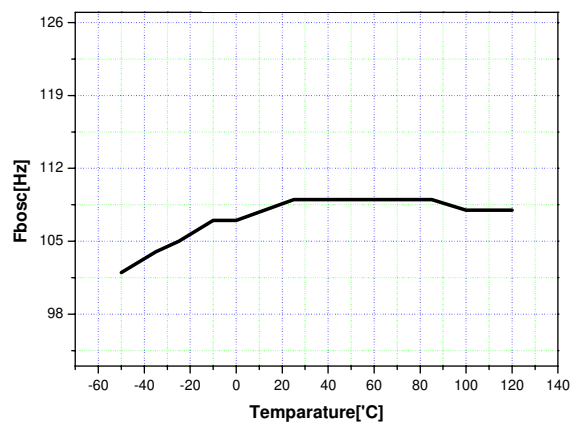

Figure 12. Operating Frequency

Typical Characteristics (Continued)

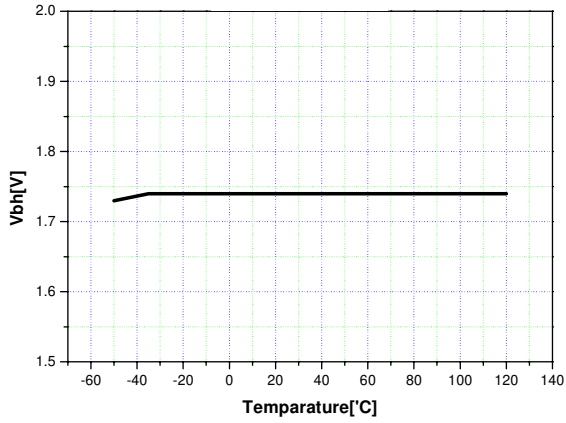

Figure 13. OSC High Voltage

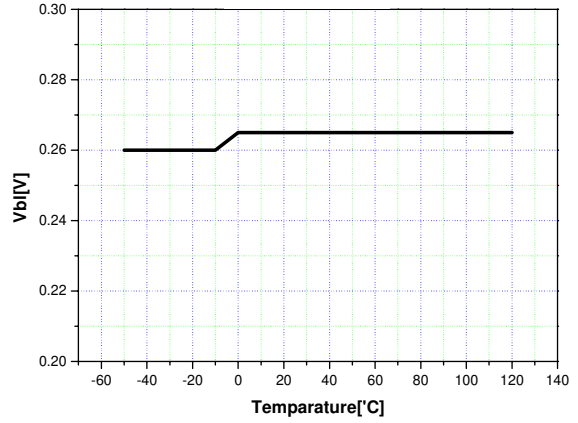

Figure 14. OSC Low Voltage

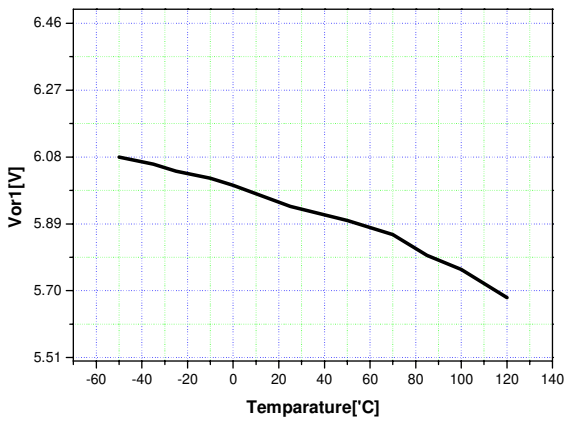

Figure 15. Open Lamp Regulation Voltage 1

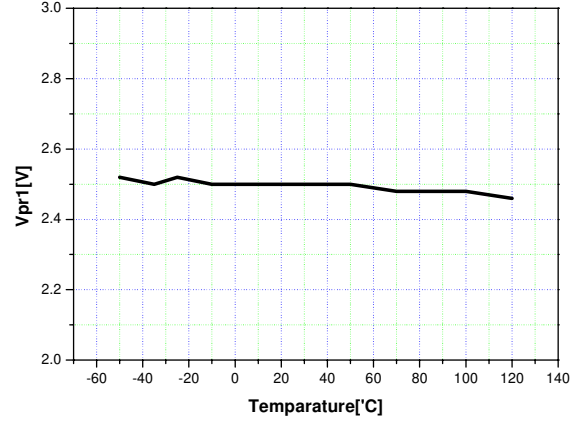

Figure 16. Open Lamp Protection Voltage 1

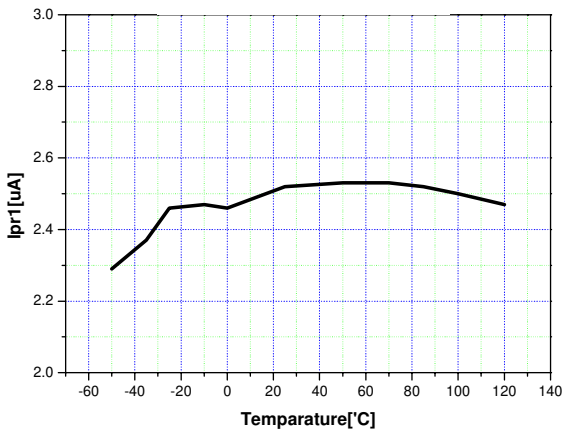

Figure 17. Open Lamp Protection Current 1

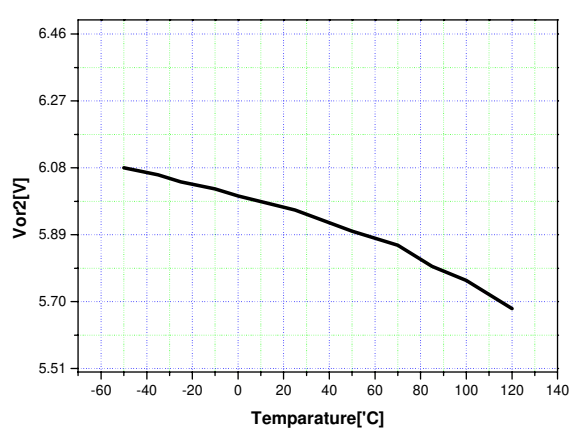

Figure 18. Open Lamp Regulation Voltage 2

Typical Characteristics (Continued)

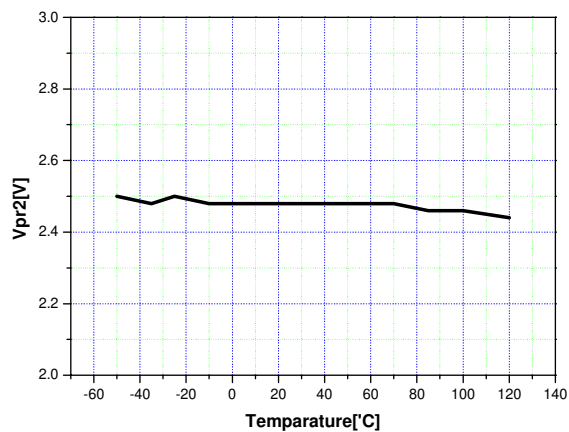

Figure 19. Open Lamp Protection Voltage 2

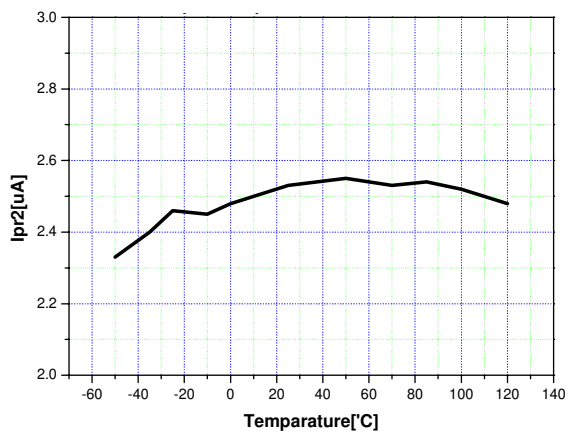

Figure 20. Open Lamp Protection Current 2

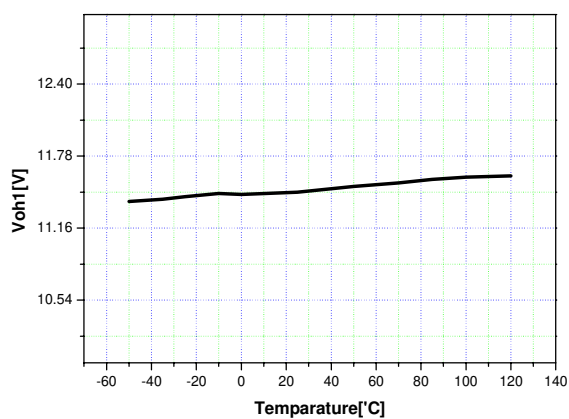

Figure 21. Output High Voltage 1

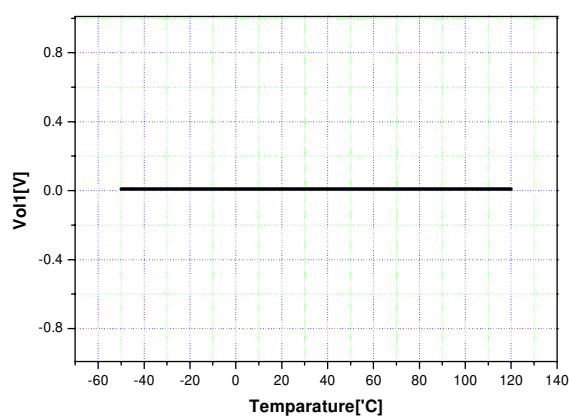

Figure 22. Output Low Voltage 1

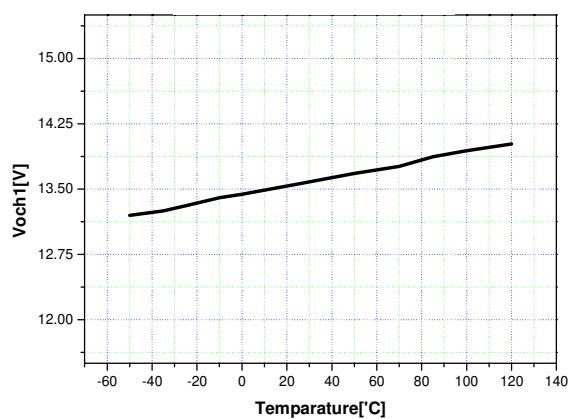

Figure 23. Output Clamping High Voltage 1

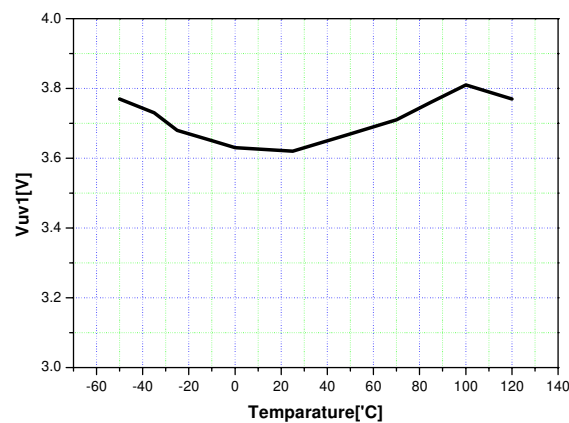

Figure 24. Output Voltage with UVLO Activated 1

Typical Characteristics (Continued)

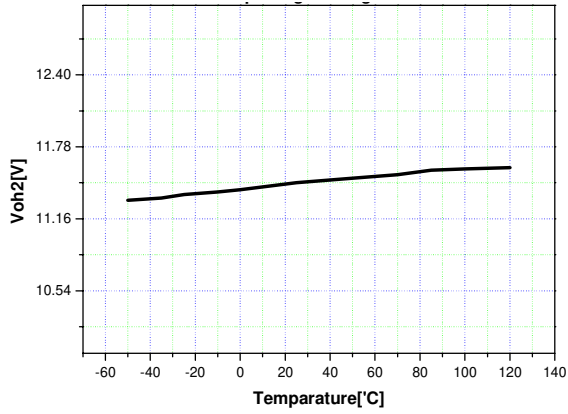

Figure 25. Output High Voltage 2

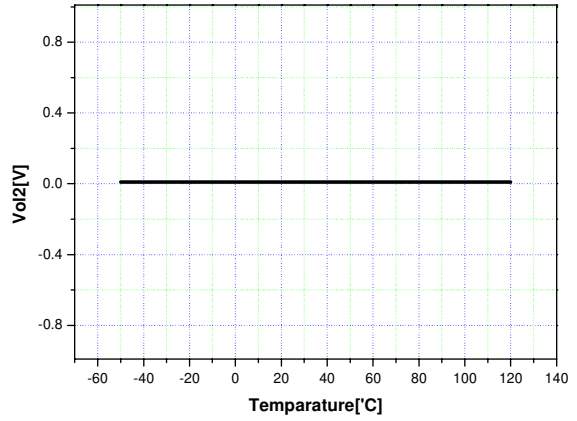

Figure 26. Output Low Voltage 2

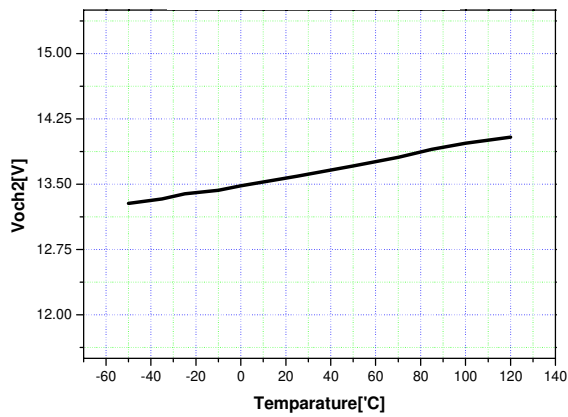

Figure 27. Output Clamping High Voltage 2

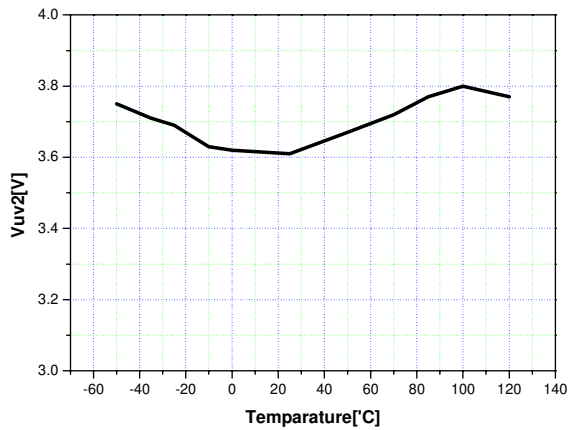

Figure 28. Output Voltage with UVLO Activated 1

Mechanical Dimensions

Package

Dimensions in millimeters

20-SSOP

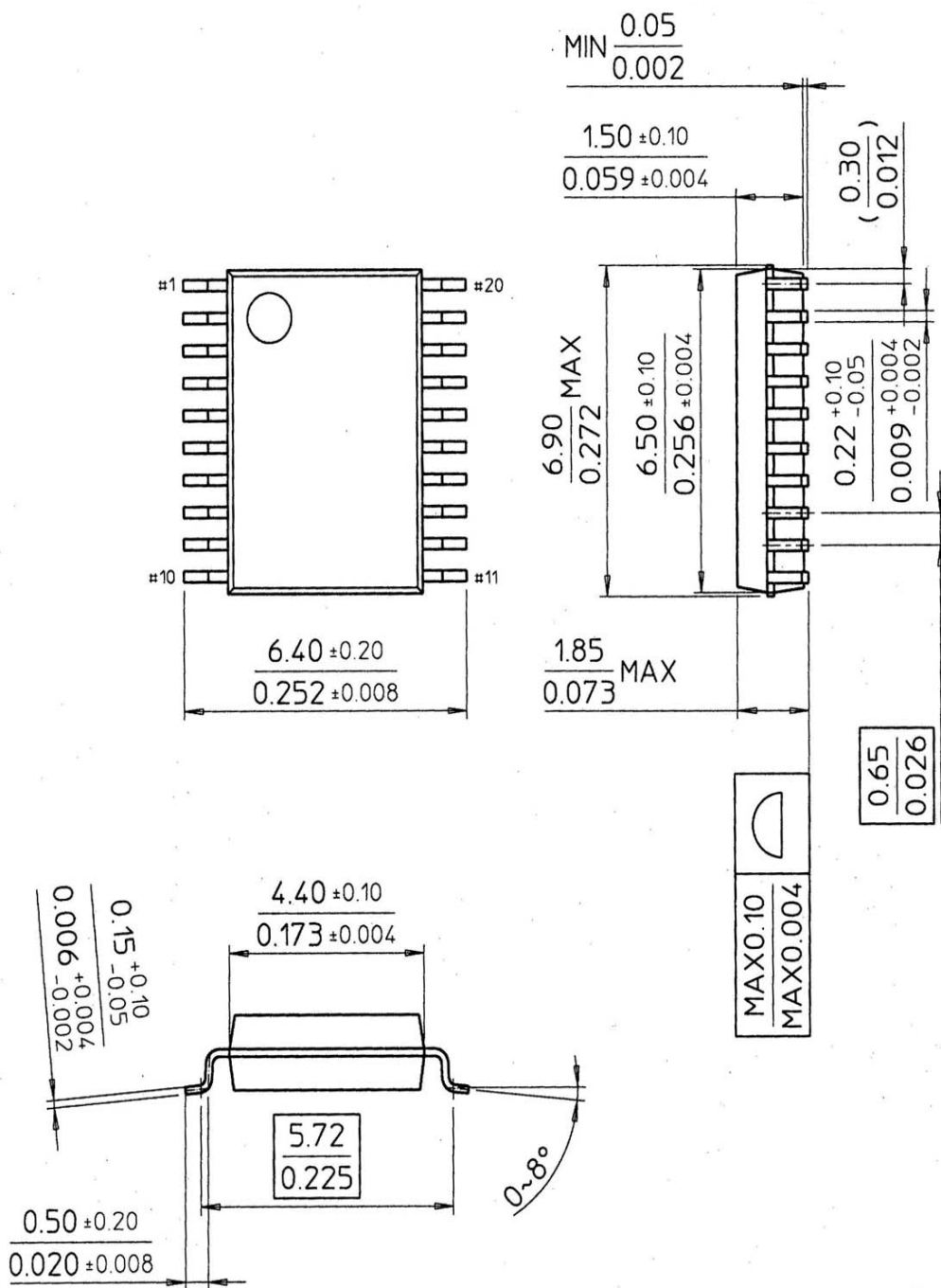

Ordering Information

Product number	Package	Operating Temperature
FAN7548G	20-SSOP	-25°C ~ 85°C

DISCLAIMER

FAIRCHILD SEMICONDUCTOR RESERVES THE RIGHT TO MAKE CHANGES WITHOUT FURTHER NOTICE TO ANY PRODUCTS HEREIN TO IMPROVE RELIABILITY, FUNCTION OR DESIGN. FAIRCHILD DOES NOT ASSUME ANY LIABILITY ARISING OUT OF THE APPLICATION OR USE OF ANY PRODUCT OR CIRCUIT DESCRIBED HEREIN; NEITHER DOES IT CONVEY ANY LICENSE UNDER ITS PATENT RIGHTS, NOR THE RIGHTS OF OTHERS.

LIFE SUPPORT POLICY

FAIRCHILD'S PRODUCTS ARE NOT AUTHORIZED FOR USE AS CRITICAL COMPONENTS IN LIFE SUPPORT DEVICES OR SYSTEMS WITHOUT THE EXPRESS WRITTEN APPROVAL OF THE PRESIDENT OF FAIRCHILD SEMICONDUCTOR CORPORATION. As used herein:

1. Life support devices or systems are devices or systems which, (a) are intended for surgical implant into the body, or (b) support or sustain life, and (c) whose failure to perform when properly used in accordance with instructions for use provided in the labeling, can be reasonably expected to result in a significant injury of the user.
2. A critical component in any component of a life support device or system whose failure to perform can be reasonably expected to cause the failure of the life support device or system, or to affect its safety or effectiveness.