

# Laser Material Processing

## Overview, Capabilities and Products

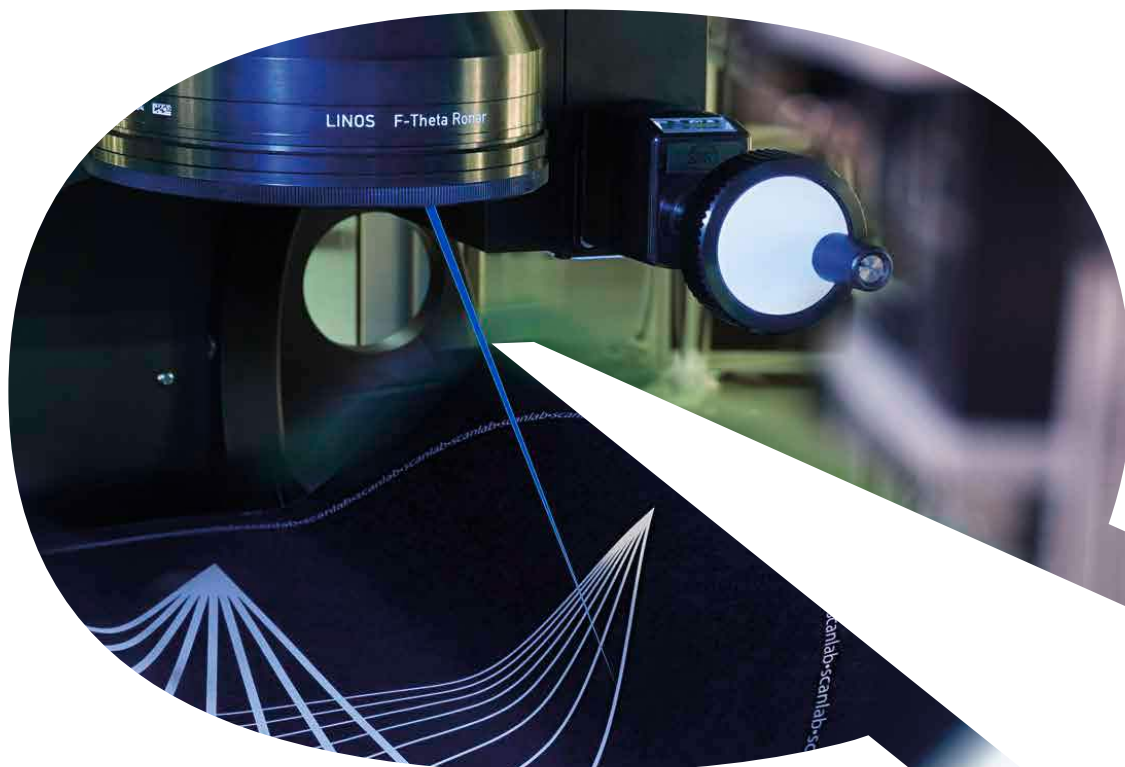

Qioptiq, an Excelitas Technologies Company, designs and manufactures photonic products and solutions that serve a wide range of applications across the medical, life sciences, industrial manufacturing, defense, semiconductor, aerospace, and scientific sectors.

Qioptiq customers benefit from the integrated knowledge and expertise of Avimo, Gsänger, LINOS, Optem, Point Source, Rodenstock, Spindler & Hoyer and others.

In October 2013, Qioptiq was acquired by Excelitas Technologies Corp., a global photonic technology leader focused on delivering innovative, customized solutions to meet the high-performance illumination, optical and, detection technology demands of OEM customers worldwide. Today, the Excelitas team proudly includes more than 7,000 employees across North America, Europe and Asia.

Visit [www.excelitas.com](http://www.excelitas.com) for more information.

1877



Rodenstock founded

1898



Spindler & Hoyer founded

1969



Gsänger Optoelektronik founded

1991



Point Source founded

1996



Linus is founded merging together Spindler & Hoyer, Steeg & Reuter, Franke Optik and Gsänger Optoelektronik. LINOS acquires Rodenstock Präzisionsoptik in 2000

2005



Qioptiq founded as a spin off from Thales High Tech Optics Group

2009



Qioptiq acquires Linos and Point Source establishing a new and consolidated brand

BIOMEDICAL



CONSUMER PRODUCTS



SEMICONDUCTOR

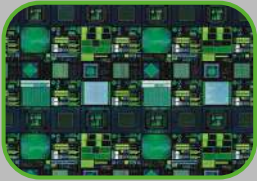

INDUSTRIAL



DEFENSE & AEROSPACE

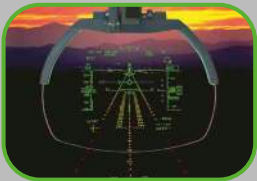

SCIENTIFIC & ANALYTICAL



# Content

Company Profile	02 – 03
Our Core Competencies	04 – 05

## General Information

Technical Explanations	06 – 07
Overview of F-Theta-Ronar Lenses	08 – 10
Overview of LINOS Beam Expanders	11 – 13

## LINOS F-Theta-Ronar Lenses

340-360 nm	14
440-460 nm	15
515-540 / 532 nm	16
940-980 nm	17
1030-1080 nm / 1064 nm	18
1900-2000 nm	19

## LINOS Beam Expanders

Manual Variable Versions	20
Motorized Versions	22

## Protective Glasses

24

## LINOS Focus-Ronar Lenses

355 nm	25
1064 + 532 nm	26

2010

2013

2018

2019

2021

## Products for Laser Material Processing

Benefit from over 40 years of experience in the development of optical systems for laser material processing!

Our broad selection of manual and motorized Beam Expanders and comprehensive range of LINOS F-Theta-Ronar and Focus-Ronar lenses are engineered to meet the most stringent requirements. We will serve you from development and prototyping to volume production. During the full lifetime of your product Qioptiq is your partner for your OEM needs.

## Our Core Competencies:

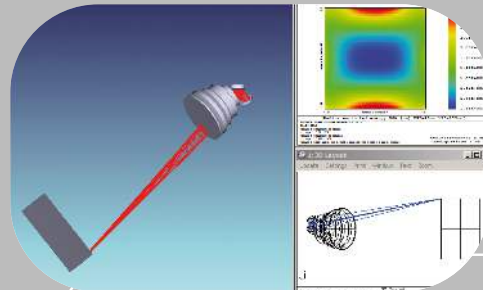

### Development

- Development of
  - Optical system design (in-house software-system, Code V<sup>®</sup>, Zemax<sup>®</sup>) including back reflection analysis
  - Mechanical design
  - Coating design
- FEM-analysis including thermal effects for high-power applications
- Advanced tolerance analysis and yield simulation adapted to Qioptiq patented mounting, adjustment and gluing technologies



# Consistent High-Quality Production from Rapid Prototype to High Volume



## Manufacturing

- State-of-the-art machinery for optics and mechanics production
- Development of in-house processes for precise assembly of optical elements
- Mounting techniques with accuracies down to 2  $\mu\text{m}$
- Active positioning and gluing technologies
- Cleanroom facilities
- Coating process from conventional deposition up to ion-beam-sputtering in spectral range: UV, VIS, NIR
- Low absorption coating for higher laser power applications

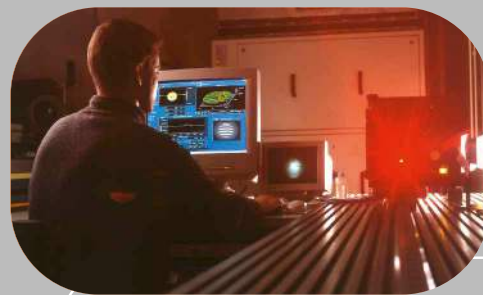

## Quality Control

- Automated measurement equipment for optical parameters (e.g. focal length)
- Measurements of the image spot diameter ( $1/e^2$ ) for Gaussian illumination for 355 nm, 532 nm and 1064 nm
- UV to NIR transmission measurements
- Absorption testing of the coatings at various wavelengths
- Environmental testing (temperature, humidity, vibration, shock)
- Quality report on request
- After sales service
- Technical support

# Technical Explanations

## Thermal focus shift

Thermal focus shift of beam guidance components is a topic especially for lasers of high beam quality and high power. When a light beam passes through an optical system, it loses a part of its energy. There is a local heating effect and thus a local deformation of the lens causing a change in the refractive index of the lens material. This results in a change in the propagation of the wave front of the laser beam in the medium and at the entrance and exit surfaces of the individual optical components. This phenomenon is referred to as a thermal lens and leads to a shift in the focus position, the so-called thermal focus shift, and deterioration of the beam quality.

It is a matter of design, material selection and production process that determine how well a lens can withstand environmental fluctuations and energy input by laser radiation. The most important strategy for reducing the thermal focus shift is to use materials that inherently absorb less energy. Qioptiq achieves this through using particularly selected, high-quality, fused-silica materials and a low-absorption coating of the lenses. In compliance with the specified maximum absorption of the coatings, they are monitored in batches using a specially developed absorption measuring device.

## Low Absorption

Low absorption is an essential property of our fused silica lenses and is achieved by a combination of various measures. It starts with the choice of high-grade materials, continues with the optimized coating process and followed up with optimized production and assembly processes under stringent cleanroom conditions.

## Low Outgassing

For upcoming UV applications with high laser powers or very short laser pulses, even higher requirements are needed. This is where cleanliness is most important. Even the smallest particles serve as a condensation core for the optics to self-destruct over the course of the operating time. This can only be prevented if the optical systems are manufactured in a special workflow. This includes avoidance of auxiliary materials, selection of materials such as a special stainless steel and high-grade materials, optimized coatings and assembly processes under cleanroom conditions through to ultra-low outgassing optical packages.

## Coating

Coatings are applied on each lens surface to maximize the transmission of the complete optical system like LINOS F-Theta-Ronar lenses or LINOS Beam Expanders. The additional challenge for coatings in laser material applications lies in a high damage resistance and minimized absorption.

The fused-silica optics in the wavelength range between 400 nm and 1080 nm are coated as standard with Qioptiq's newly developed "low absorption" coating, which has a specified absorption of  $\leq 20$  ppm at 1064 nm (typically better than 10 ppm) and  $\leq 30$  ppm at 532 nm (typically better than 15 ppm). The absorption is measured in batches with our own specially developed measuring device in series. Fused-silica lenses with this coating can be recognized by the product number ending -26.

Furthermore, the lenses of the motorized LINOS Beam Expanders for the wavelength ranges 515-540 nm and 1030-1080 nm are coated with the "low absorption" coating.

An excellent uniform transmission over the entire scan field is achieved with our special Qioptiq in-house developed angle-optimized coatings.

The respective damage threshold of the applied coating can be found in the datasheet of the corresponding lens.

All our coatings are analyzed for laser damage threshold values. The tests are conducted according to the standardized test method DIN EN ISO 11254-2, a multi-pulse procedure (S-on-1) with given pulse lengths.

7

# Overview of LINOS F-Theta-Ronar Lenses

## Applications for LINOS beam guidance components

The wide range of different laser sources and types opens up a broad market for focusing systems. Only with the provision of process-oriented focusing systems are the extremely diverse possible applications of the laser tool fully usable. LINOS F-Theta-Ronar lenses, LINOS Focus-Ronar lenses and LINOS Beam Expanders for laser material processing guarantee the best machining results over the entire working range. They contribute significantly to the optimization of process safety, especially in demanding tasks. The fields of application are extremely versatile:

- Additive manufacturing processes with metallic and organic substances (e.g. selective laser melting)
- Welding of metals and non-ferrous metals (e.g. battery cell manufacturing)
- Drilling and fineblanking of metals and ceramics (e.g. printed circuit board micro drillings)
- Plastic welding for the local melting of surfaces allows connections of plastics without additional materials
- Structuring/perforating of metallic and non-metallic materials (e.g. solar cells, display glass)
- Labelling (e.g. smart cards, ICs, printing plates, keyboards, controls with day & night design)
- Cleaning by means of laser pulses ensures a material-sparing treatment of industrial products (e.g. wafers) as well as restoration projects (e.g. monuments)
- (Consumer) electronics manufacturing
- Display manufacturing
- PCB production



## How the LINOS F-Theta-Ronar lenses work

A collimated laser beam is deflected, for example by galvanometer mirrors, at an angle  $\theta$  with respect to the optical axis. The LINOS F-Theta-Ronar lens focuses the ray bundles in its focal plane. By rotating the mirrors and thus changing the object angle  $\theta$ , the focal point moves over the working plane.

## Characteristics of F-Theta lenses

F-Theta lenses have two main characteristics. When a beam is deflected by a scanning mirror in front of a F-Theta lens, then the scanned distance is proportional to the scanning angle. Secondly the focus position over the entire scan field is always in the same plane.



## Basic calculations of F-Theta-Ronar lenses

All LINOS F-Theta-Ronar lenses achieve diffraction limited performance. The truncated entrance beam diameter and the image spot diameter refer to the intensity  $1/e^2$  at Gaussian illumination and for ideal  $M^2=1$ . The spot size of LINOS F-Theta-Ronar lenses can be calculated with the following formula:

$$\text{Spot-}\varnothing = 1.83 * \lambda * \text{FL} / \text{beam-}\varnothing$$

Spot- $\varnothing$ : image spot diameter [ $\mu\text{m}$ ]

1.83: factor of apodisation

$\lambda$ : wavelength [nm]

FL: focal length [mm]

Beam- $\varnothing$ : entrance-beam diameter [mm]

The scan length in each direction x or y can be calculated by the formula:

$$2y = \text{FL} * 2\Theta_y * \pi/180 \quad \text{and} \quad 2x = \text{FL} * 2\Theta_x * \pi/180$$

2x, 2y: scan length in direction x,y [mm]

FL: focal length [mm]

$2\Theta_{x,y}$ : max. scan angle Theta for each mirror [ $^\circ$ ]

$\pi/180$ : conversion factor (into radians)

The mirror distances m1 and m2 are recommended values and may vary. A smaller entrance beam diameter allows larger scan angles and therefore larger scan fields are achievable.

Application data

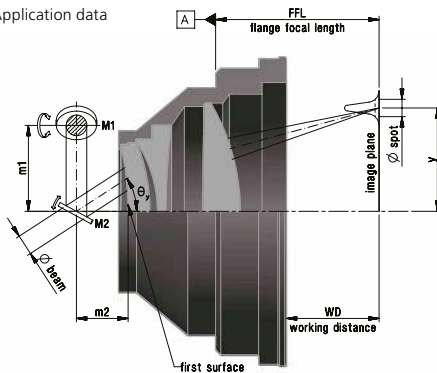

## Aperture

The aperture stop position of the system is characterized in that the chief ray of the incident beam bundle intersects the optical axis. When using only one scanning element, this is located at the aperture stop position.

It is desirable to position the scanning element as close as possible to the first lens element of the objective lens. Thus, the impact height of the beam on the first and all subsequent lenses and thus the lens diameters are minimized. The lens becomes more compact.

For systems with more than one scanning element (e.g. scan heads) the aperture stop position is different for the different scan angles. Since all lens aberrations, with the exception of the spherical aberration, depend on the aperture stop position, they vary depending on the mirror deflection. For this reason, the number of scanning elements, the distance to each other (m1), and to the lens (m2) must be known when the lens is being designed.

## Mirror distances

The design of the scan heads has a fundamental influence on the field size and the performance of the respective lens. Depending on the aperture and model, the distance between the two mirrors and thus the aperture stop position varies. In addition, the scan heads have different maximum deflection angles. These are usually limited by the scan head manufacturers to avoid overexposure of the mirror or a collision of both mirrors in excessive distraction. The distance between the mirrors is called m1.

The distance m2 is the distance between the vertex of the first lens surface and the center of the second scan head mirror.

## Product range of LINOS F-Theta-Ronar lenses

### Optical-glass lenses

For all major applications a wide variety of lenses exist with various focal lengths ranging from 100 mm to 420 mm and for different wavelengths from 532 nm to 1064 nm.

### Fused-silica lenses

Qioptiq has developed a range of sophisticated LINOS F-Theta-Ronar scan lenses made of fused-silica for high-power and short-pulse laser material processing. Fused-silica lenses provide minimized thermal focus shift and higher resistance when working at high power density. These lenses are usable for wavelength ranges of 340-360 nm, 440-460 nm, 515-540 nm, 1030-1080 nm or 1900-2000 nm. A specially developed coating achieves very low reflection and qualified absorption values. The optical designs minimize damage due to back reflections onto the scanning mirrors and internal reflections. The LINOS fused-silica F-Theta-Ronar lenses are suitable for fiber- and disk lasers.

### Telecentric lenses

With telecentric lenses the beam impact angle on the work target is nearly perpendicular over the entire scan field.

The maximum scan field of telecentric lenses cannot exceed the lens diameter. On the other hand the spot roundness and the impact angle is constant over the scan field.

This ensures that the point of impact of the beam bundle remains constant even with defocusing. Telecentricity is gaining great importance, for example, in drilling systems in the printed circuit board industry, some of which drill through millimeter thick circuit boards. In such extreme cases refocusing of the beam by beam widening is inevitable.

Qioptiq offers telecentric F-Theta-Ronar lenses made of fused-silica and of optical-glass/fused-silica combination.

### Customized solutions

In addition to our existing LINOS F-Theta-Ronar lenses Qioptiq offers customized solutions from adapted wavelength shift of standard lenses up to complete new designs. Please contact Qioptiq to discuss your requests with our specialists.

Application data

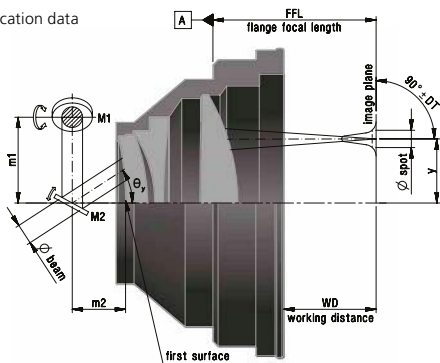

# Overview of LINOS Beam Expanders

LINOS Beam Expanders are optical systems for beam forming used in laser material processing. They can vary the diameter and the divergence of a laser beam and allow optimization of focus diameter, focus position and beam propagation.



The focal positions of LINOS F-Theta-Ronar or LINOS Focus-Ronar lenses can be changed by the divergence of the laser input beam. A fine focusing of the beam widening makes it possible to compensate for divergence tolerances of laser sources as well as focal length tolerances of other optical components. It should be noted, however, that the imaging performance of the lens may change.

- Laser structuring of foils
- Laser scribing of ceramic substrates
- Cutting of solar cells
- Micro drilling of sheet metal
- Marking of diverse materials with encodings
- (Consumer) electronics manufacturing
- Display manufacturing
- PCB production

11

Qioptiq offers standard versions of manual and motorized variable LINOS Beam Expanders made of fused-silica and/or optical-glass.

### Entrance aperture depending on the magnification factor

The maximum entrance aperture has to be considered. This depends on the magnification factor and decreases with increasing magnification factor. The permissible optical entrance aperture can be found in the datasheet of your respective Beam Expander.

LINOS Beam Expanders are optimally be applied in conjunction with LINOS F-Theta-Ronar lenses and LINOS Focus-Ronar lenses for applications including:

All LINOS Beam Expanders can also be implemented in reverse mode as Beam Reducers.

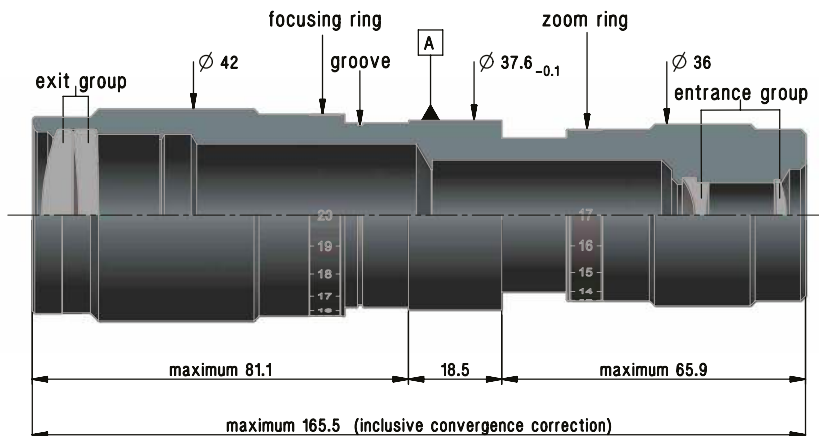

Variable Beam Expander

## Manual version

Continuous magnification between 1x ... 4x (low outgassing Beam Expander for 340-360 nm) and 2x ... 8x (Beam Expander for 355 nm, 532 nm, 633-980 nm, 1064 nm) are available. In addition Qioptiq offers manual variable LINOS Beam Expanders 2x ... 8x with fused-silica entrance lenses for higher laser power.

The back focal length of LINOS F-Theta-Ronar or LINOS Focus-Ronar lenses can be modified by changing the divergence of the incoming laser beam. Fine focusing of the Beam Expander compensates the focal length tolerances of other optical components as well as divergence of the laser source.

## Handling

Zoom and focusing rings of the manual variable LINOS Beam Expanders are set according to product specific graphs. The expansion factor is adjusted by turning the focusing ring and zoom ring. To focus the beam expansion, only the focusing ring should be adjusted.

The Beam Expander is mounted on surface A (previous page). Please take care that the laser beam is centered on the entrance lens and parallel to the optical axis of the Beam Expander (x; y; tilt adjustment).

## Maximum tilting of Beam Expanders

The LINOS Beam Expander can be operated with a max. entrance angle of up to 0.2° without vignetting. This allows a certain amount of leeway to compensate for mechanical tolerances in your system.

The tilting of the exiting laser beam is amplified by the inverse magnification factor with respect to the input beam. As a result, the laser beam does not pass through the lenses in the center of the lens, in particular on the exit side, so that the wavefront error becomes greater due to the asymmetry.

## Maximum displacement of the entrance beam

In case of lateral (x; y) displacement, the outer, non-central part of the laser beam is truncated. The wavefront is therefore no longer rotationally symmetric along the axis. In addition, a larger proportion of the input beam is vignettted, which results in a reduction of the transmitted energy. How much the wavefront deforms and the laser beam is vignettted depends on both the exact profile and the selected magnification.

### Motorized version

The motorized variable LINOS Beam Expanders are highly precise and easy to integrate. They are used in automatic production processes or in application laboratories. The controller is integrated into the Beam Expander.

For high-power or short-pulse laser applications full fused-silica designs are available with excellent transmission and thermal resistance performance. The special coating with low absorption and high transmission covers complete wavelength ranges of 340-360 nm, 515-540 nm or 1030-1080 nm. The customer can select between three electrical interfaces (SubD9/RS232, Phoenix Contact/RS232 or USB 2.0).



Motorized Beam Expander for 355 nm, 1x ... 4x



Motorized Beam Expander 2x ... 8x

### Software

The Windows™ -based software developed with LabView allows an easy control of the motorized LINOS Beam Expander. After initialization, the desired expansion is achieved by moving the two independent stepper motors. The lens positions for the magnification range of 1x ... 4x or 2x ... 8x are listed for each motorized Beam Expander type in provided tables. Ten individual presets can be stored.

The LINOS Beam Expander can also be directly controlled under other operating systems via the serial interface (e.g. terminal program). All serial interface commands are listed in the manual.

Further information including 3D CAD data, product-specific graphs of variable Beam Expanders and the manual for motorized Beam Expanders are available on request.

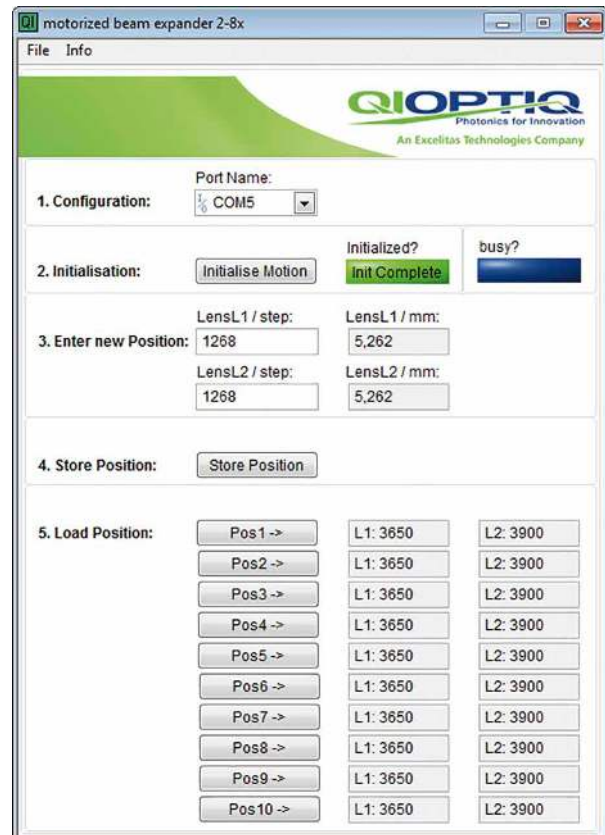

Windows™ software mask for easy control of motorized Beam Expanders.



# LINOS F-Theta-Ronar Lenses 340-360 nm



LINOS F-Theta-Ronar telecentric lens for 355 nm, focal length 167 mm

- Fused-silica designs
- Telecentric versions available
- Focal lengths ranging from 70 mm to 255 mm, tolerance  $\pm 1\%$
- Screw thread M85x1
- All lenses can be used with enlarged beam diameters and various mirror distances. Scan fields and spot size diameters will change accordingly. Please contact us to discuss your specific requirements.
- Transmission  $\geq 96\%$  with good performance in VIS-range
- Angle-optimized coatings
- Laser damage threshold coating up to  $4 \text{ J/cm}^2$  at 355 nm, 6 ns, 100 Hz
- Includes interchangeable fused-silica protective glasses
- Dust-tight on the output side inclusive protective glass according to the criteria of IP6X

14

## LINOS F-Theta-Ronar 340-360 nm, Fused-Silica

Nominal focal length (mm)	Scan field (mm <sup>2</sup> )	Max. scan angle $\pm\Theta_{x,y}$ (°)	Beam diameter truncated at $1/e^2$ (mm)	Spot diameter at $1/e^2$ ( $\mu\text{m}$ )	Mirror distances m1/m2 (mm)	Working distance (mm)	Protective glass	Part No.
70 telecentric	28 x 28	$\pm 11.3$	10	5	13/19	92.5	PG4	4401-576-000-21
100 telecentric	46 x 46	$\pm 12.7$	10	7	13/29	136.7	PG11	4401-509-000-21
160	98 x 98	$\pm 17.7$	7	15	9/16	197.4	PG4	4401-399-000-21
167 telecentric	65 x 65	$\pm 11.3$	10	13	13/48	255.0	PG15	4401-511-000-21
255	170 x 170	$\pm 19.3$	10	17	13/30	318.1	PG11	4401-481-000-21

## High quality

### Fused-silica lenses

Qioptiq has developed a range of sophisticated F-Theta-Ronar scan lenses made of specially selected fused-silica for high-power and short-pulse laser material processing. Fused-silica lenses provide minimized thermal focus shift and higher resistance when working at high power density. A specially developed coating achieves very low reflection and absorption values.

# LINOS F-Theta-Ronar Lens 440-460 nm



- Fused-silica designs
- Focal length 262 mm, tolerance  $\pm 1\%$ , further focal lengths coming soon
- Screw thread M85x1 and M110x1
- High end broadband, low absorption coating 440 - 460 nm
- Transmission  $\geq 96\%$
- Includes interchangeable fused-silica protective glasses
- Dust-tight on the output side inclusive protective glass according to the criteria of IP6X
- All lenses can be used with enlarged beam diameters and various mirror distances. Scan fields and spot size diameters will change accordingly. Please contact us to discuss your specific requirements.

## LINOS F-Theta-Ronar 440-460 nm, Fused-Silica, Low Absorption

Nominal focal length (mm)	Scan field (mm <sup>2</sup> )	Max. scan angle $\pm\Theta_{x,y}$ (°)	Beam diameter truncated at 1/e <sup>2</sup> (mm)	Spot diameter at 1/e <sup>2</sup> (µm)	Mirror distances m1/m2 (mm)	Working distance (mm)	Pro- tective glass	Part No.
262	61 x 61	$\pm 6.7$	30	8	37/35	342.6	PG30	4401-611-000-26

### A closer look



Please look at our Q-Shop for datasheets to our laser material lenses. The datasheets can be found at each product under Docs + Drawings.

Our Laser Material Processing brochure is also ready to download here.

The QR-Code guides you to the LINOS Laser Material Processing Section [https://www.qioptiq-shop.com/en/Precision-Optics/LINOS-Laseroptics-Lenses/?chosen\\_country=a7c40f631fc920687.20179984](https://www.qioptiq-shop.com/en/Precision-Optics/LINOS-Laseroptics-Lenses/?chosen_country=a7c40f631fc920687.20179984)

# LINOS F-Theta-Ronar Lenses

## 515-540/532 nm



LINOS F-Theta-Ronar telecentric lens for 515-540 nm, focal length 100 mm

- Fused-silica and optical-glass designs
- Telecentric versions available
- Focal lengths ranging from 100 mm to 420 mm, tolerance  $\pm 1\%$
- Screw thread M85x1 except 4401-605-000-26 M85x1/M110x1
- Transmission  $\geq 96\%$  with good performance in VIS-range
- Laser damage threshold coating for fused-silica lenses up to  $20 \text{ J/cm}^2$  at 532 nm, 8 ns, 100 Hz and up to  $0.6 \text{ J/cm}^2$  at 515 nm, 204 fs, 50 kHz
- Laser damage threshold coating for optical-glass lenses up to  $10 \text{ J/cm}^2$  at 532 nm, 6 ns, 100 Hz
- Low absorption coating for fused-silica lenses  $\leq 30 \text{ ppm}$  at 532 nm
- Includes interchangeable protective glasses
- Dust-tight on the output side inclusive protective glass according to the criteria of IP6X
- All lenses can be used with enlarged beam diameters and various mirror distances. Scan fields and spot size diameters will change accordingly. Please contact us to discuss your specific requirements.

16

### LINOS F-Theta-Ronar 515-540 nm, Fused-Silica, Low Absorption

Nominal focal length (mm)	Scan field (mm <sup>2</sup> )	Max. scan angle $\pm\Theta_{x,y}$ (°)	Beam diameter truncated at $1/e^2$ (mm)	Spot diameter at $1/e^2$ ( $\mu\text{m}$ )	Mirror distances m1/m2 (mm)	Working distance (mm)	Protective glass	Part No.
75 telecentric	24 x 24	$\pm 9.5$	14	5	17/24	85.8	PG28	4401-599-000-26
100 telecentric	43 x 43	$\pm 12.2$	14	9	17/28	138.5	PG13	4401-547-000-26
114 telecentric	65 x 65	$\pm 17.0$	10	11	13/28	144.5	PG13	4401-608-000-26
160	83 x 83	$\pm 15.2$	14	12	17/23	215.8	PG13	4401-587-000-26
167 telecentric	86 x 86	$\pm 15.4$	14	12	17/33	215.5	PG21	4401-517-000-26
250 telecentric	69 x 69	$\pm 8.0$	14	17	17/40	374.6	PG21	4401-616-000-26
255	183 x 183	$\pm 20.9$	10	25	13/25	318.1	PG13	4401-496-000-26
265	133 x 133	$\pm 14.7$	20	13	25/32	346.9	PG21	4401-605-000-26
420	251 x 251	$\pm 17.1$	14	29	17/24	498.6	PG13	4401-590-000-26

### LINOS F-Theta-Ronar 532 nm, Optical-Glass

Nominal focal length (mm)	Scan field (mm <sup>2</sup> )	Max. scan angle $\pm\Theta_{x,y}$ (°)	Beam diameter truncated at $1/e^2$ (mm)	Spot diameter at $1/e^2$ ( $\mu\text{m}$ )	Mirror distances m1/m2 (mm)	Working distance (mm)	Protective glass	Part No.
100	58 x 58	$\pm 17.7$	6	15	16/12	90.8	PG8	4401-304-000-21
100 telecentric	53 x 53	$\pm 15.7$	14	7	17/36	126.6	PG7	4401-461-000-21
160	98 x 98	$\pm 17.7$	10	16	16/12	176.1	PG8	4401-305-000-21
250	154 x 154	$\pm 17.7$	20	12	22/24	288.5	PG7	4401-289-000-20
330	204 x 204	$\pm 17.7$	14	23	18/24	389.0	PG7	4401-485-000-21
420	275 x 275	$\pm 18.7$	15	27	17/28	494.6	PG7	4401-489-000-21

# LINOS F-Theta-Ronar Lenses 940-980 nm



- Focal lengths ranging from 100 mm to 420 mm, tolerance  $\pm 1\%$
- Screw thread M85x1, except 4401-527-000-21 M76x1
- Transmission  $\geq 97\%$
- Transmission  $\geq 75\%$  at VIS-range
- Includes interchangeable protective glasses
- All lenses can be used with enlarged beam diameters and various mirror distances. Scan fields and spot size diameters will change accordingly. Please contact us to discuss your specific requirements.

LINOS F-Theta-Ronar lens for 940-980 nm, focal length 330 mm

## LINOS F-Theta-Ronar 940-980 nm, Optical-Glass

Nominal focal length (mm)	Scan field (mm <sup>2</sup> )	Max. scan angle $\pm\theta_{x,y}$ (°)	Beam diameter truncated at $1/e^2$ (mm)	Spot diameter at $1/e^2$ (μm)	Mirror distances m1/m2 (mm)	Working distance (mm)	Pro-protective glass	Part No.
100	42 x 42	$\pm 12.1$	14	14	17/18	96.9	PG19	4401-528-000-21
162	84 x 84	$\pm 14.8$	14	20	17/33	183.7	PG18	4401-527-000-21
254	120 x 120	$\pm 13.6$	20	23	26/28	294.2	PG17	4401-526-000-21
330	202 x 202	$\pm 17.6$	20	30	26/28	386.0	PG17	4401-524-000-21
420	253 x 253	$\pm 17.3$	20	37	26/28	491.7	PG17	4401-525-000-21

# LINOS F-Theta-Ronar Lenses 1030-1080 nm / 1064 nm



LINOS F-Theta-Ronar lens for 1030-1080 nm, focal length 420 mm

- Fused-silica and optical-glass designs
- Telecentric versions available
- Focal lengths ranging from 70 mm to 420 mm, tolerance  $\pm 1\%$
- Screw thread M85x1, except 4401-261-000-21 M76x1 and 4401-604-000-26 M85x1/M110x1
- Low absorption coating for fused-silica lenses  $\leq 20$  ppm at 1064 nm
- Includes interchangeable protective glasses
- Dust-tight on the output side inclusive protective glass according to the criteria of IP6X
- Transmission  $\geq 96\%$  with good performance in VIS-range
- Laser damage threshold coating for fused-silica lenses up to  $40 \text{ J/cm}^2$  at 1064 nm, 12 ns, 100 Hz and up to  $0.9 \text{ J/cm}^2$  at 1030 nm, 291 fs, 5 kHz
- Laser damage threshold coating for optical-glass lenses up to  $10 \text{ J/cm}^2$  at 1064 nm, 9 ns, 100 Hz
- All lenses can be used with enlarged beam diameters and various mirror distances. Scan fields and spot size diameters will change accordingly. Please contact us to discuss your specific requirements.

18

## LINOS F-Theta-Ronar 1030-1080 nm, Fused-Silica, Low Absorption

Nominal focal length (mm)	Scan field (mm <sup>2</sup> )	Max. scan angle $\pm\Theta_{x,y}$ (°)	Beam diameter truncated at $1/e^2$ (mm)	Spot diameter at $1/e^2$ ( $\mu\text{m}$ )	Mirror distances m1/m2 (mm)	Working distance (mm)	Protective glass	Part No.
70 telecentric	26 x 26	$\pm 10.9$	14	10	17/17	87.5	PG22	4401-551-000-26
100 telecentric	44 x 44	$\pm 12.2$	14	15	17/28	137.0	PG14	4401-561-000-26
118 telecentric	50 x 50	$\pm 15.5$	14	17	17/28	233.9	PG14	4401-607-000-26
163	85 x 85	$\pm 15.2$	14	23	17/23	219.3	PG14	4401-589-000-26
167 telecentric	84 x 84	$\pm 14.9$	20	16	26/28	215.4	PG16	4401-513-000-26
251 telecentric	63 x 63	$\pm 14.4$	20	25	25/30	372.3	PG16	4401-631-000-26
255	187 x 187	$\pm 21.3$	10	50	13/25	317.4	PG14	4401-499-000-26
270	136 x 136	$\pm 14.8$	20	27	25/32	352.0	PG16	4401-604-000-26
340	176 x 176	$\pm 15.1$	20	33	26/26	441.6	PG16	4401-546-000-26
420	254 x 254	$\pm 17.3$	20	42	26/24	510.9	PG14	4401-508-000-26

## LINOS F-Theta-Ronar 1064 nm, Optical-Glass

Nominal focal length (mm)	Scan field (mm <sup>2</sup> )	Max. scan angle $\pm\Theta_{x,y}$ (°)	Beam diameter truncated at $1/e^2$ (mm)	Spot diameter at $1/e^2$ ( $\mu\text{m}$ )	Mirror distances m1/m2 (mm)	Working distance (mm)	Protective glass	Part No.
100	62 x 62	$\pm 17.7$	12	16	16/12	97.7	PG2	4401-302-000-21
100 telecentric*	57 x 57	$\pm 17.0$	14	14	17/29	126.0	PG6	4401-464-000-21
160	99 x 99	$\pm 17.7$	12	26	16/12	176.2	PG2	4401-301-000-21
163	115 x 115	$\pm 20.2$	10	32	13/24	185.9	PG5	4401-261-000-21
254	157 x 157	$\pm 17.7$	20	25	26/23	296.2	PG6	4401-288-000-20
330	217 x 217	$\pm 18.7$	16	40	18/24	387.6	PG6	4401-360-000-21
420	291 x 291	$\pm 19.8$	15	55	30/16	494.2	PG6	4401-350-000-21

\* Entrance lens made of fused-silica



# LINOS F-Theta-Ronar Lenses 1900-2000 nm



LINOS F-Theta-Ronar lens for 1900-2000 nm, focal length 265 mm

- Fused-silica designs
- Focal lengths ranging from 265 mm to 437 mm, tolerance  $\pm 1\%$
- Screw thread M85x1
- All lenses can be used with enlarged beam diameters and various mirror distances. Scan fields and spot size diameters will change accordingly. Please contact us to discuss your specific requirements.
- Transmission  $\geq 95\%$  at 1940 nm
- Includes interchangeable protective glasses
- Dust-tight on the output side inclusive protective glass according to the criteria of IP6X

## LINOS F-Theta-Ronar 1900-2000 nm, Fused-Silica

Nominal focal length at 1940 nm (mm)	Scan field (mm <sup>2</sup> )	Max. scan angle $\pm\Theta_{x,y}$ (°)	Beam diameter truncated at $1/e^2$ (mm)	Spot diameter at $1/e^2$ (μm)	Mirror distances m1/m2 (mm)	Working distance (mm)	Protective glass	Part No.
265	155 x 155	$\pm 16.9$	14	68	17/34	328.0	PG23	4401-588-000-21
354	214 x 214	$\pm 16.6$	14	90	17/28.5	457.5	PG24	4401-569-000-21
437	292 x 292	$\pm 19.2$	14	100	17/29.5	526.2	PG23	4401-568-000-21

## A closer look



Please look at our Q-Shop for datasheets to our laser material lenses. The datasheets can be found at each product under Docs + Drawings.

Our Laser Material Processing brochure is also ready to download here.

The QR-Code guides you to the LINOS Laser Material Processing Section [https://www.gioptiq-shop.com/en/Precision-Optics/LINOS-Laseroptics-Lenses/?chosen\\_country=a7c40f631fc920687.20179984](https://www.gioptiq-shop.com/en/Precision-Optics/LINOS-Laseroptics-Lenses/?chosen_country=a7c40f631fc920687.20179984)



# LINOS Low Outgassing Manual Variable Beam Expander



- Continuous variation of magnification 1x...4x and exit-beam divergence
- Fused-silica design
- Optimized design for 355 nm wavelength
- High end broadband coating 340-360 nm for high power and short pulses
- Transmission T (340 - 360 nm)  $\geq 96\%$  and  $> 90\%$  @ 635 nm
- Laser damage threshold coating for fused-silica lenses up to 4 J/cm<sup>2</sup> at 355 nm, 6 ns, 100Hz
- Includes interchangeable and coated fused-silica protective glasses
- Max. entrance beam diameter:
  - up to 10 mm for the intensity 1/e<sup>2</sup>
  - up to 12 mm (truncated)
- Max. exit-beam diameter up to 24 mm (truncated)
- Precise scales allow reliable and intuitive settings with high repeatability
- Pointing stability  $< 0.2$  mrad
- Different mechanical interfaces: M30x1 (entrance side), M46x0.5 (exit side),  $\varnothing 62$ h9

20

## LINOS Manual Variable Beam Expander 1x ... 4x, Fused-Silica, Low Outgassing

Wavelength (nm)	Expansion factor	Max. entrance-beam diameter at 1/e <sup>2</sup> / truncated (mm)	Part No.
340-360	1x - 2x	10.0 / 12.0	4401-613-000-28
	2x - 2.5x	8.0 / 9.6	
	2.5x - 3.0x	6.5 / 7.8	
	3x - 4x	5.0 / 6.0	

# LINOS Manual Variable Beam Expanders



LINOS Beam Expander with a variable expansion factor 2x to 8x for 1064 nm

- Continuous variation of magnification 2x...8x
- Choice between fused-silica or glass entrance lens
- Continuous variation of exit-beam divergence
- Wavelengths 355 nm, 532 nm, 633/780/830/980 nm or 1064 nm
- Precise scales allow reliable settings and high repeatability
- Max. exit-beam diameter 31 mm
- Max. length 165.5 mm
- Max. diameter 42.0 mm
- Mounting diameter 37.6<sub>-0.1</sub> mm, reference on surface A (see page 15)

## Laser damage threshold coating up to:

	Laser damage threshold (J/cm <sup>2</sup> )	Pulse length (ns)
355 nm Fused-silica	5	5
532 nm Optical-glass	10	6
532 nm Entrance lens fused-silica	20	6
633/780/830/980 nm Optical-glass	6	6
1064 nm Optical-glass	20	9
1064 nm Entrance lens fused-silica	30	9

## LINOS Manual Variable Beam Expander 2x...8x

Wavelength (nm)	Max. entrance-beam diameter truncated at 1/e <sup>2</sup> (mm)	Material	Part No.
355	3.4	Fused-silica	4401-402-000-20
532	4	Fused-silica + Optical-glass	4401-446-000-20
532	8	Optical-glass	4401-257-000-20
633/780/ 830/980	8	Optical-glass	4401-258-000-20
1064	4	Fused-silica + Optical-glass	4401-359-000-20
1064	8	Optical-glass	4401-256-000-20

Entrance beam diameter max. = 31 mm / zoom factor.

# LINOS Motorized Beam Expanders



Motorized Beam Expander for 355 nm, 1x ... 4x

- Continuous variable magnification 1x...4x and 2x...8x
- Fused-silica designs
- Continuous variation of exit-beam divergence
- Wavelengths 340-360 nm, 515-540 nm or 1030-1080 nm
- Software running on Windows™ platform
- Reduce machine setup times by automatic change of magnification
- Maintains laser-protection class during readjustment of the Beam Expander
- All-in-one design, controller integrated
- CE and ROHS conform
- IP 20
- Laser damage threshold coating up to 4 J/cm<sup>2</sup> at 355 nm, 6 ns, 100 Hz
- Laser damage threshold coating up to 20 J/cm<sup>2</sup> at 532 nm, 8 ns, 100 Hz and 0.6 J/cm<sup>2</sup> at 515 nm, 204 fs, 50 kHz
- Laser damage threshold coating up to 40 J/cm<sup>2</sup> at 1064 nm, 12 ns, 100 Hz and 0.9 J/cm<sup>2</sup> at 1030 nm, 291 fs, 5 kHz
- Includes interchangeable protective glasses
- Max. exit beam diameter 31 mm
- 10 individual presets for magnification and divergence
- Pointing stability < 0.5 mrad
- Adjustment from 2x to 8x about 7 sec
- Mechanical dimensions: length 167 mm (1x...4x), 203 mm (2x...8x), width 58 mm, height 55.5 mm
- Mechanical interface via high-precision holes 6<sup>H7</sup> (recommended) or mounting diameter 39<sub>h11</sub>
- Different electronic interfaces: SubD9/RS232, USB 2.0, Phoenix Contact/RS232
- Baud rate: 9600 bit/sec
- Power input 7–12 V, Phoenix Contact 7-24 V

Part No. suffix for PC interface	
SubD9/ RS232	-20
Phoenix Contact/ RS232	-21
USB 2.0	-22

22

## LINOS Motorized Beam Expander 1x ... 4x, Fused-Silica

Wavelength (nm)	Max. entrance beam diameter truncated at 1/e <sup>2</sup> (mm)	Low absorption	Part No.
340 - 360	8		4401-596-000-20
340 - 360	8		4401-596-000-21
340 - 360	8		4401-596-000-22
515 - 540	8	✓	4401-597-000-20
515 - 540	8	✓	4401-597-000-21
515 - 540	8	✓	4401-597-000-22
1030 - 1080	8	✓	4401-598-000-20
1030 - 1080	8	✓	4401-598-000-21
1030 - 1080	8	✓	4401-598-000-22

Entrance beam diameter max. = 31 mm / zoom factor.



Motorized Beam Expander 2x ... 8x

Part No. suffix for PC interface	
SubD9/ RS232	-20
Phoenix Contact/ RS232	-21
USB 2.0	-22

## LINOS Motorized Beam Expander 2x ... 8x, Fused-Silica

Wavelength (nm)	Max. entrance beam diameter truncated at 1/e <sup>2</sup> (mm)	Low absorption	Part No.
340 - 360	6		4401-516-000-20
340 - 360	6		4401-516-000-21
340 - 360	6		4401-516-000-22
515 - 540	8	✓	4401-515-000-20
515 - 540	8	✓	4401-515-000-21
515 - 540	8	✓	4401-515-000-22
1030 - 1080	8	✓	4401-514-000-20
1030 - 1080	8	✓	4401-514-000-21
1030 - 1080	8	✓	4401-514-000-22

Entrance beam diameter max. = 31 mm / zoom factor.



# Protective Glasses



- Optimum protection for diverse optical systems
- Coated on both sides
- High transmission for the corresponding wavelength or wavelength range
- High laser damage threshold
- Short delivery time

24

## Protective Glasses, Fused-Silica

Protective glass	Protective glass diameter (mm)	Protective glass thickness (mm)	AR coated for $\lambda$ (nm)	Part No.
PG 4	75	1.5	340-380+633	4401-399-005-00
PG11	113	3	340-380+633	4401-481-005-00
PG13	113	3	515-540, low absorption	4401-496-005-01
PG14	113	3	1030-1080, low absorption	4401-499-005-00
PG15	113	3	340-380+633	4401-511-823-00
PG16	132	3	1030-1080, low absorption	4401-513-006-00
PG21	132	3	515-540, low absorption	4401-517-006-00
PG22	75	1.5	1030-1080, low absorption	4401-551-016-00
PG23	113	3	1900-2000	4401-568-004-00
PG24	132	3	1900-2000	4401-569-005-00
PG25	17.5	1.6	1030-1080, low absorption	4401-514-006-00
PG26	17.5	1.6	515-540, low absorption	4401-515-006-00
PG27	17.5	1.6	340-380+633	4401-516-006-00
PG28	75	1.5	515-540, low absorption	4401-599-006-00
PG30	132	3	440-460, low absorption	4401-611-006-00
PG31	35	1.5	340-380+633	4401-613-008-00

## Protective Glasses, Optical-Glass

Protective glass	Protective glass diameter (mm)	Protective glass thickness (mm)	AR coated for $\lambda$ (nm)	Part No.
PG 2	75	1.6	1064+VIS	4401-301-001-00
PG 5	100	3	1064+VIS	4401-261-004-00
PG 6	113	3	1064+VIS	4401-288-005-01
PG 7	113	3	532	4401-289-007-00
PG 8	75	1.6	532	4401-304-005-00
PG17	113	3	940-980	4401-524-004-00
PG18	100	3	940-980	4401-527-004-00
PG19	75	1.6	940-980	4401-528-005-00

# LINOS Focus-Ronar Lenses for 355 nm



Focusing lenses are optimized for high precision applications, as used in laser systems for welding, cutting, drilling and structuring.

- Focal lengths ranging from 58 mm to 120 mm
- Flexible lens exchange without any adjustment
- Three-lens-element designs
- Full fused-silica designs
- Diffraction limited up to 17.5 mm ( $1/e^2$ ) entrance-beam diameter
- High clear aperture up to 35.5 mm
- Housing diameter 41 mm
- Transmission  $\geq 98\%$
- Damage threshold 5 J/cm<sup>2</sup> with pulse duration of 5 ns, 100 Hz

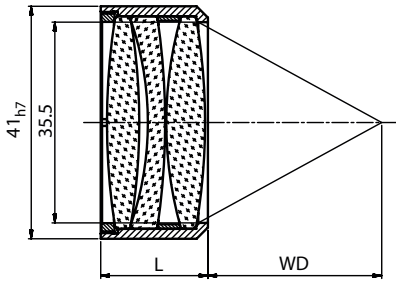

## LINOS Focus-Ronar 355 nm, Fused-Silica

Focal length (mm)	Length L (mm)	Working distance WD (mm)	Part No.
58	26.7	48.9	4401-519-000-20
77	25.1	68.8	4401-521-000-20
90	25.1	81.7	4401-522-000-20
120	24.7	112.0	4401-523-000-20

# LINOS Focus-Ronar Lenses 1064 nm + 532 nm



Focusing lenses are optimized for high precision applications, as used in laser systems for welding, cutting, drilling and structuring.

- Focal lengths ranging from 58 mm to 122 mm
- Flexible lens exchange without any adjustment
- Three-lens-element designs
- High clear aperture up to 35 mm
- Housing diameter 41<sub>h7</sub> mm
- The coating is optimized for 1064 nm, T ≥ 97% and T(532 nm) ≥ 96%
- Good inspection performance at VIS wavelengths
- Laser damage threshold coating 10 J/cm<sup>2</sup> at 1064 nm, 9 ns, 100 Hz
- Laser damage threshold 6 J/cm<sup>2</sup> at 532 nm, 6 ns, 100 Hz

26

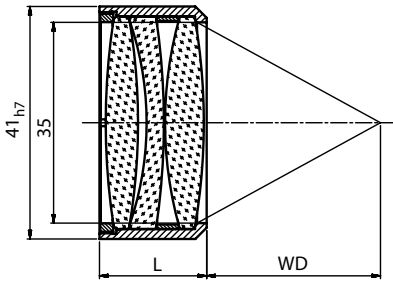

## LINOS Focus-Ronar 1064 + 532 nm, Optical-Glass

Focal length at 1064 nm (mm)	Length L (mm)	Working distance for 1064 nm (mm)	Working distance for 532 nm (mm)	Part No.
58	24.6	48.3	47.8	4401-505-000-20
77	18.9	72.2	71.6	4401-486-000-20
90	33.6	73.7	73.1	4401-490-000-20
122	24.0	111.5	111.6	4401-420-000-21

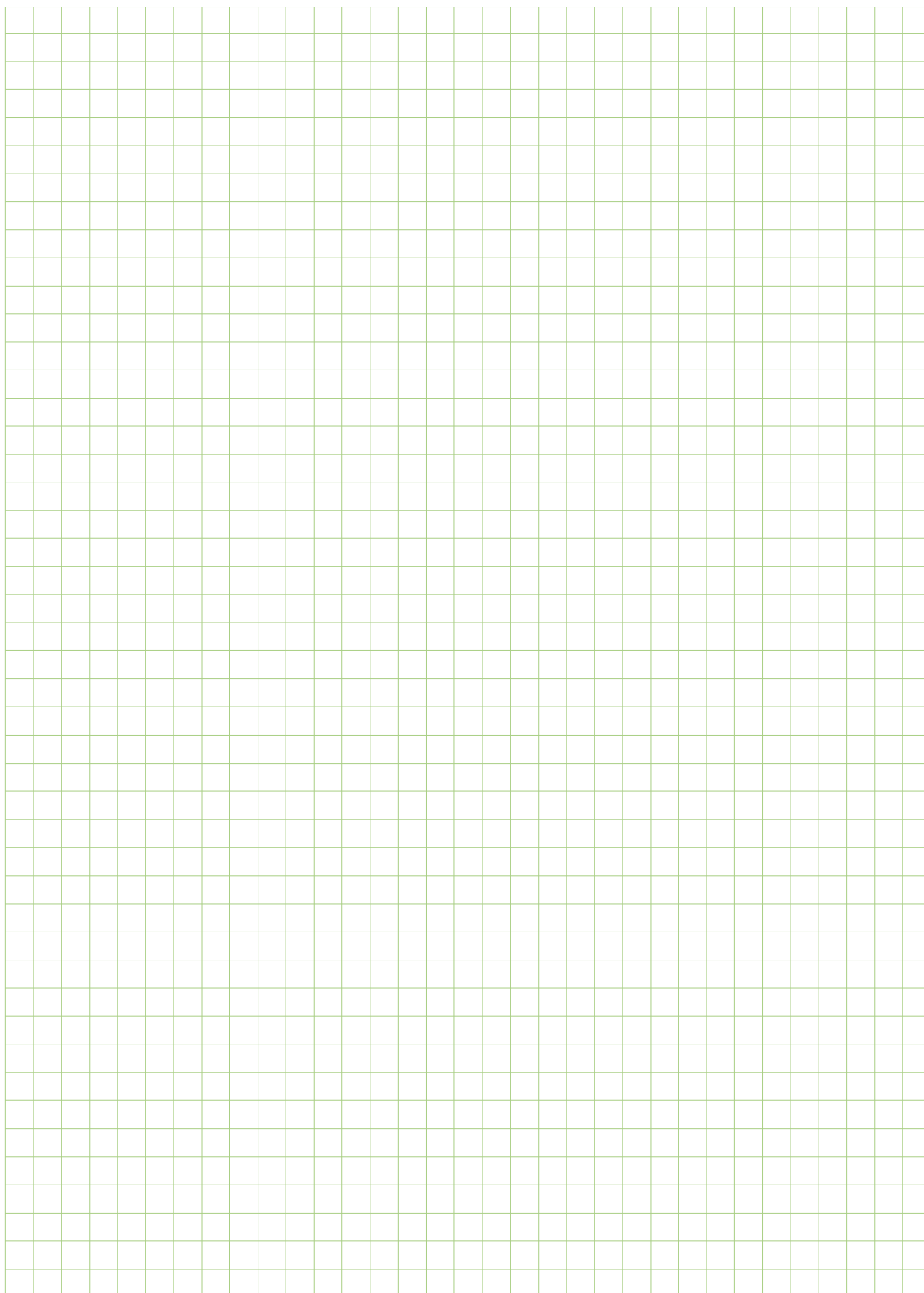



Qioptiq provides and enables cutting-edge photonics technology across a wide range of applications within industrial manufacturing. Our expanding global footprint, growing range of optical technologies and state-of-the-art manufacturing capabilities ensure exacting solutions with timely delivery and regional access and support.

**Enabling the future through light.**



**[www.excelitas.com](http://www.excelitas.com)**

**Europe**  
+49 (0) 551 6935-0

**North America**  
+1 (800) 429 0257

**Asia/Pacific**  
+65 64 99 7777