

### ANGELINA-M-B

~30° medium beam compatible with BJB and B+W connectors

#### SPECIFICATION:

Dimensions	Ø 82.0 mm
Height	31 mm
Fastening	socket
ROHS compliant	yes ⓘ

#### MATERIALS:

Component	Type	Material	Colour	Finish	Coating
ANGELINA-M-B	Reflector	PC	metal		HMDS

#### ORDERING INFORMATION:



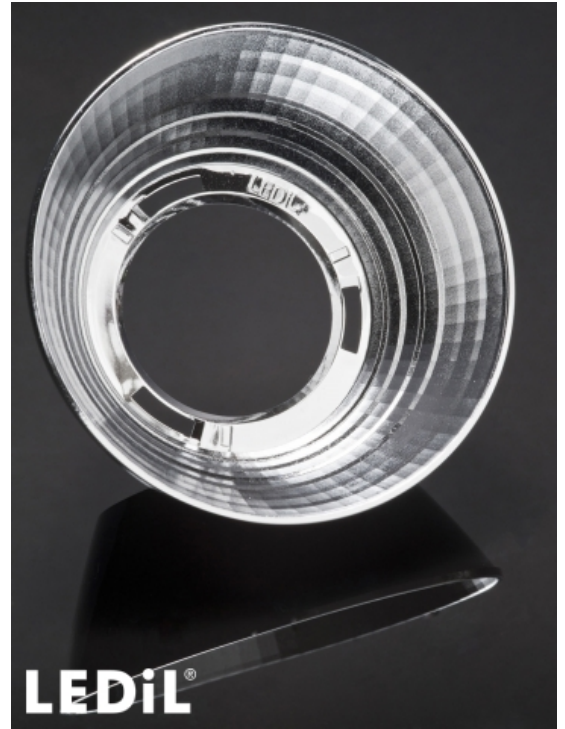

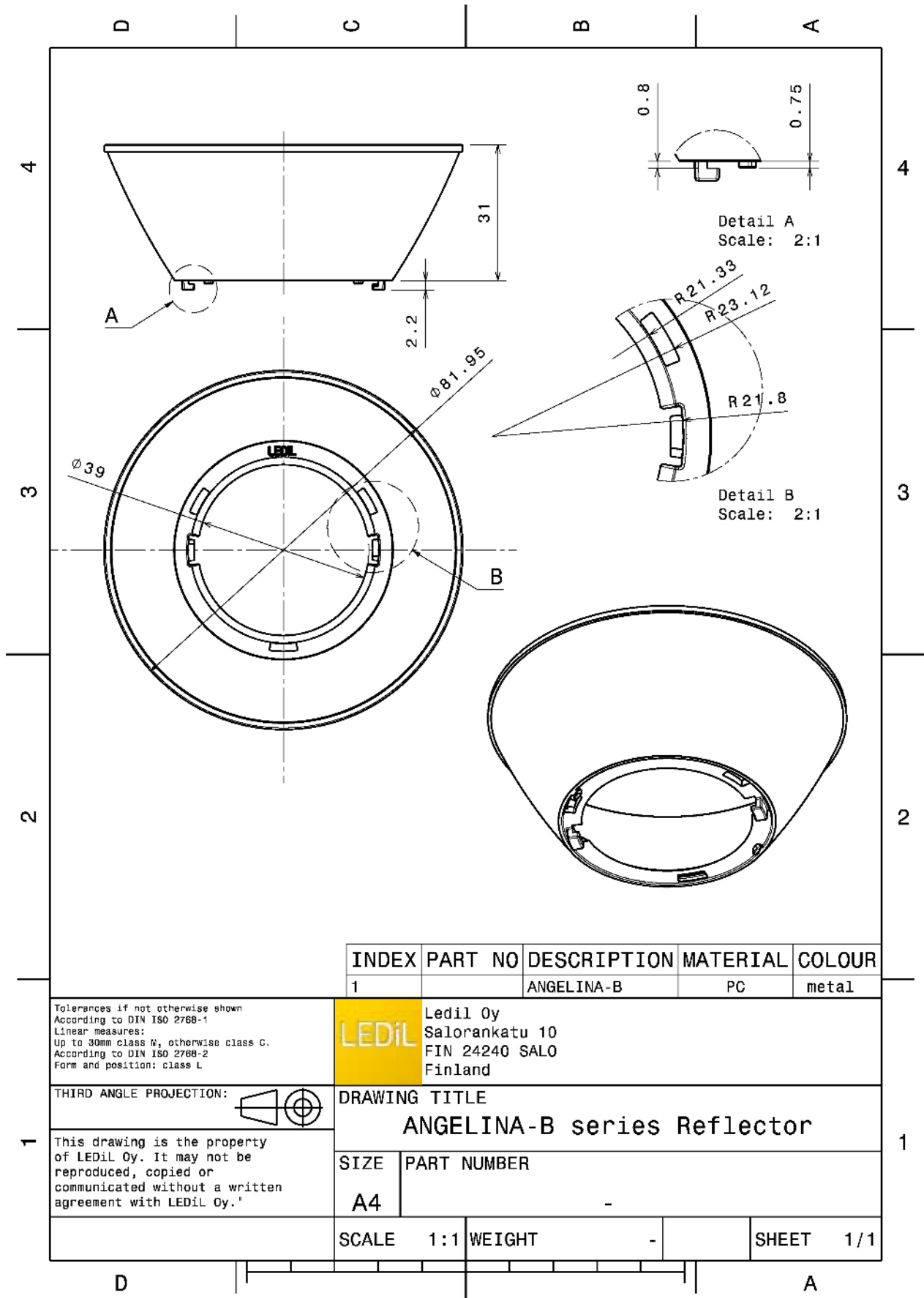

Component	Qty in box	MOQ	MPQ	Box weight (kg)
F13660_ANGELINA-M-B » Box size: 480 x 280 x 300 mm	825	110	55	10.0



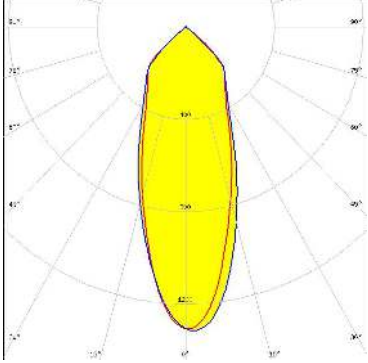

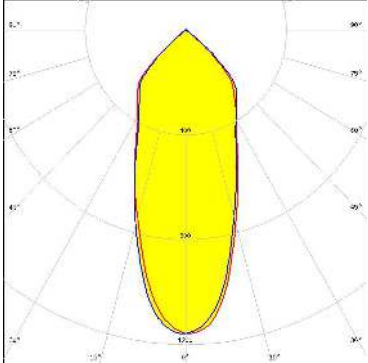

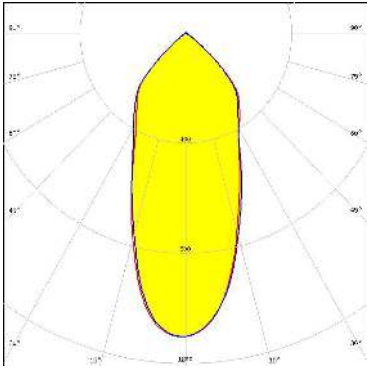

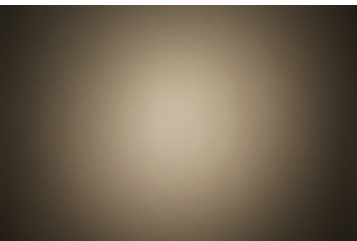
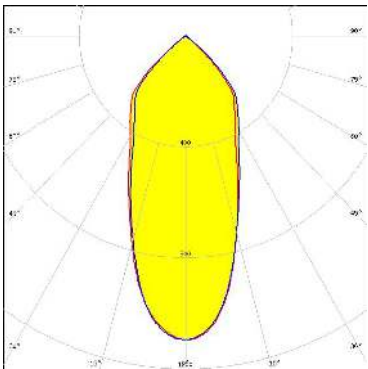
See also our general installation guide: [www.ledil.com/installation\\_guide](http://www.ledil.com/installation_guide)

#### OPTICAL RESULTS (MEASURED):

<p></p> <p>LED BXRA ES Rectangle</p> <p>FWHM / FWTM 38.0° / 97.0°</p> <p>Efficiency 92 %</p> <p>Peak intensity 1.3 cd/lm</p> <p>LEDs/each optic 1</p> <p>Light colour White</p> <p>Required components: BJB: 47.319.2040</p>		
<p></p> <p>LED V15 Gen6</p> <p>FWHM / FWTM 41.0° / 98.0°</p> <p>Efficiency 93 %</p> <p>Peak intensity 1.2 cd/lm</p> <p>LEDs/each optic 1</p> <p>Light colour White</p> <p>Required components: BJB: 47.319.2224</p>		
<p></p> <p>LED V18 Gen6</p> <p>FWHM / FWTM 44.0° / 98.0°</p> <p>Efficiency 93 %</p> <p>Peak intensity 1.1 cd/lm</p> <p>LEDs/each optic 1</p> <p>Light colour White</p> <p>Required components: BJB: 47.319.2274</p>		
<p></p> <p>LED V18 Gen7</p> <p>FWHM / FWTM 44.0° / 99.0°</p> <p>Efficiency 93 %</p> <p>Peak intensity 1.1 cd/lm</p> <p>LEDs/each optic 1</p> <p>Light colour White</p> <p>Required components: BJB: 47.319.2350</p>		

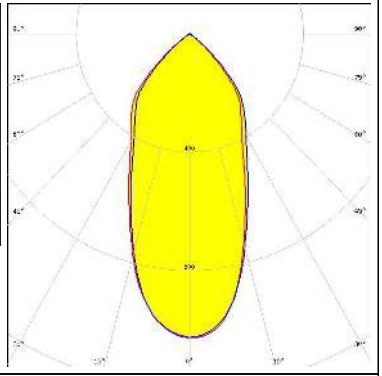
#### OPTICAL RESULTS (MEASURED):

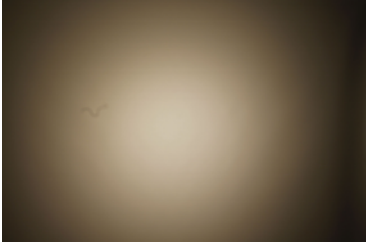
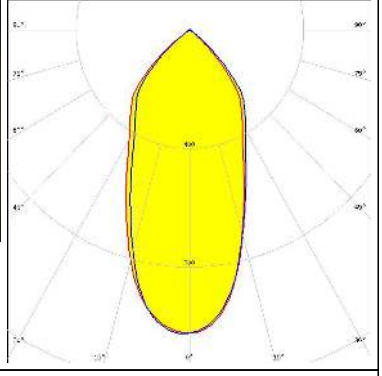
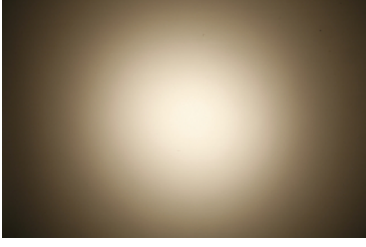
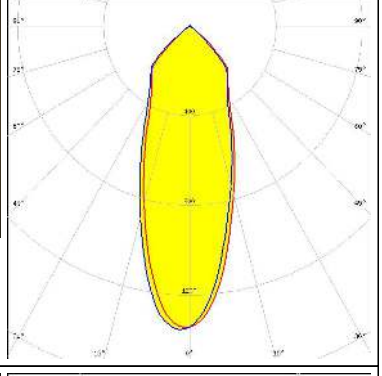
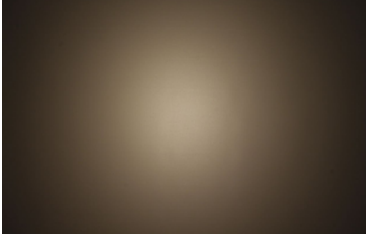
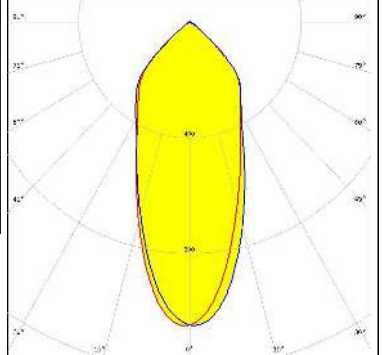
<p></p> <p>LED V22 Gen6            FWHM / FWTM 47.0° / 98.0°            Efficiency 91 %            Peak intensity 1 cd/lm            LEDs/each optic 1            Light colour White            Required components:            A.A.G. STUCCHI: 8102-G2</p>		
<p></p> <p>LED V22 Gen7            FWHM / FWTM 47.0° / 98.0°            Efficiency 91 %            Peak intensity 1 cd/lm            LEDs/each optic 1            Light colour White            Required components:            BJB: 47.319.2030</p>		
<p><b>CITIZEN</b></p> <p>LED CLL03x/CLU03x            FWHM / FWTM 37.0° / 96.0°            Efficiency 92 %            Peak intensity 1.4 cd/lm            LEDs/each optic 1            Light colour White            Required components:            BJB: 47.319.2021</p>		
<p><b>CITIZEN</b></p> <p>LED CLL03x/CLU03x            FWHM / FWTM 43.0° / 99.0°            Efficiency 89 %            Peak intensity 1.1 cd/lm            LEDs/each optic 1            Light colour White            Required components:            F13671_ANGE-RZ-LENS            A.A.G. STUCCHI: 8101-G2</p>		

#### OPTICAL RESULTS (MEASURED):

#### CITIZEN

LED CLL03x/CLU03x  
 FWHM / FWTM 39.0° / 98.0°  
 Efficiency 94 %  
 Peak intensity 1.2 cd/lm  
 LEDs/each optic 1  
 Light colour White  
 Required components:  
 A.A.G. STUCCHI: 8101-G2

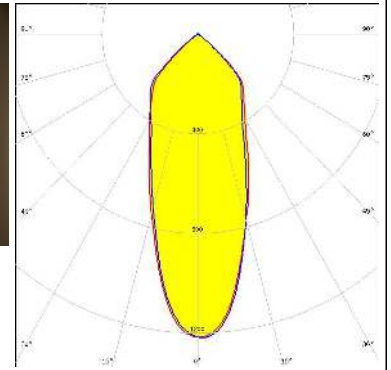
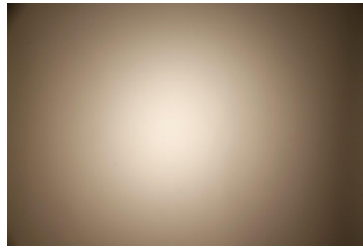

#### CITIZEN

LED CLL04x/CLU04x  
 FWHM / FWTM 39.0° / 98.0°  
 Efficiency 94 %  
 Peak intensity 1.2 cd/lm  
 LEDs/each optic 1  
 Light colour White  
 Required components:  
 A.A.G. STUCCHI: 8102-G2

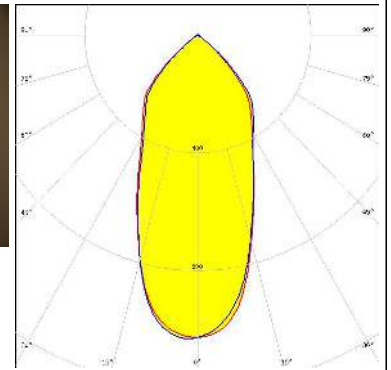
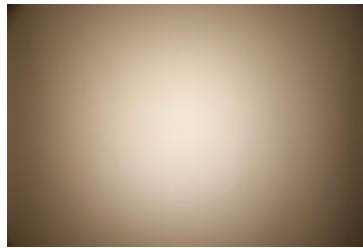

#### CITIZEN

LED CLL04x/CLU04x  
 FWHM / FWTM 50.0° / 101.0°  
 Efficiency 87 %  
 Peak intensity 0.9 cd/lm  
 LEDs/each optic 1  
 Light colour White  
 Required components:  
 F13671\_ANGE-RZ-LENS  
 A.A.G. STUCCHI: 8102-G2

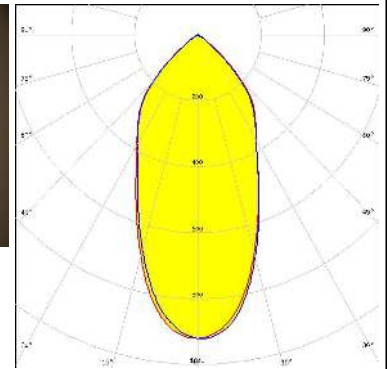
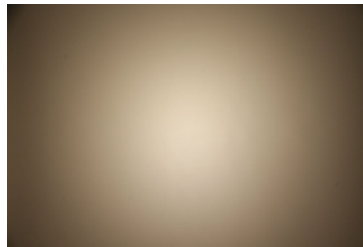

#### CITIZEN

LED CLU720/721/723  
 FWHM / FWTM 34.0° / 96.0°  
 Efficiency 94 %  
 Peak intensity 1.4 cd/lm  
 LEDs/each optic 1  
 Light colour White  
 Required components:  
 BJB: 47.319.2021

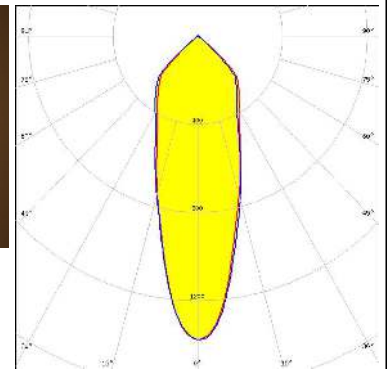
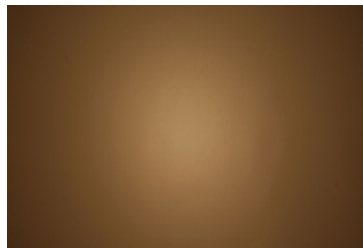

#### OPTICAL RESULTS (MEASURED):

#### CITIZEN

LED CLU720/721/723  
 FWHM / FWTM 35.0° / 97.0°  
 Efficiency 94 %  
 Peak intensity 1.3 cd/lm  
 LEDs/each optic 1  
 Light colour White  
 Required components:  
 A.A.G. STUCCHI: 8101-G2

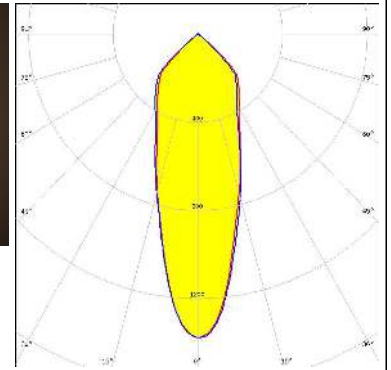
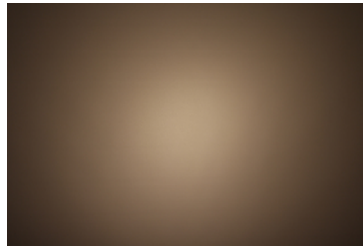

#### CREE LED

LED CXA/B 25xx  
 FWHM / FWTM 44.0° / 98.0°  
 Efficiency 92 %  
 Peak intensity 1.1 cd/lm  
 LEDs/each optic 1  
 Light colour White  
 Required components:  
 BJB: 47.319.2141

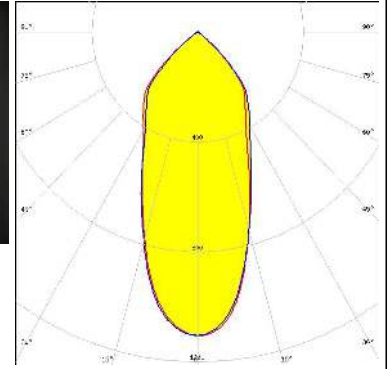
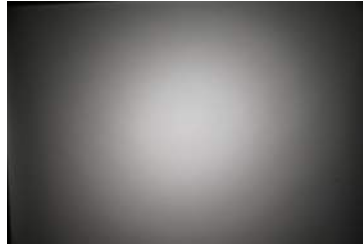

#### CREE LED

LED CXA/B 25xx  
 FWHM / FWTM 42.0° / 98.0°  
 Efficiency 93 %  
 Peak intensity 1.1 cd/lm  
 LEDs/each optic 1  
 Light colour White  
 Required components:  
 A.A.G. STUCCHI: 8401-G2

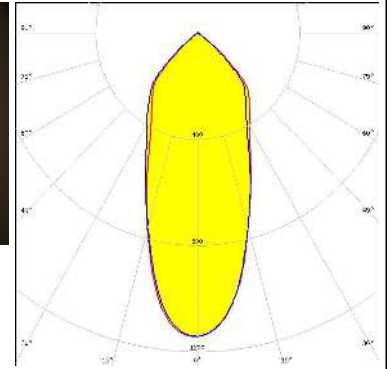
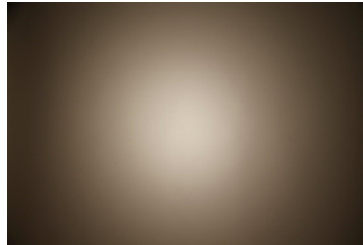

#### CREE LED

LED CXA/B 25xx  
 FWHM / FWTM 46.0° / 99.0°  
 Efficiency 89 %  
 Peak intensity 1 cd/lm  
 LEDs/each optic 1  
 Light colour White  
 Required components:  
 F13671\_ANGE-RZ-LENS  
 BJB: 47.319.2141

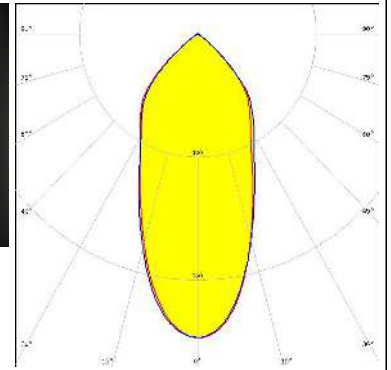
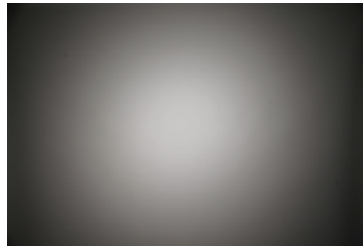

#### OPTICAL RESULTS (MEASURED):

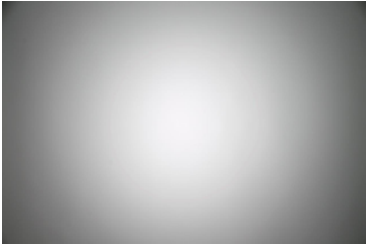
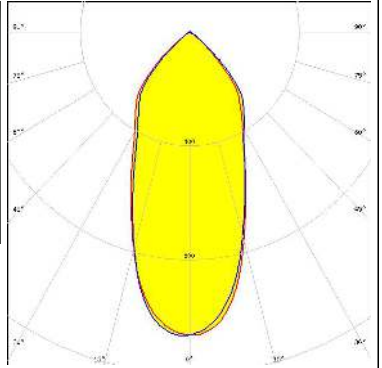
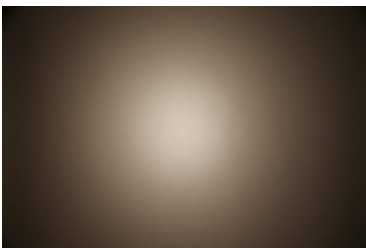
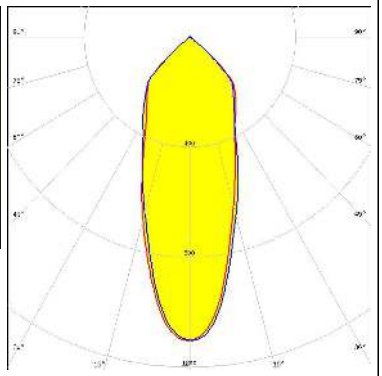
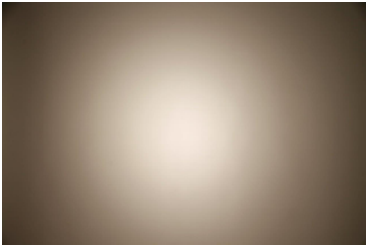
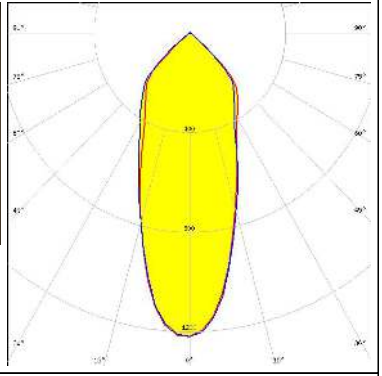
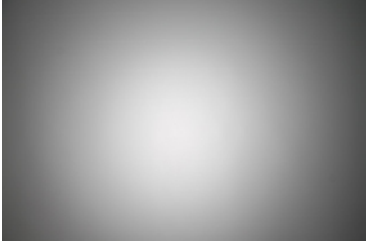
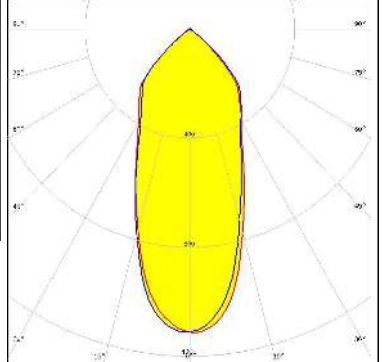

<p><b>CREE</b> LED</p> <p>LED CXA/B 30xx            FWHM / FWTM 45.0° / 98.0°            Efficiency 92 %            Peak intensity 1.1 cd/lm            LEDs/each optic 1            Light colour White            Required components:            A.A.G. STUCCHI: 8404-G2</p>		
<p><b>LUMILEDS</b></p> <p>LED LUXEON CoB 1204/1205            FWHM / FWTM 38.0° / 97.0°            Efficiency 94 %            Peak intensity 1.3 cd/lm            LEDs/each optic 1            Light colour White            Required components:            A.A.G. STUCCHI: 8301-G2</p>		
<p><b>LUMILEDS</b></p> <p>LED LUXEON CoB 1208            FWHM / FWTM 39.0° / 97.0°            Efficiency 94 %            Peak intensity 1.2 cd/lm            LEDs/each optic 1            Light colour White            Required components:            A.A.G. STUCCHI: 8301-G2</p>		
<p><b>LUMILEDS</b></p> <p>LED LUXEON CoB 1211            FWHM / FWTM 44.0° / 98.0°            Efficiency 92 %            Peak intensity 1.1 cd/lm            LEDs/each optic 1            Light colour White            Required components:            BJB: 47.319.2030</p>		

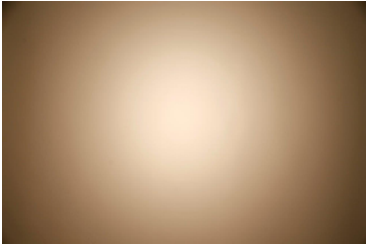
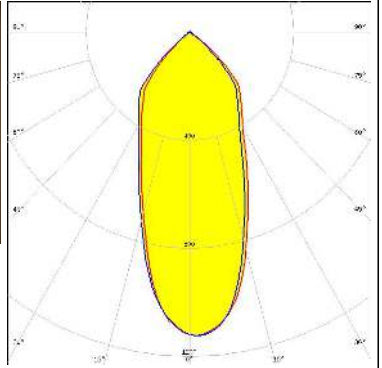
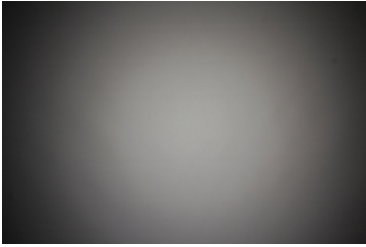
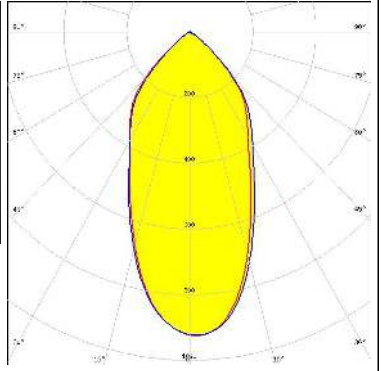
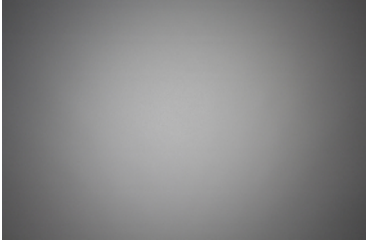
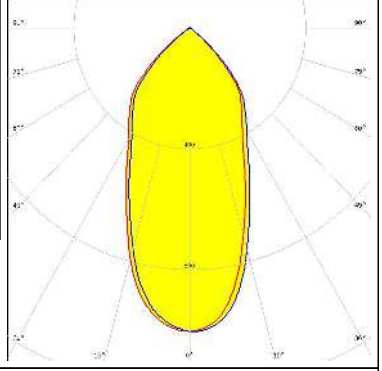
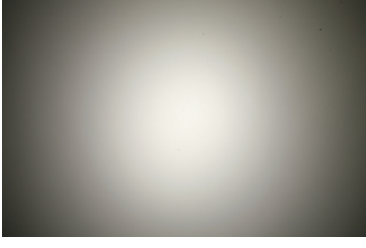
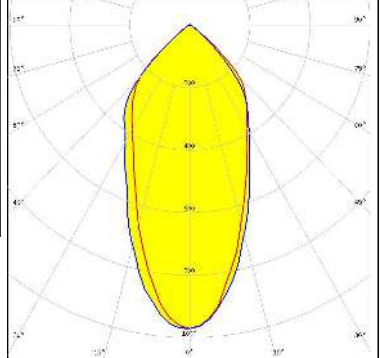
#### OPTICAL RESULTS (MEASURED):

<p><b>LUMILEDS</b></p> <p>LED LUXEON CoB 1211</p> <p>FWHM / FWTM 43.0° / 97.0°</p> <p>Efficiency 92 %</p> <p>Peak intensity 1.1 cd/lm</p> <p>LEDs/each optic 1</p> <p>Light colour White</p> <p>Required components: A.A.G. STUCCHI: 8102-G2</p>		
<p><b>LUMILEDS</b></p> <p>LED LUXEON CoB 1216/1812</p> <p>FWHM / FWTM 50.0° / 100.0°</p> <p>Efficiency 88 %</p> <p>Peak intensity 0.9 cd/lm</p> <p>LEDs/each optic 1</p> <p>Light colour White</p> <p>Required components: F13671_ANGE-RZ-LENS BJB: 47.319.2030</p>		
<p><b>LUMILEDS</b></p> <p>LED LUXEON CoB 1216/1812</p> <p>FWHM / FWTM 49.0° / 99.0°</p> <p>Efficiency 91 %</p> <p>Peak intensity 1 cd/lm</p> <p>LEDs/each optic 1</p> <p>Light colour White</p> <p>Required components: BJB: 47.319.2030</p>		
<p><b>LUMILEDS</b></p> <p>LED LUXEON K12</p> <p>FWHM / FWTM 48.0° / 101.0°</p> <p>Efficiency 89 %</p> <p>Peak intensity 1 cd/lm</p> <p>LEDs/each optic 1</p> <p>Light colour White</p> <p>Required components: F13671_ANGE-RZ-LENS BJB: 47.319.2070</p>		

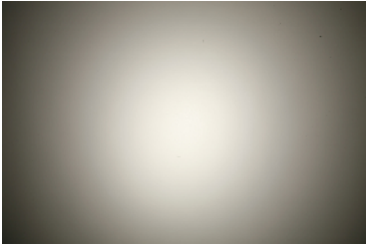
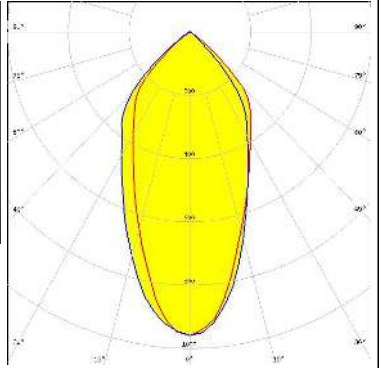

#### OPTICAL RESULTS (MEASURED):

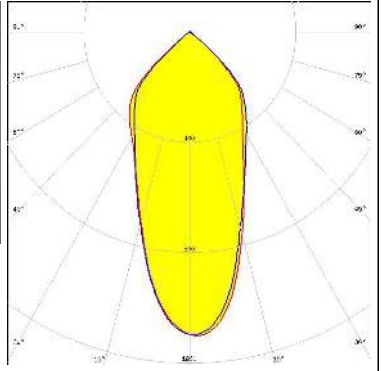
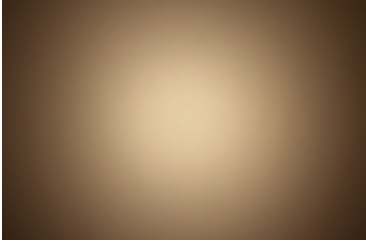
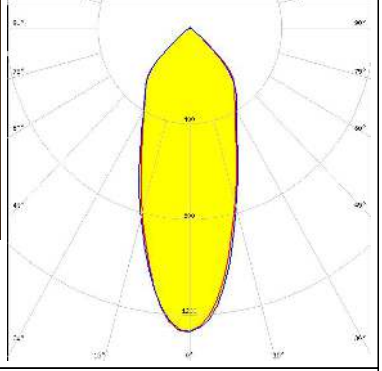
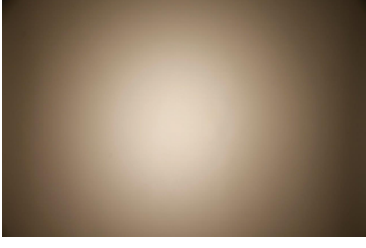
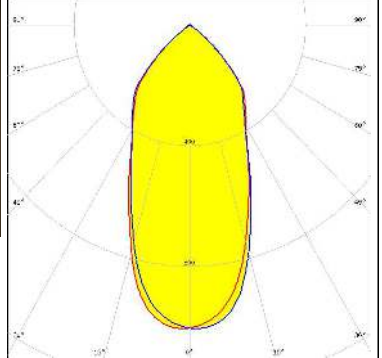
<p><b>LUMILEDS</b></p> <p>LED LUXEON K16            FWHM / FWTM 50.0° / 101.0°            Efficiency 89 %            Peak intensity 1 cd/lm            LEDs/each optic 1            Light colour White            Required components:            F13671_ANGE-RZ-LENS            BJB: 47.319.2070</p>		
<p><b>LUMILEDS</b></p> <p>LED LUXEON K16            FWHM / FWTM 44.0° / 98.0°            Efficiency 94 %            Peak intensity 1.1 cd/lm            LEDs/each optic 1            Light colour White            Required components:            BJB: 47.319.2070</p>		
<p><b>LUMINUS</b></p> <p>LED CxM-14 (19x19)            FWHM / FWTM 40.0° / 98.0°            Efficiency 94 %            Peak intensity 1.3 cd/lm            LEDs/each optic 1            Light colour White            Required components:            BJB: 47.319.2021</p>		
<p><b>LUMINUS</b></p> <p>LED CxM-22 (28x28)            FWHM / FWTM 48.0° / 99.0°            Efficiency 92 %            Peak intensity 1 cd/lm            LEDs/each optic 1            Light colour White            Required components:            BJB: 47.319.2030</p>		

#### OPTICAL RESULTS (MEASURED):

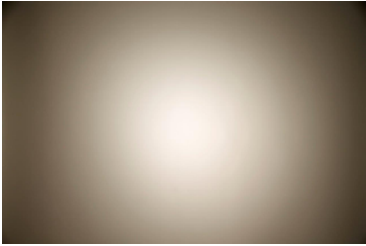
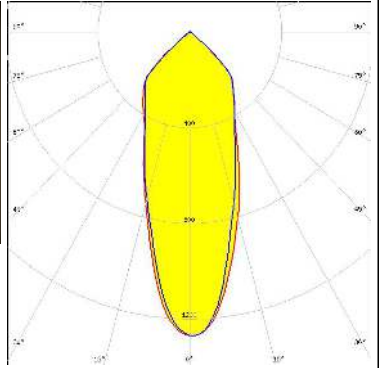
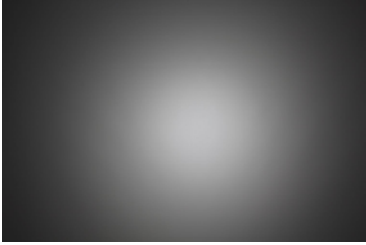
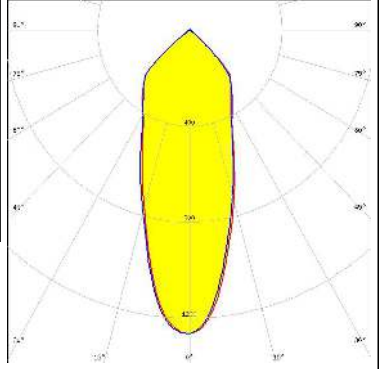
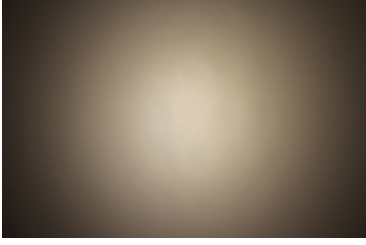
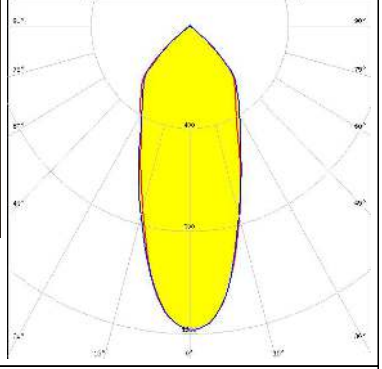
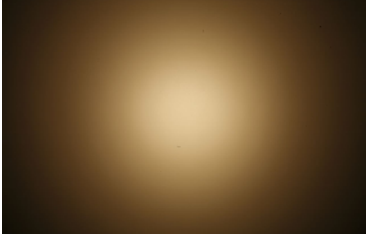
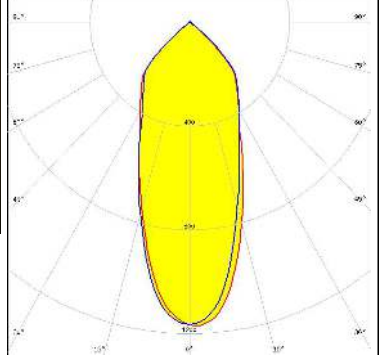
<p><b>OSRAM</b> Opto Semiconductors</p> <p>LED Soleriq S13</p> <p>FWHM / FWTM 37.0° / 98.0°</p> <p>Efficiency 94 %</p> <p>Peak intensity 1.3 cd/m</p> <p>LEDs/each optic 1</p> <p>Light colour White</p> <p>Required components: A.A.G. STUCCHI: 8502-G2</p>		
<p><b>OSRAM</b> Opto Semiconductors</p> <p>LED Soleriq S13 19x19</p> <p>FWHM / FWTM 37.0° / 97.0°</p> <p>Efficiency 93 %</p> <p>Peak intensity 0.9 cd/m</p> <p>LEDs/each optic 1</p> <p>Light colour White</p> <p>Required components: BJB: 47.319.2021</p>		
<p><b>OSRAM</b> Opto Semiconductors</p> <p>LED Soleriq S19</p> <p>FWHM / FWTM 41.0° / 97.0°</p> <p>Efficiency 93 %</p> <p>Peak intensity 1.2 cd/m</p> <p>LEDs/each optic 1</p> <p>Light colour White</p> <p>Required components: A.A.G. STUCCHI: 8503-G2</p>		
<p><b>OSRAM</b> Opto Semiconductors</p> <p>LED Soleriq S19</p> <p>FWHM / FWTM 41.0° / 98.0°</p> <p>Efficiency 94 %</p> <p>Peak intensity 1.2 cd/m</p> <p>LEDs/each optic 1</p> <p>Light colour White</p> <p>Required components: BJB: 47.319.2170</p>		

#### OPTICAL RESULTS (MEASURED):

#### PHILIPS

LED Fortimo SLM L19 CoB  
 FWHM / FWTM 40.0° / 97.0°  
 Efficiency 93 %  
 Peak intensity 1.2 cd/lm  
 LEDs/each optic 1  
 Light colour White  
 Required components:  
 BJB: 47.319.2030

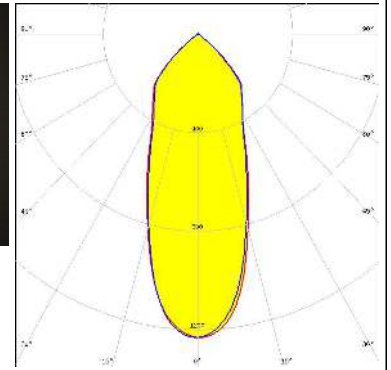
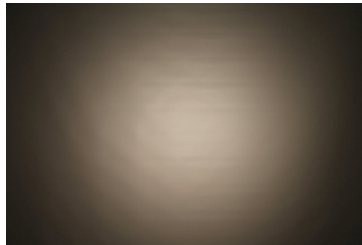

#### PHILIPS

LED Fortimo SLM L19 CoB  
 FWHM / FWTM 42.0° / 98.0°  
 Efficiency 88 %  
 Peak intensity 1.1 cd/lm  
 LEDs/each optic 1  
 Light colour White  
 Required components:  
 F13671\_ANGE-RZ-LENS  
 BJB: 47.319.2030

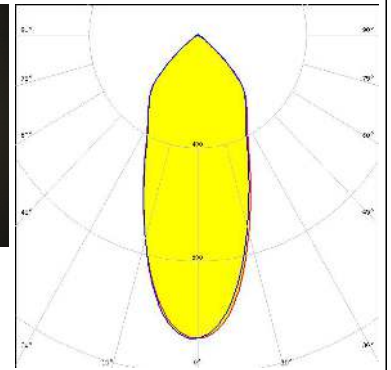
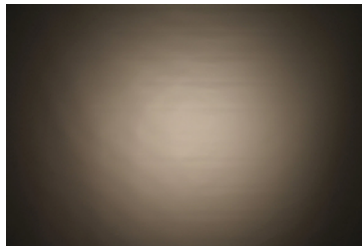

#### PHILIPS

LED Fortimo SLM L23 CoB  
 FWHM / FWTM 44.0° / 98.0°  
 Efficiency 93 %  
 Peak intensity 1.1 cd/lm  
 LEDs/each optic 1  
 Light colour White  
 Required components:  
 BJB: 47.319.2030

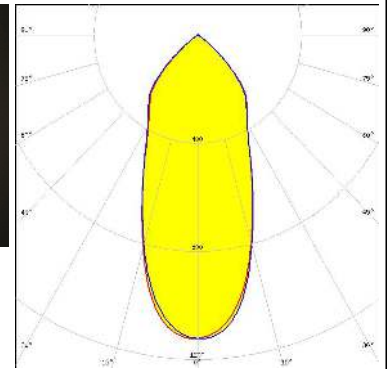
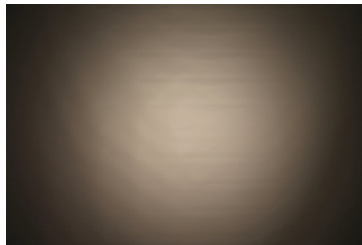

#### PHILIPS

LED Fortimo SLM L23 CoB  
 FWHM / FWTM 45.0° / 99.0°  
 Efficiency 88 %  
 Peak intensity 1 cd/lm  
 LEDs/each optic 1  
 Light colour White  
 Required components:  
 F13671\_ANGE-RZ-LENS  
 BJB: 47.319.2030

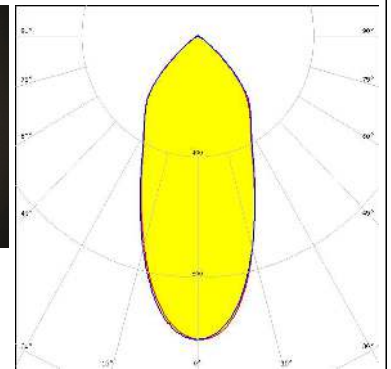
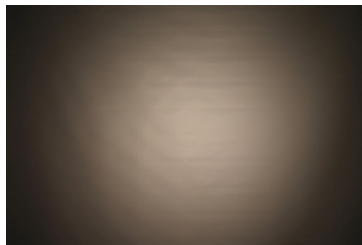

#### OPTICAL RESULTS (MEASURED):

### SAMSUNG

LED LC016D / LC019D / LC026D / LC033D  
 FWHM / FWTM 45.0° / 100.0°  
 Efficiency 89 %  
 Peak intensity 1 cd/m  
 LEDs/each optic 1  
 Light colour White  
 Required components:  
 F13671\_ANGE-RZ-LENS  
 BJB: 47.319.2021

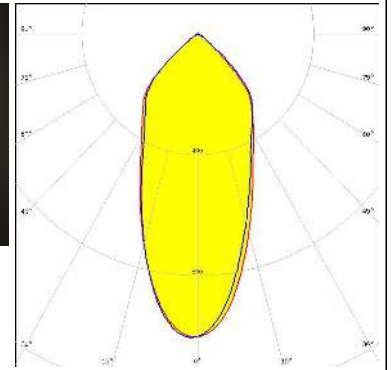
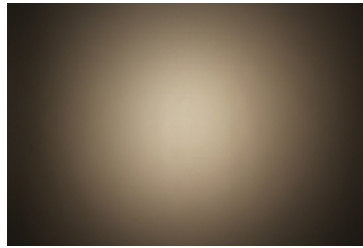

### SAMSUNG

LED LC016D / LC019D / LC026D / LC033D  
 FWHM / FWTM 41.0° / 98.0°  
 Efficiency 93 %  
 Peak intensity 1.2 cd/m  
 LEDs/each optic 1  
 Light colour White  
 Required components:  
 BJB: 47.319.2021

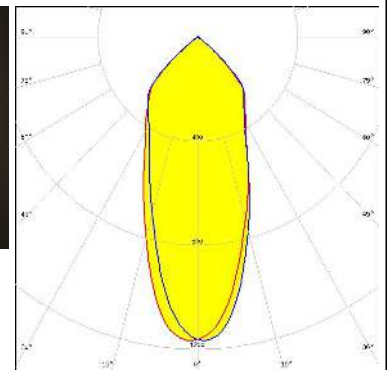
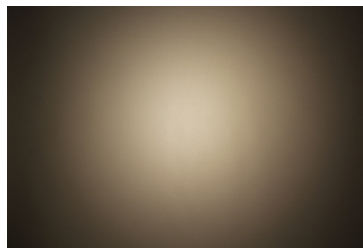

### SAMSUNG

LED LC016D / LC019D / LC026D / LC033D  
 FWHM / FWTM 45.0° / 100.0°  
 Efficiency 89 %  
 Peak intensity 1 cd/m  
 LEDs/each optic 1  
 Light colour White  
 Required components:  
 F13671\_ANGE-RZ-LENS  
 A.A.G. STUCCHI: 8101-G2

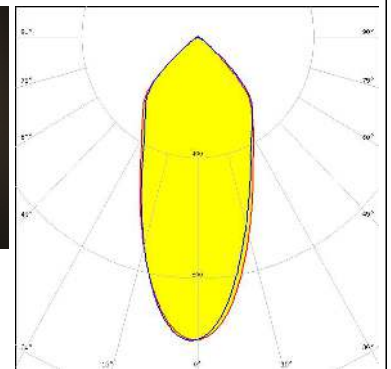
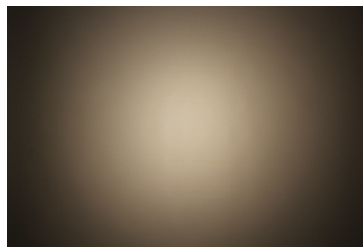



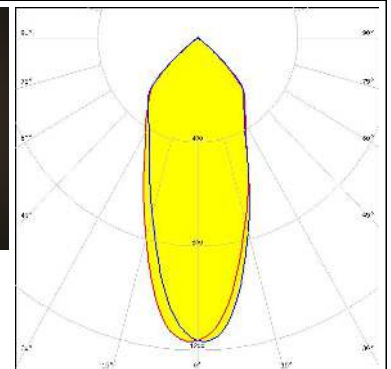
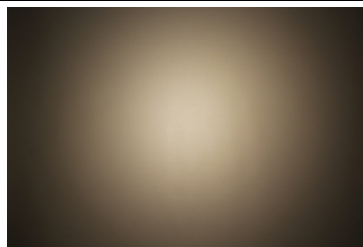

### SAMSUNG

LED LC016D / LC019D / LC026D / LC033D  
 FWHM / FWTM 41.0° / 98.0°  
 Efficiency 93 %  
 Peak intensity 1.2 cd/m  
 LEDs/each optic 1  
 Light colour White  
 Required components:  
 A.A.G. STUCCHI: 8101-G2

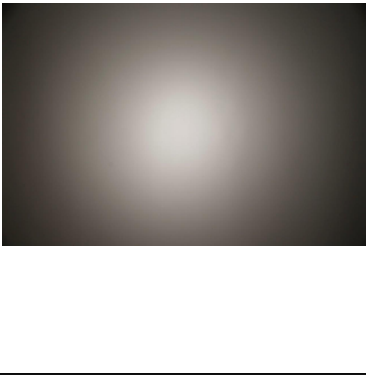
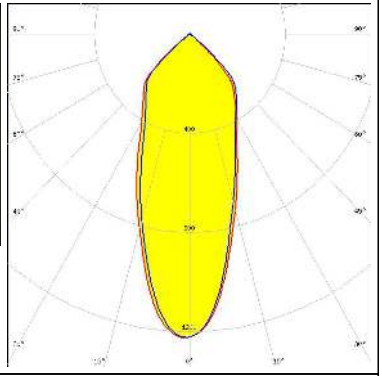

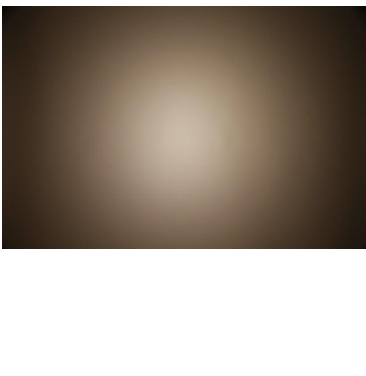
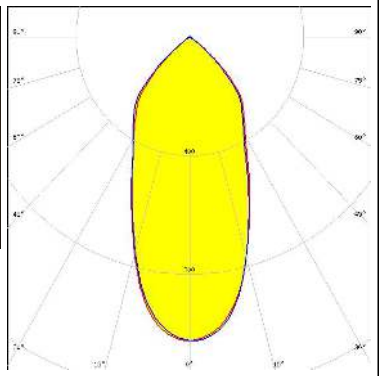
#### OPTICAL RESULTS (MEASURED):

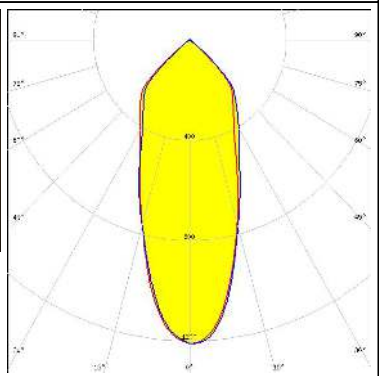
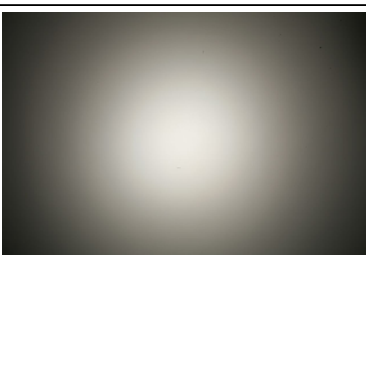
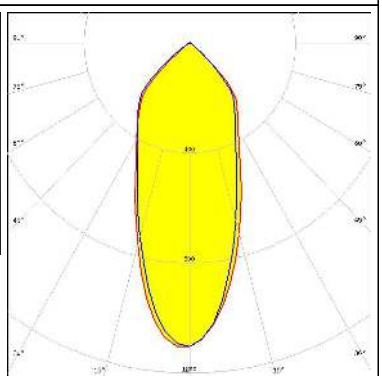
<p> SEOUL SEMICONDUCTOR</p> <p>LED ZC12/18</p> <p>FWHM / FWTM 39.0° / 97.0°</p> <p>Efficiency 93 %</p> <p>Peak intensity 1.2 cd/lm</p> <p>LEDs/each optic 1</p> <p>Light colour White</p> <p>Required components: A.A.G. STUCCHI: 8101-G2</p>		
<p> SEOUL SEMICONDUCTOR</p> <p>LED ZC25/40/60</p> <p>FWHM / FWTM 47.0° / 99.0°</p> <p>Efficiency 92 %</p> <p>Peak intensity 1 cd/lm</p> <p>LEDs/each optic 1</p> <p>Light colour White</p> <p>Required components: A.A.G. STUCCHI: 8102-G2</p>		
<p><b>SHARP</b></p> <p>LED Mega Zenigata (GW6DME)</p> <p>FWHM / FWTM 40.0° / 98.0°</p> <p>Efficiency 94 %</p> <p>Peak intensity 1.2 cd/lm</p> <p>LEDs/each optic 1</p> <p>Light colour White</p> <p>Required components: A.A.G. STUCCHI: 8301-G2</p>		
<p><b>SHARP</b></p> <p>LED Tiger Zenigata (GWTGCBG4FD)</p> <p>FWHM / FWTM 41.0° / 99.0°</p> <p>Efficiency 90 %</p> <p>Peak intensity 1.1 cd/lm</p> <p>LEDs/each optic 1</p> <p>Light colour White</p> <p>Required components: F13671_ANGE-RZ-LENS BJB: 47.319.2051</p>		

#### OPTICAL RESULTS (MEASURED):

#### TRIDONIC

LED SLE G7 LES17 H  
 FWHM / FWTM 38.0° / 96.0°  
 Efficiency 91 %  
 Peak intensity 1.2 cd/lm  
 LEDs/each optic 1  
 Light colour White  
 Required components:

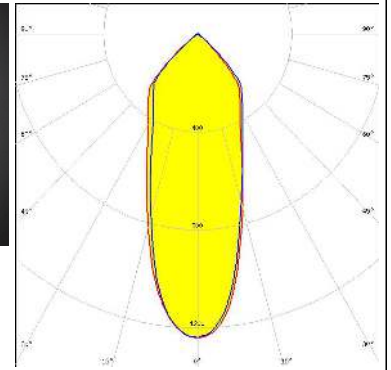

#### TRIDONIC

LED SLE G7 LES21 H  
 FWHM / FWTM 43.0° / 97.0°  
 Efficiency 91 %  
 Peak intensity 1.1 cd/lm  
 LEDs/each optic 1  
 Light colour White  
 Required components:

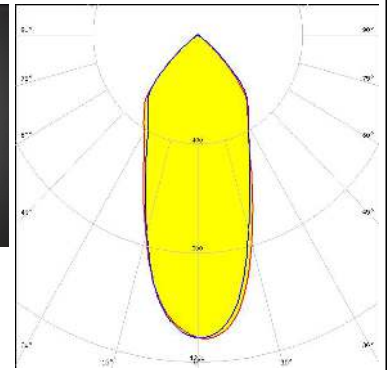
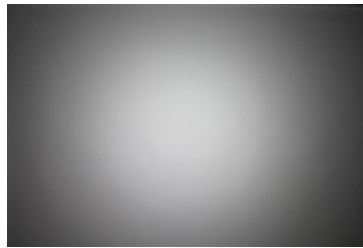

#### XICATO

LED XO B 14.5 mm  
 FWHM / FWTM 40.0° / 98.0°  
 Efficiency 94 %  
 Peak intensity 1.2 cd/lm  
 LEDs/each optic 1  
 Light colour White  
 Required components:  
 BJB: 47.319.2021

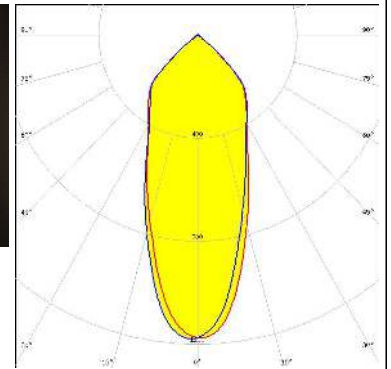
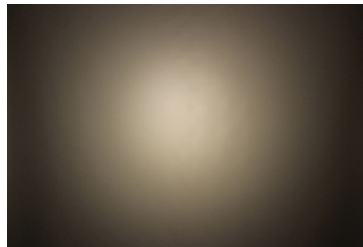

#### XICATO

LED XTM - 19mm LES  
 FWHM / FWTM 43.0° / 98.0°  
 Efficiency 93 %  
 Peak intensity 1.1 cd/lm  
 LEDs/each optic 1  
 Light colour White  
 Required components:  
 C15743\_XTM-ADAPTER-50-B

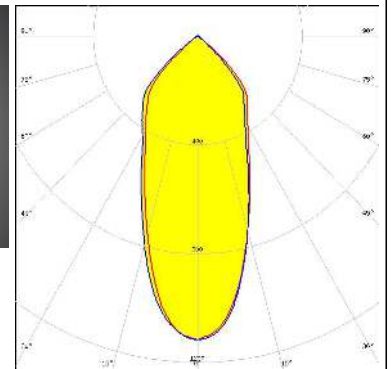
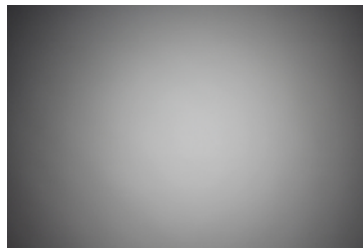

#### OPTICAL RESULTS (SIMULATED):

### CITIZEN

LED CLL04x/CLU04x  
FWHM / FWTM 37.0° / 90.0°  
Efficiency 95 %  
Peak intensity 1.6 cd/lm  
LEDs/each optic 1  
Light colour White  
Required components:  
BJB: 47.319.2030

### CITIZEN

LED CLU730/731/733  
FWHM / FWTM 37.0° / 93.0°  
Efficiency 91 %  
Peak intensity 1.6 cd/lm  
LEDs/each optic 1  
Light colour White  
Required components:  
BJB: 47.319.2030

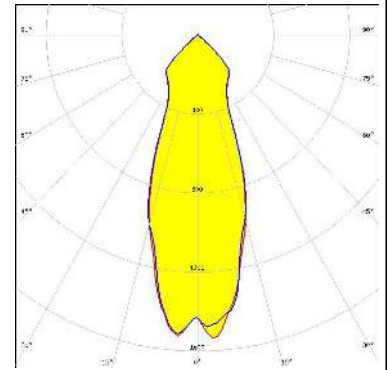

### SAMSUNG

LED LC040D / LC060D / LC080D  
FWHM / FWTM 41.0° / 94.0°  
Efficiency 90 %  
Peak intensity 1.3 cd/lm  
LEDs/each optic 1  
Light colour White  
Required components:  
BJB: 47.319.2030

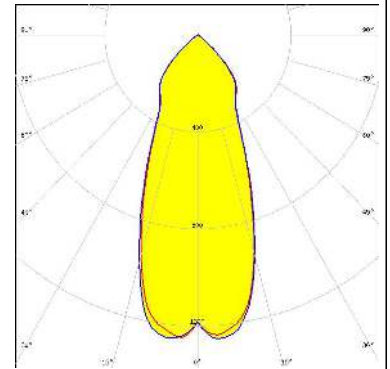

#### GENERAL INFORMATION:

NOTE: The typical beam angle will be changed by different color, chip size and chip position tolerance. The typical total beam angle is the full angle measured where the luminous intensity is half of the peak value.

Due to use of high power COB's with this product, special attention to proper thermal design is highly recommended. LEDiL has no liability for direct, indirect or consecutive damages arising from the LEDiL products being used outside of the recommended temperature range.

#### MATERIALS:

As part of our continuous research and improvement processes, and to ensure the best possible quality and availability of our products, LEDiL reserves the right to change material grades without notice.

#### PRODUCT DATA USER AGREEMENT AND DISCLAIMER:

The measured data in the provided downloadable LEDiL Product Datasheets and Mechanical 2D-Drawings is rounded and provided as reference for planning. LEDiL Oy's optical specifications have been verified by conducting performance testing of the products in accordance with the company's quality system. The reported data are averaged results of multiple measurements with typical variation. LEDiL Oy reserves the right to without prior notification make changes and improvements to its products.

LEDiL Oy assumes neither warranty, nor guarantee nor any other liability of any kind for the contents and correctness of the provided data. The provided data has been generated with highest diligence but the provided data may in reality not represent the complete possible variation range of all intrinsic parameters. Therefore, in certain cases a deviation from the provided data could occur.

LEDiL Oy reserves the right to undertake technical changes of its products without further notification which could lead to changes in the provided data. LEDiL Oy assumes no liability of any kind for the possible deviation from any provided data or any other damage resulting from the usage of the provided data.

The user agrees to this disclaimer and user agreement with the download or usage of the provided files.

#### LEDiL Oy

Joensuunkatu 13  
FI-24240 SALO  
Finland

#### LEDiL Inc.

228 West Page Street  
Suite D  
Sycamore IL 60178  
USA

#### Ledil Optics Technology (Shenzhen) Co., Ltd.

# 405 , Block B  
Casic Motor Building  
Shenzhen 518057  
P.R.CHINA

#### Local sales and technical support

[www.ledil.com/  
where\\_to\\_buy](http://www.ledil.com/where_to_buy)

#### Shipping locations

Salo, Finland  
Hong Kong, China

#### Distribution Partners

[www.ledil.com/  
where\\_to\\_buy](http://www.ledil.com/where_to_buy)