

Miniature solid-state relay - SIM-EI- 12DC/48DC/100 - 2271060

Please be informed that the data shown in this PDF Document is generated from our Online Catalog. Please find the complete data in the user's documentation. Our General Terms of Use for Downloads are valid (<http://phoenixcontact.com/download>)



Input solid-state relay, with protective circuit in input and output circuits, input: 12 V DC, output: 8 - 48 V DC/100 mA

The illustration shows version SIM-EI- 5DC/48DC/100



Key commercial data

Packing unit	1 pc
Weight per Piece (excluding packing)	19.77 GRM
Custom tariff number	85364190
Country of origin	Germany

Technical data

Dimensions

Width	13 mm
Height	29 mm
Depth	25 mm

Ambient conditions

Ambient temperature (operation)	-20 °C ... 50 °C
Ambient temperature (storage/transport)	-20 °C ... 70 °C

Input data

Nominal input voltage U_N	12 V DC ± 10 %
Input voltage range in reference to U_N	0.9 ... 1.1
Switching threshold "0" signal in reference to U_N	≤ 0.4
Switching threshold "1" signal in reference to U_N	≥ 0.8
Typical input current at U_N	5.7 mA
Type of protection	Protection against polarity reversal

Miniature solid-state relay - SIM-EI- 12DC/48DC/100 - 2271060

Technical data

Input data

Protective circuit/component	Polarity protection diode
Transmission frequency	600 Hz

Output data

Output voltage range	8 V DC ... 48 V DC
Limiting continuous current	100 mA
Voltage drop at max. limiting continuous current	1 V
Output circuit	2-wire, floating
Type of protection	Protection against polarity reversal
Protective circuit/component	Polarity protection diode

General

Test voltage input/output	2.5 kV (50 Hz, 1 min.)
Mounting position	any
Assembly instructions	Can be aligned with 2 mm spacing
Operating mode	100% operating factor
Standards/regulations	DIN VDE 0110

Classifications

eCl@ss

eCl@ss 4.0	27371102
eCl@ss 4.1	27371102
eCl@ss 5.0	27371001
eCl@ss 5.1	27371001
eCl@ss 6.0	27371001
eCl@ss 7.0	27371001
eCl@ss 8.0	27371001

ETIM

ETIM 2.0	EC001504
ETIM 3.0	EC001504
ETIM 4.0	EC001504
ETIM 5.0	EC001504

UNSPSC

UNSPSC 6.01	30211916
UNSPSC 7.0901	39121542
UNSPSC 11	39121542

Miniature solid-state relay - SIM-EI- 12DC/48DC/100 - 2271060

Classifications

UNSPSC

UNSPSC 12.01	39121542
UNSPSC 13.2	39121542

Approvals

Approvals

Approvals

GOST

Ex Approvals

Approvals submitted

Approval details

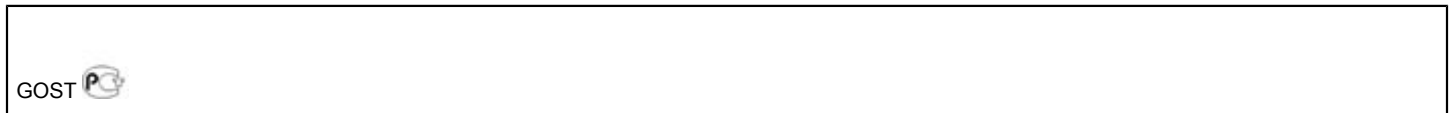

Drawings

Dimensioned drawing

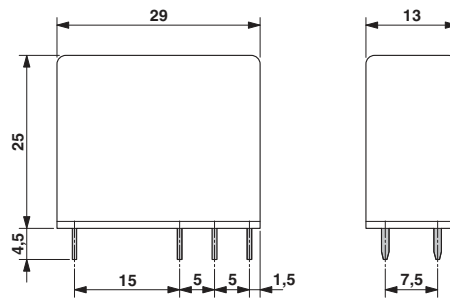

Miniature solid-state relay - SIM-EI- 12DC/48DC/100 - 2271060

Circuit diagram

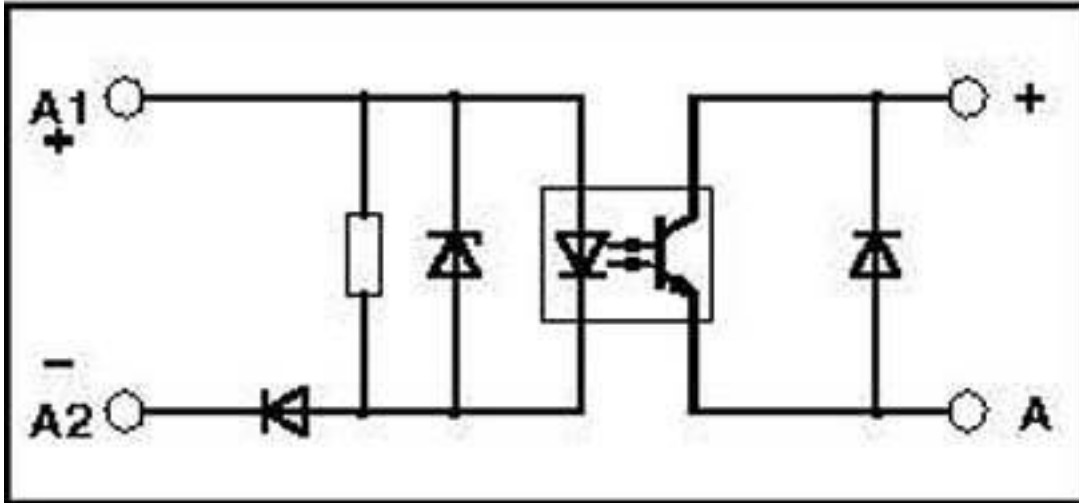

Circuit diagram

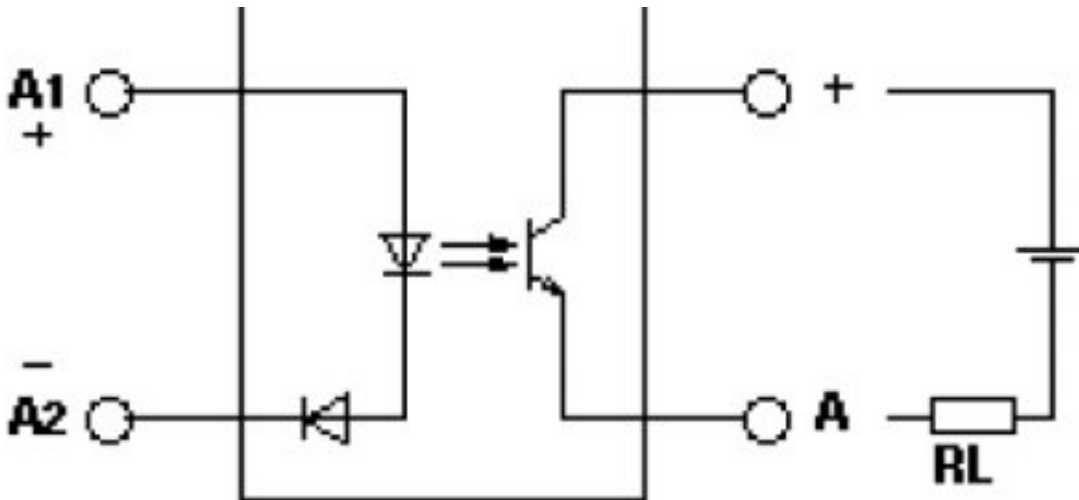

Miniature solid-state relay - SIM-EI- 12DC/48DC/100 - 2271060

Schematic diagram

