

ALM-1322

1.8-2.2GHz Very Low Noise High Gain Balanced Amplifier Module



Data Sheet

Description

Avago Technologies' ALM-1322 is a very low noise, high gain balanced amplifier module operating in the 1.8 to 2.2GHz frequency range. The exceptional noise performance is achieved through the use of Avago Technologies' proprietary 0.5um GaAs Enhancement-mode pHEMT process.

The ALM-1322 is housed in a miniature 5.0 x 6.0 x 1.1 mm³ 22-lead multiple-chips-on-board (MCOB) module package. The compact footprint and low profile makes this product an ideal choice for Wireless Infrastructure Basestation Tower-Mounted Amplifiers (TMA), Radiocards and Multi-Carrier Driver Amplifiers in the cellular/PCS/CDMA bands.

Component Image

5.0 x 6.0 x 1.1 mm³ 22-lead MCOB

TOP VIEW

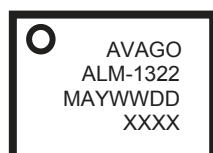

Note:
Package marking provides orientation and identification
"ALM-1322" = Device Part Number
"YWWDD" = Year, work week and day of manufacture
"XXXX" = Assembly lot number

BOTTOM VIEW

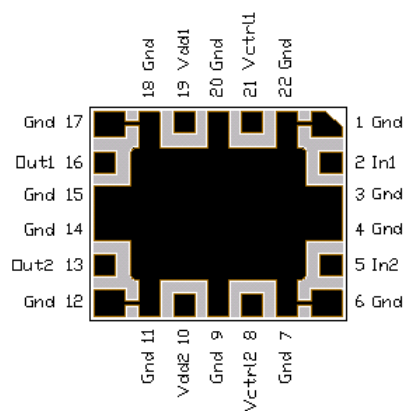

Features

- Very Low noise figure
- High Gain
- GaAs E-pHEMT Technology^[1]
- 50Ω internal matching
- Small package size: 5x6x1.1 mm³
- 5V supply
- Excellent uniformity in product specifications
- Tape-and-Reel packaging option available
- MSL-2a and Lead-free
- Point MTTF > 300 years at 120°C channel temperature
- Specifications
 - 2GHz; 5V, 100mA (typ) per section
 - Vctrl typically at 2.2V
 - 29.9 dB Gain
 - 0.57 dB Noise Figure
 - 35.6 dBm Output IP3
 - 17 dBm Output Power at 1dB gain compression
 - 42 dB Reverse Isolation

Applications

- Diversity Antenna, TMA & Front End LNA for EGSM/PCS/W-CDMA Base Stations.
- Driver amplifier.

Notes:

1. Enhancement mode technology employs positive gate voltage, thereby eliminating the need of negative gate voltage associated with conventional depletion mode devices.



Attention: Observe precautions for handling electrostatic sensitive devices.
ESD Machine Model = 50V
ESD Human Body Model = 250V
Refer to Avago Application Note A004R: Electrostatic Discharge, Damage and Control.

Absolute Maximum Rating ^[2] T_A=25°C

Symbol	Parameter	Units	Absolute Max.
V _{dd}	Device Supply Voltage	V	5.5
V _{ctrl}	Control Voltage	V	3.0
P _{in,max}	CW RF Input Power (V _{dd} = 5.0, V _{ctrl} =2.2V)	dBm	22
P _{diss}	Total Power Dissipation ^[4]	W	1.21
T _j	Junction Temperature	°C	150
T _{STG}	Storage Temperature	°C	-65 to 150

Thermal Resistance ^[3]
(V_{dd} = 5.0V, V_{ctrl}=2.2V)
θ_{jc} = 27 °C/W

Notes:

- Operation of this device in excess of any of these limits may cause permanent damage.
- Thermal resistance measured using Infra-Red Measurement Technique.
- Board (module belly) temperature T_B is 25°C. Derate 37mW/°C for T_B>123°C.

Product Consistency Distribution Charts ^[5,6]

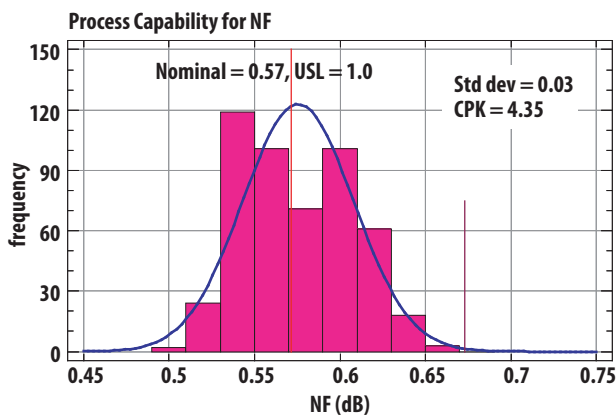

Figure 1. NF@ 2.0GHz; 5V, Vctrl=2.2V

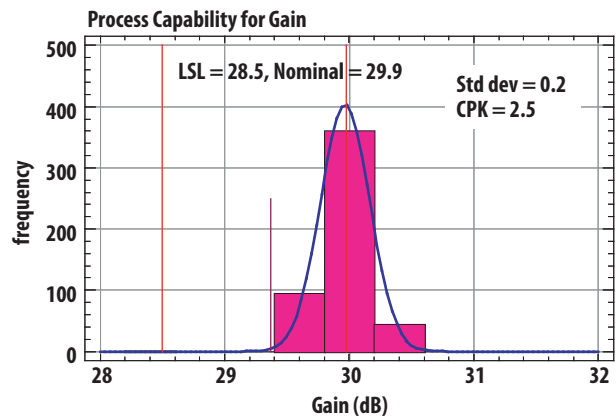

Figure 2. Gain @ 2.0GHz; 5V, Vctrl=2.2V

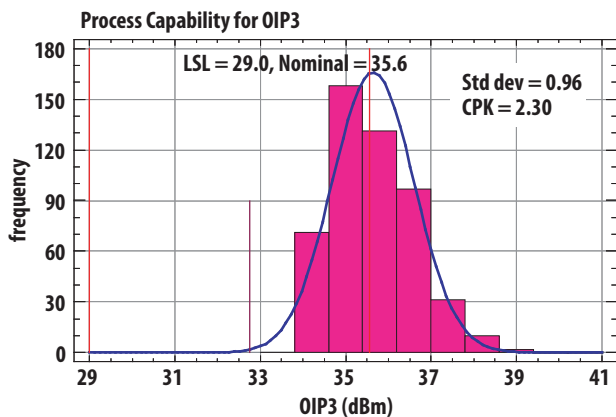

Figure 3. OIP3@ 2.0GHz; 5V, Vctrl=2.2V

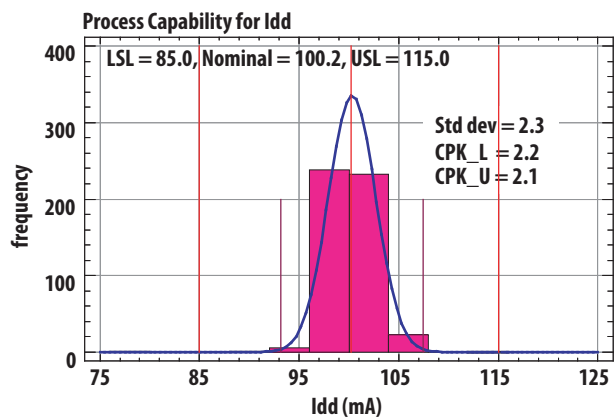

Figure 4. Vctrl @ 2.0GHz; 5V, Vctrl=2.2V

Note:

- Distribution data sample size is 500 samples taken from 3 different wafers and 3 different lots. Future wafers allocated to this product may have nominal values anywhere between the upper and lower limits.
- Measurements are made on a production test board, which can show a variance of up to 1dB in gain and OIP3 compared to a soldered-down demo board. Input trace losses have been de-embedded from actual measurements.

Electrical Specifications [7], [10]

$T_A = 25^\circ\text{C}$, $V_{dd} = 5\text{V}$ @ $V_{ctrl} = 2.2\text{V}$, RF performance at 2.0 GHz, given for each of the 2 RF paths, measured on demo board (see Fig. 5) unless otherwise specified.

Symbol	Parameter and Test Condition	Units	Min.	Typ.	Max.
I _{dd}	Supply Current, $V_{ctrl} = 2.2\text{V}$	mA	85	100.2	115
Gain	Gain	dB	28.5	29.9	31.5
OIP3 [8]	Output Third Order Intercept Point	dBm	31	35.6	–
NF [9]	Noise Figure (Typ. $V_{ctrl} = 2.2\text{V}$)	dB	–	0.57	1.00
OP1dB	Output Power at 1dB Gain Compression	dBm	–	17	–
S11	Input Return Loss, 50Ω source	dB	–	-7	–
S22	Output Return Loss, 50Ω load	dB	–	-17	–
S12	Reverse Isolation	dB	–	42	–
ISO ₁₋₂	Isolation between RF Input 1 and RF Input 2	dB	–	30	–

Notes:

- Measurements at 2GHz obtained using demo board described in Fig 5.
- 2GHz OIP3 test condition: $F_{RF1} = 2.0\text{ GHz}$, $F_{RF2} = 2.01\text{ GHz}$ with input power of -25dBm per tone measured at upper side band.
- For NF data, board losses of 0.12dB at the input have been de-embedded.
- Use proper bias and derating to ensure maximum channel temperature is not exceeded. See absolute maximum ratings and application note for more details.

Demo Board Layout

Circuit Symbol	Size	Description
C1, C10	0805	2.2uF ceramic
C2, C7	0402	Not used
C3, C6	0402	0.1uF ceramic
C4, C9	0402	Not used
C5, C8	0402	0.1uF ceramic

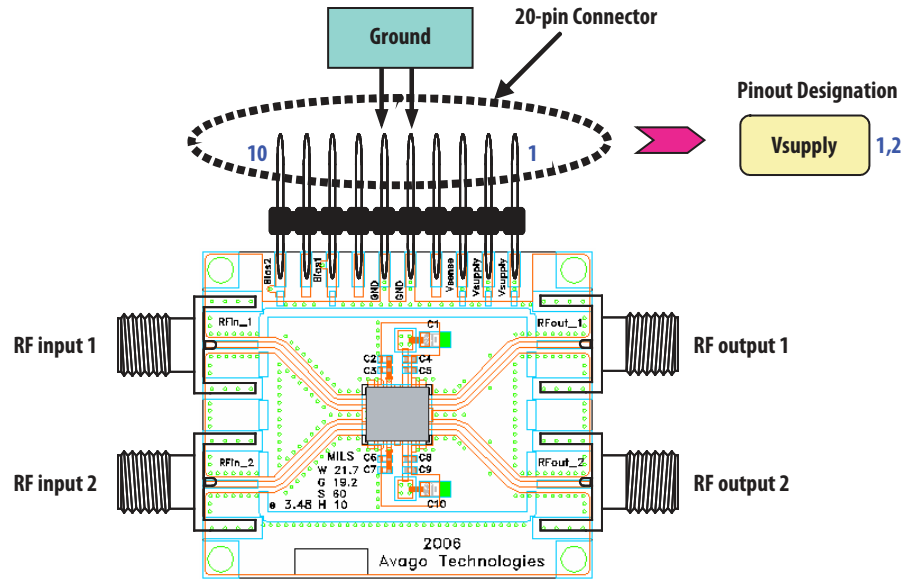

Figure 5. Demo Board Layout Diagram

Recommended PCB material is 10 mils Rogers RO4350.

Suggested component values may vary according to layout and PCB material.

Demo Board Schematic

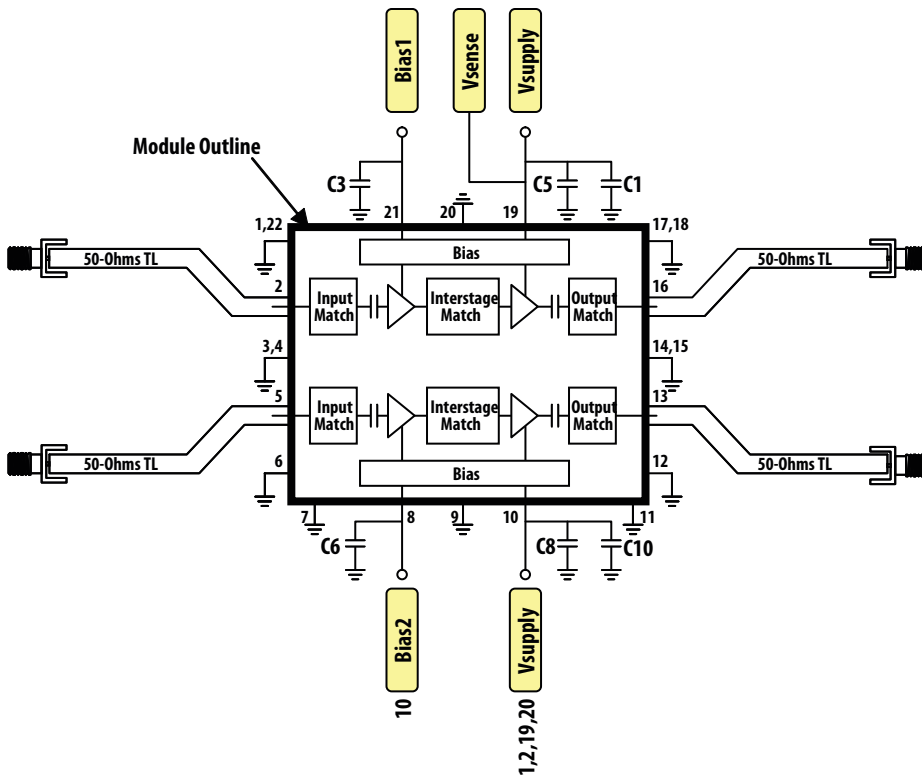

Figure 6. Demo Board Schematic Diagram

Balanced Amplifier Demo Board Layout

Circuit Symbol	Size	Description
C1, C10	0805	2.2uF ceramic
C2, C7	0402	Not used
C3, C6	0402	0.1uF ceramic
C4, C9	0402	Not used
C5, C8	0402	0.1uF ceramic
R1, R4	0402	Not used
R2, R3	0402	49.9 ohms
Coupler	14.22x5.08 mm ²	Anaren Xinger II XC1900E-03 or equiv

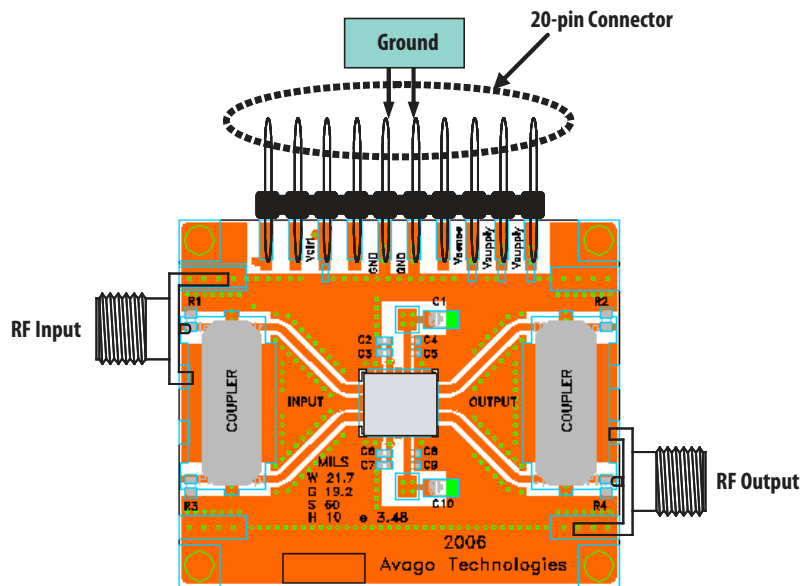

Figure 7. Suggested Balanced Amplifier Demo Board Layout

Recommended PCB material is 10 mils Rogers RO4350.

Suggested component values may vary according to layout and PCB material.

Balanced Demo Board Schematic

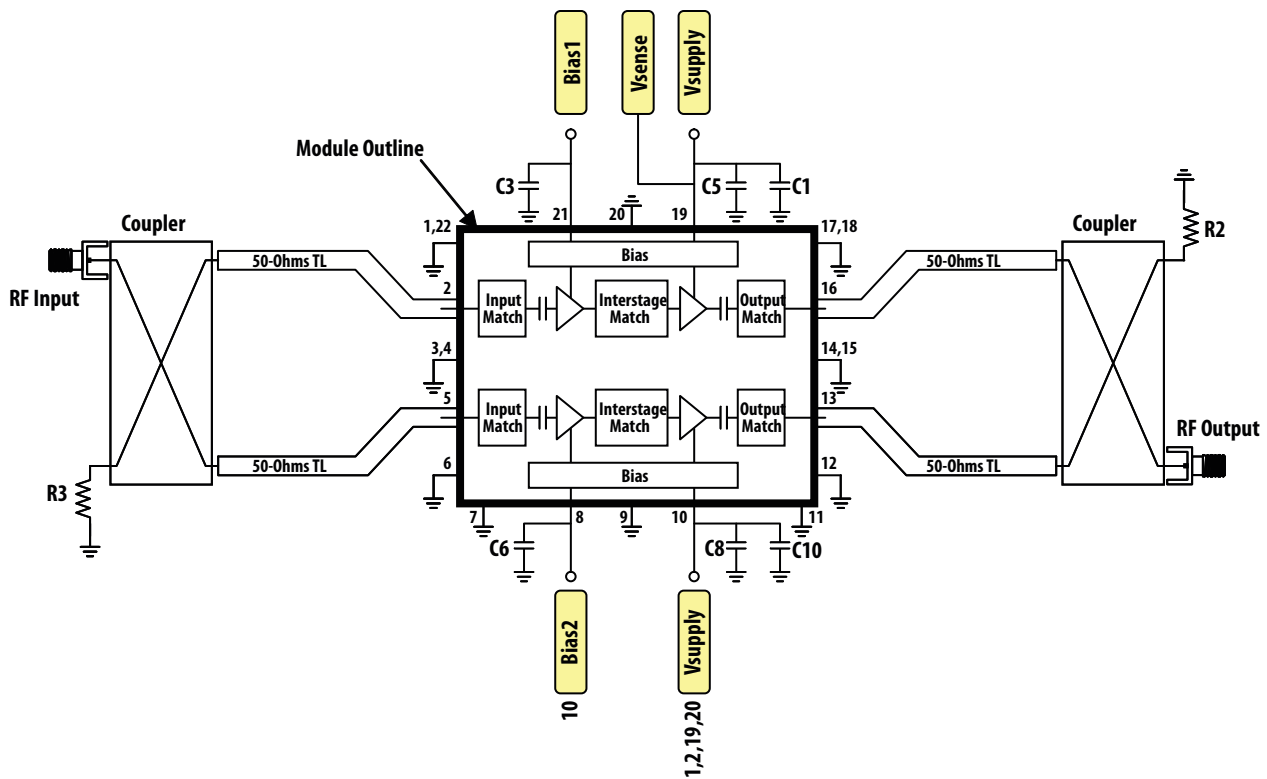

Figure 8. Application Schematic for Balanced Amplifier

ALM-1322 Typical Performance I

T_A = +25°C, V_{dd} = 5V, V_{ctrl} = 2.2V Input Signal=CW unless stated otherwise.

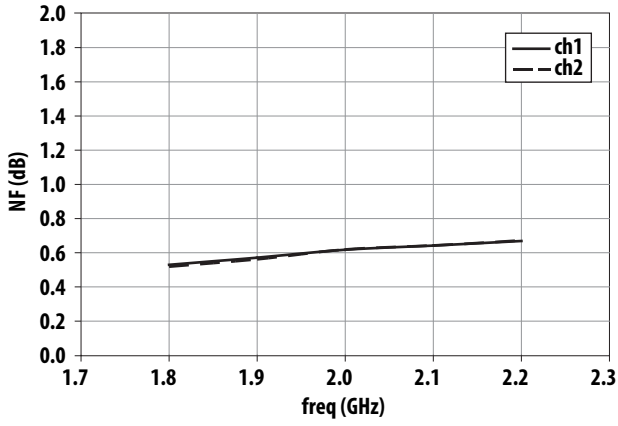

Figure 9. NF vs Frequency and channel

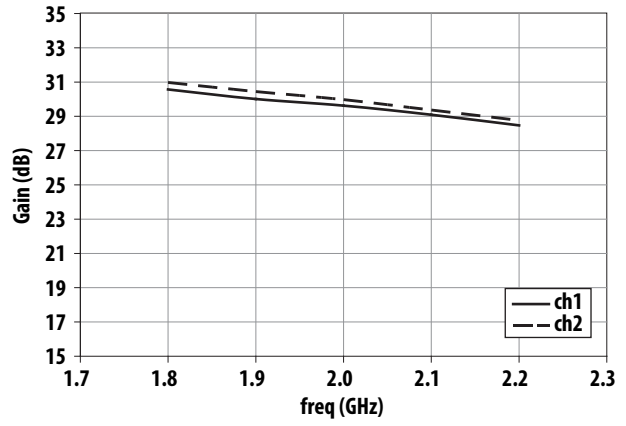

Figure 10. Gain vs Frequency and channel

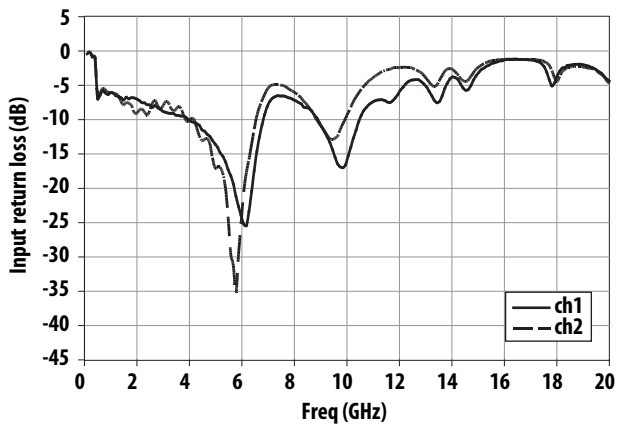

Figure 11. S11 vs Frequency and channel

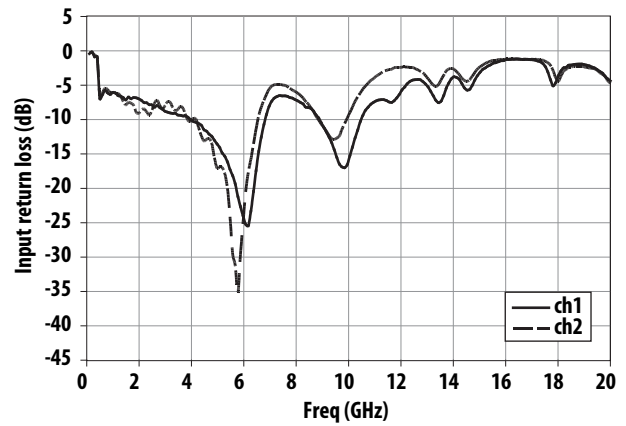

Figure 12. S22 vs Frequency and channel

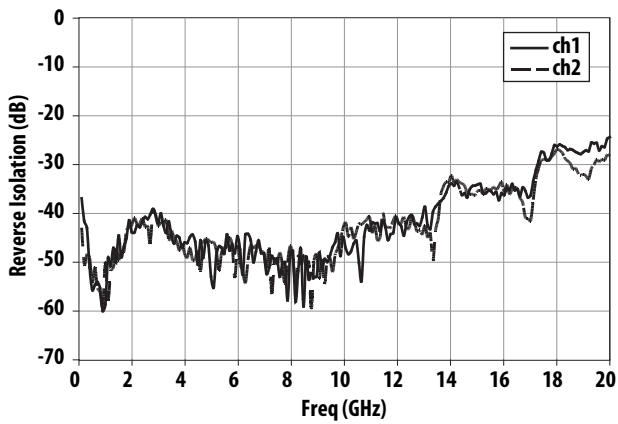

Figure 13. Isolation vs Frequency and channel

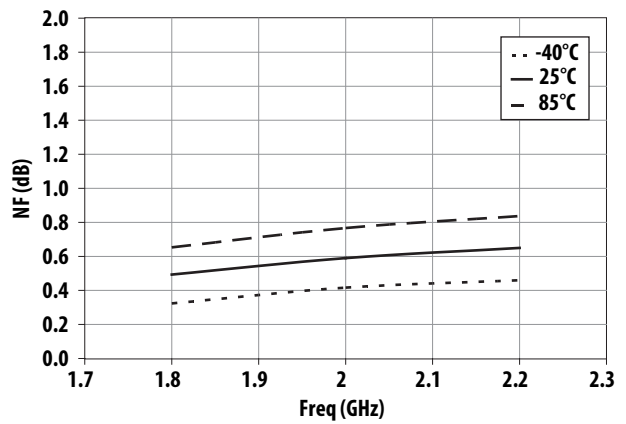

Figure 14. NF vs Frequency and temperature

ALM-1322 Typical Performance I

$T_A = +25^\circ\text{C}$, $V_{dd} = 5\text{V}$, $V_{ctrl} = 2.2\text{V}$ Input Signal=CW unless stated otherwise.

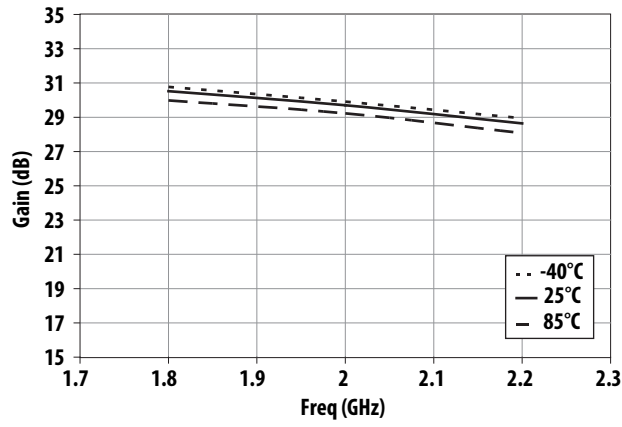

Figure 15. Gain vs Frequency and temperature

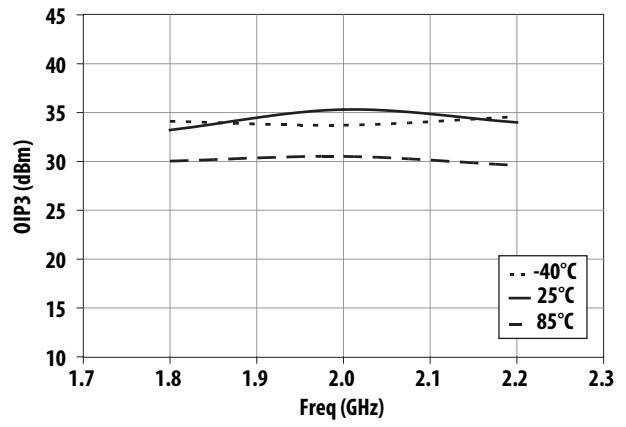

Figure 16. OIP3 vs Frequency and temperature

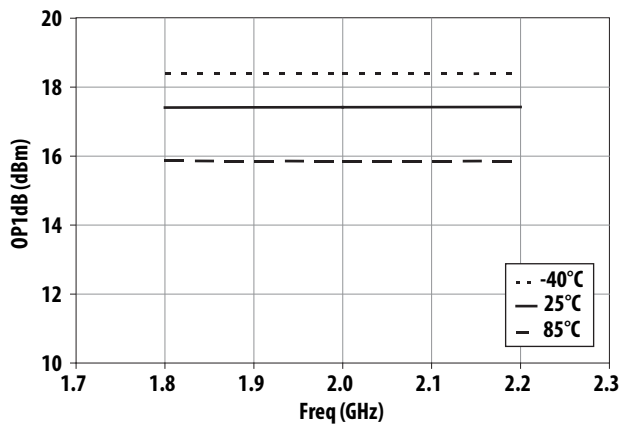

Figure 17. OP1dB vs Frequency and temperature

ALM-1322 Typical Performance II

$T_A = +25^\circ\text{C}$, $V_{dd} = 5\text{V}$, $V_{ctrl} = 2.2\text{V}$, Frequency = 2GHz. Input Signal=CW unless stated otherwise.

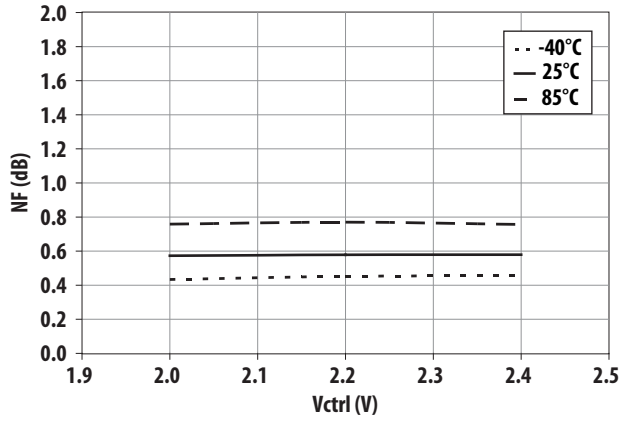

Figure 18. NF vs Vctrl and temperature

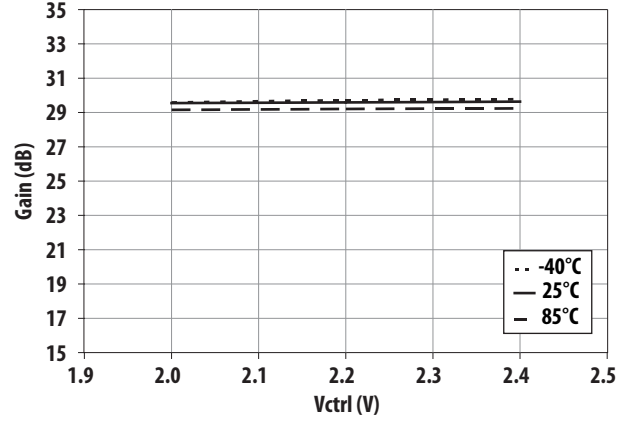

Figure 19. Gain vs Vctrl and temperature

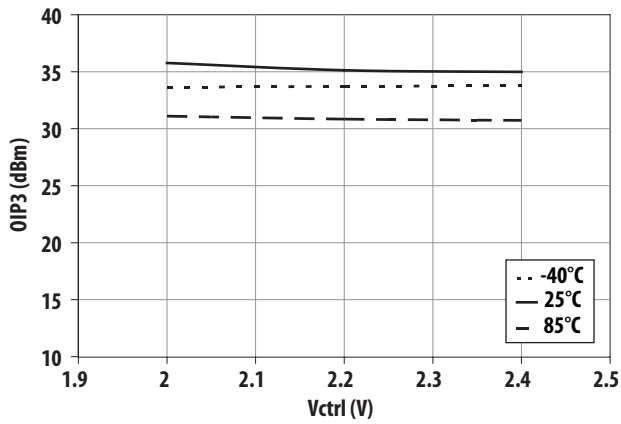

Figure 20. OIP3 vs Vctrl and temperature

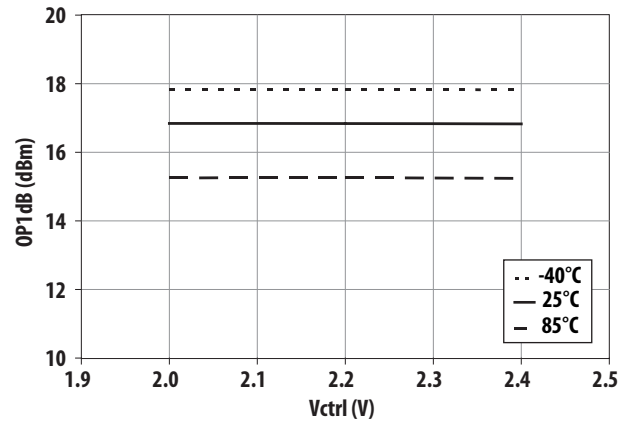

Figure 21. OP1dB vs Vctrl and temperature

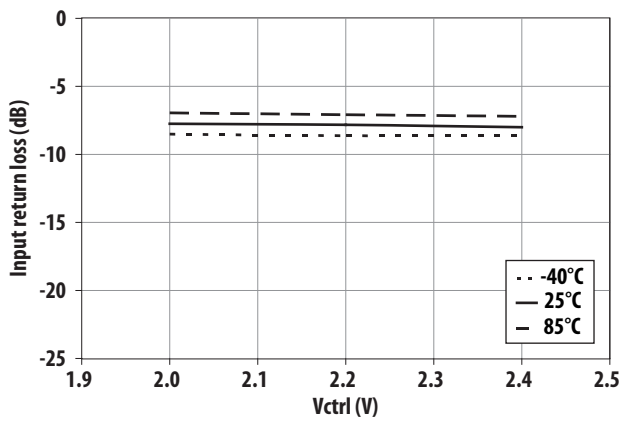

Figure 22. S11 vs Vctrl and temperature

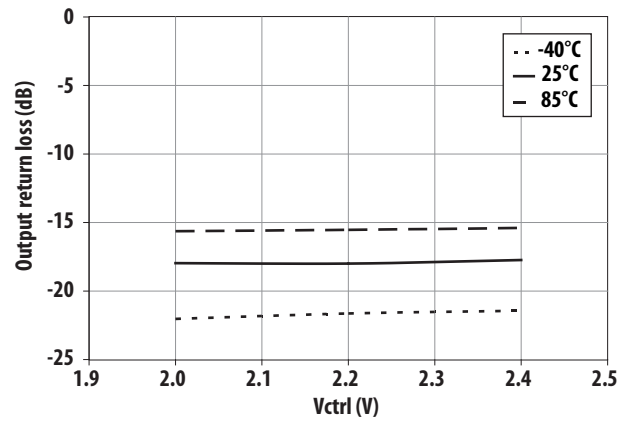

Figure 23. S22 vs Vctrl and temperature

ALM-1322 Typical Performance II

$T_A = +25^\circ\text{C}$, $V_{dd} = 5\text{V}$, $V_{ctrl} = 2.2\text{V}$, Frequency = 2GHz. Input Signal=CW unless stated otherwise.

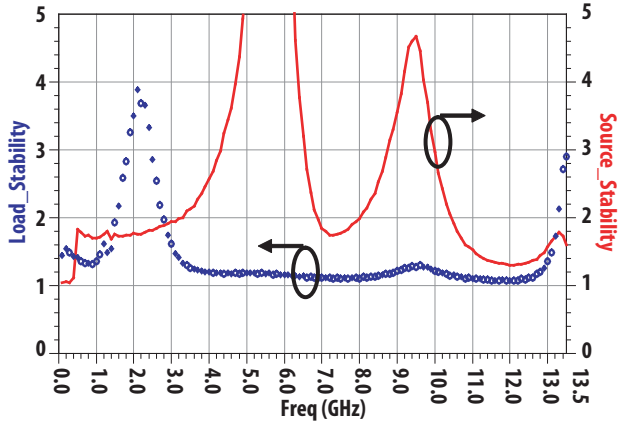
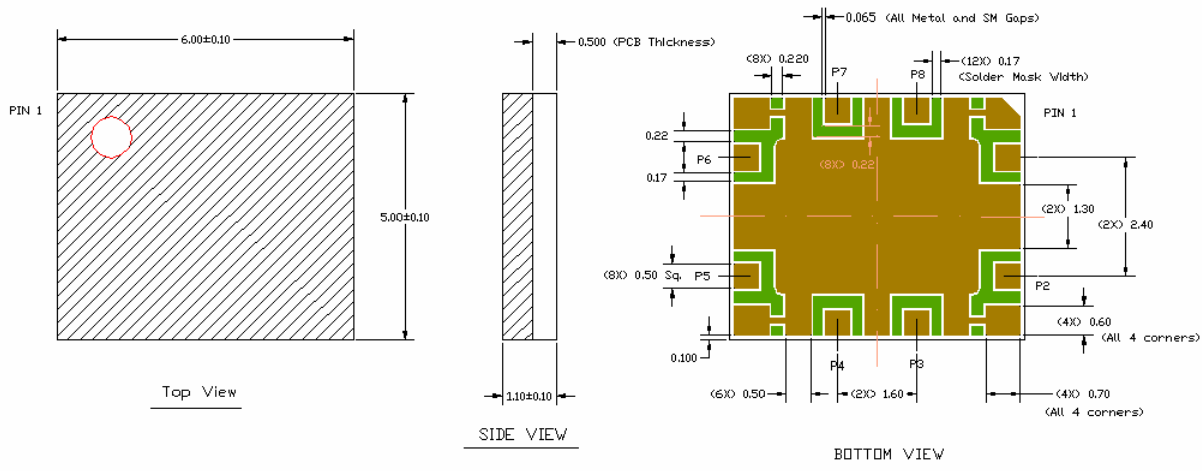

Figure 24. Stability over frequency

Package Dimensions



Device Orientation

