

**Sockets & Accessories, K10 Relays**

- Sockets for 2 pole relays with solder terminals
- Solder, PCB or screw terminal sockets
- Hold down springs
- Plates and brackets permit various mounting options



**Approvals**

UL E59244, CSA LR15734

Technical data of approved types on request

**Technical Data**

Socket contact material	Spring brass, tin plated
Socket body material	
Solder and PCB terminal models	Nylon
Screw terminal models	Glass-filled polyester
Maximum current	10A

**Ordering Code**

Product Code	Poles	Terminal type	Part number
27E488	2	solder terminals	2-1419106-0
27E489	2	PCB terminals	2-1419106-1

**Dimensions**

27E488 socket with solder terminals

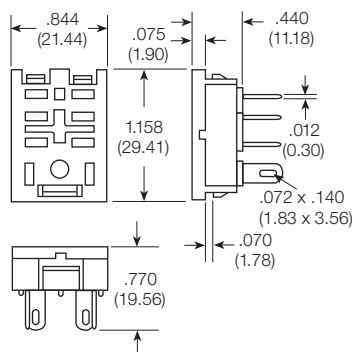

27E489 socket with printed circuit terminals

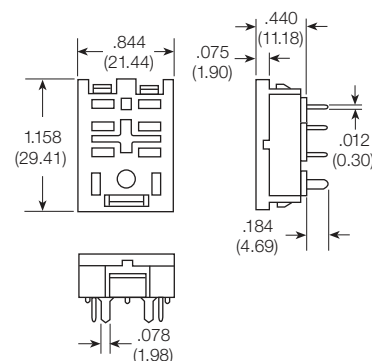

Recommended chassis cutout for solder terminal socket 27E488

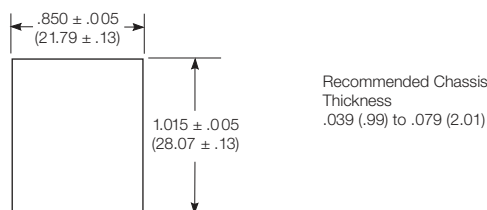

**Caution:** Printed circuit sockets are manufactured with "floating" (Loose) terminals. This permits them to align with holes in the circuit board and with the relay terminals. During the mounting and soldering of the socket, vertical float should be eliminated and the terminals seated on the board. (This may be accomplished by inserting a dummy relay in the socket.) Failure to eliminate float may cause fracture of the solder joint or separation of the copper conductor from the printed circuit board when a relay is inserted in the socket after soldering.

PC board layout (bottom view) for PCB terminal socket 27E489

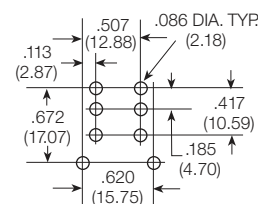

**Sockets & Accessories, K10 Relays (Continued)**

**Ordering Code**

Product Code	Terminal type	Mounting	Part number
27E895	screw terminals	DIN rail snap mount	2-1419106-7
27E487		Conventional	1-1419106-9

**Dimensions and terminal location**

Screw terminal, DIN rail, snap-mount socket 27E895

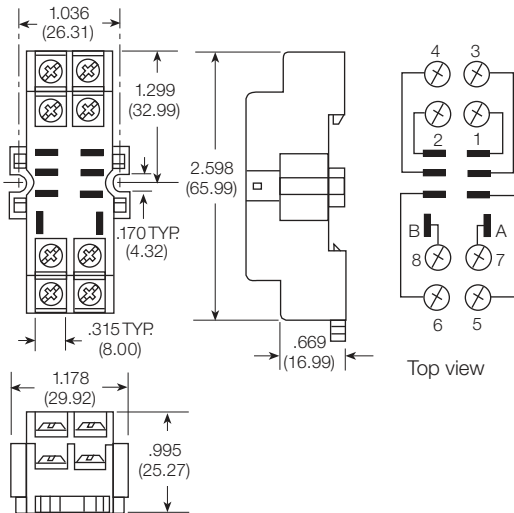

Screw terminal socket 27E487

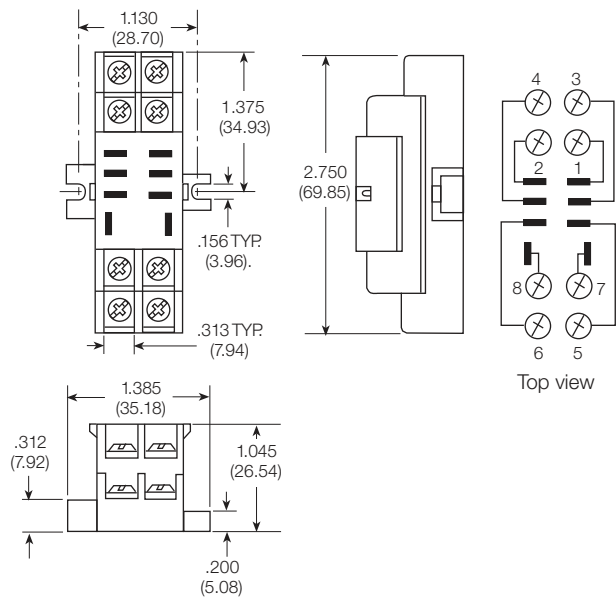

**Ordering Code**

Product Code	Description	Part number
20C217	Relay hold down spring - use with 27E488 and 27E489	1419111-2
20C426	Relay hold down spring - use with 27E487 and 27E895	5-1393159-1
37D633	Mounting strip - accepts eight 27E488	1419111-7
24A110	Mounting track	1419111-6
24A071	Steel mounting clip with #6-32 screw - use with 27E487 on 24A110 track	1419111-5
24A072	Plastic twist mounting clip - use with 27E487 on 24A110 track	5-1393159-4
40G432	Plastic insulator - use with 24A071 to make end clip for 24A110 track	9-1393159-5

All accessories must be ordered separately.

**Dimensions**

37D633 mounting strip

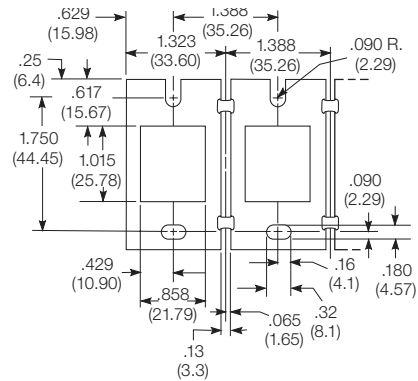

37D633 will mount eight solder terminal sockets in one length of aluminum strip measuring 10.97" x 2.25" x .062 (278.6 x 57.15 x 1.57)

24A110 DIN rail style mounting track

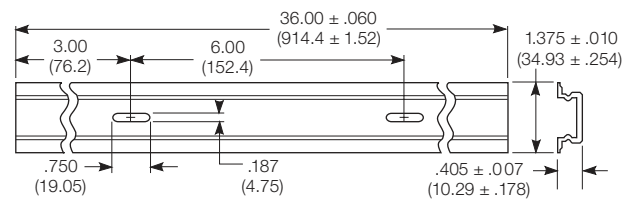

24A110 mounting track is designed to accept snap-mount sockets, as well as other P&B screw terminal sockets. Track is made of lightweight, sturdy extruded aluminum and is shipped in three-foot (914cm) lengths with mounting holes on six-inch (152mm) centers. Track can be cut to shorter lengths or used end-to-end.

Track and mounting accessories

