



NOTES:

1.MATERIAL:

HOUSING:Halogen Free PLASTIC,
HIGH TEMP, UL 94V-0
TERMINAL:COPPER ALLOY
TIN PLATED (t=0.12mm)

2.WIRE:AWG #28~32.

P/N LEGEND

50247-XXX H X X X-XXX

NO OF CKT

Polarization
0: None

MATERIAL
H: NYLON 66

XXX	PACKING	Halogen Free
001	BAG	HF

COLOR
0:White
1:BLACK

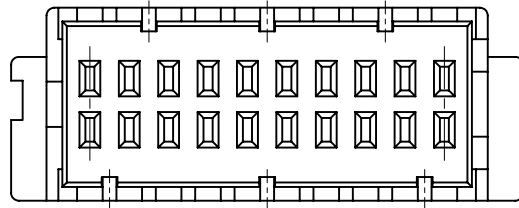
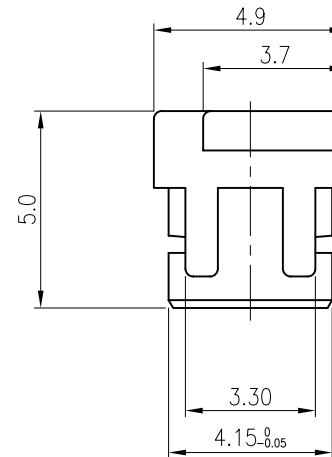
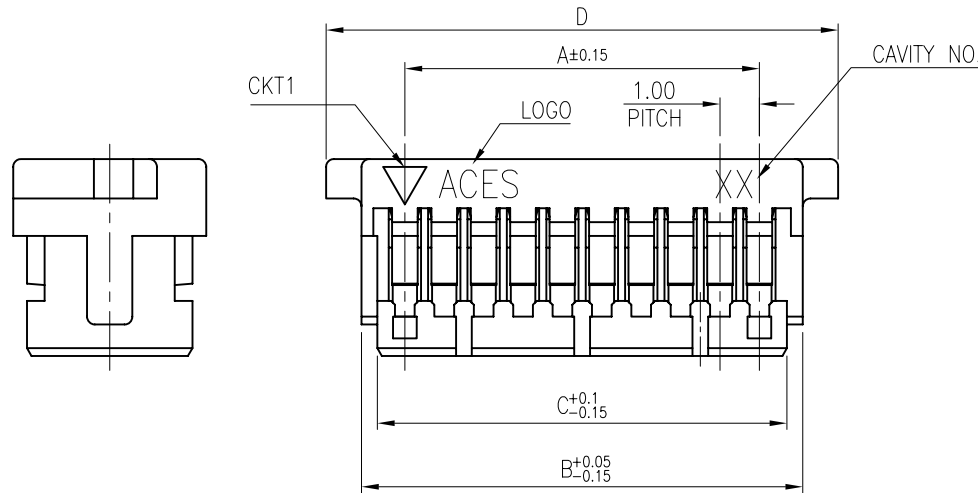
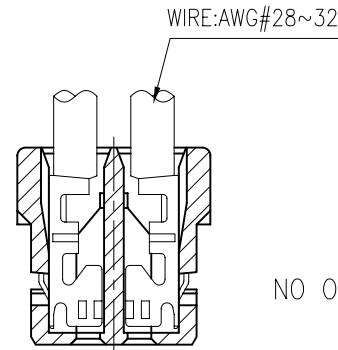
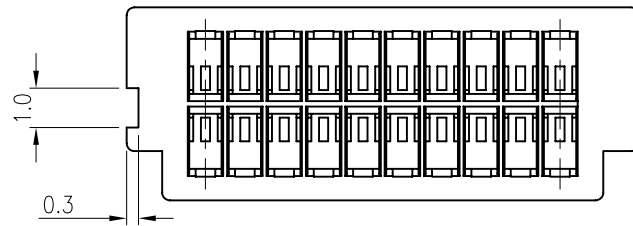

CKT	Dim A	Dim B	Dim C	Dim D
8	3.0	5.2	4.4	7.0
10	4.0	6.2	5.4	8.0
12	5.0	7.2	6.4	9.0
14	6.0	8.2	7.4	10.0
16	7.0	9.2	8.4	11.0
18	8.0	10.2	9.4	12.0
20	9.0	11.2	10.4	13.0
22	10.0	12.2	11.4	14.0
24	11.0	13.2	12.4	15.0
28	13.0	15.2	14.4	17.0
30	14.0	16.2	15.4	18.0
34	16.0	18.2	17.4	20.0
40	19.0	21.2	20.4	23.0
50	24.0	26.2	25.4	28.0
60	29.0	31.2	30.4	33.0

一般公差 TOLERANCES X ±0.5 .XX ±0.15 X ±0.25 .XXX ±0.1 ANGLES ±2°		宏致電子股份有限公司 Aces Electronic Co.,Ltd.	
檢驗尺寸標示 SYMBOLS INDICATE CLASSIFICATION DIMENSION MARK IS CRITICAL DIM. MARK IS MAJOR DIM.	品名 (TITLE) 1.0mm WTB D/R CONN. HOUSING 圖號 (DWG.NO) 50247-XXXHXXX-XXX	製圖 (DR) 16/08/11 LIYAQIN 審核 (CHKD) BRAVE 核准 (APPD) FRANK	張數 (SHEET) 1 OF 2 SIZE A4 REV E
表面處理 (FINISH)	比例 (SCALE) 5:1	單位 (UNITS) mm	

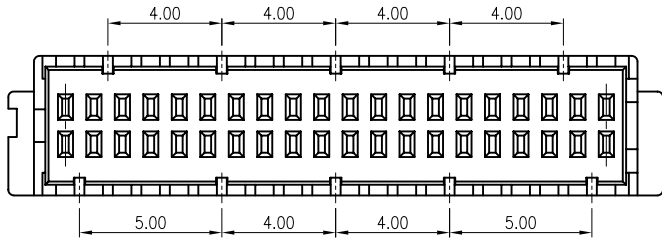

40 PIN

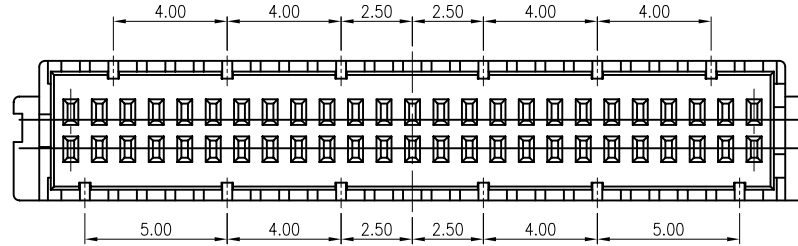

50 PIN

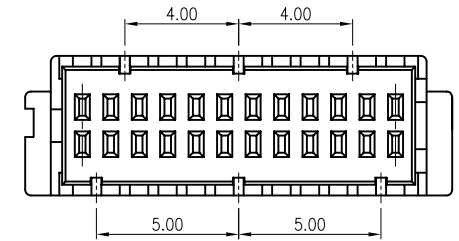

24 PIN

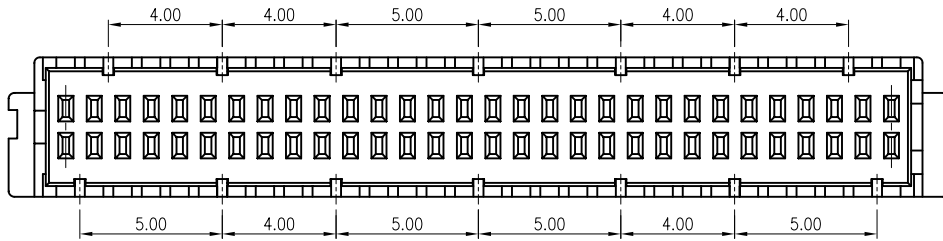

60 PIN

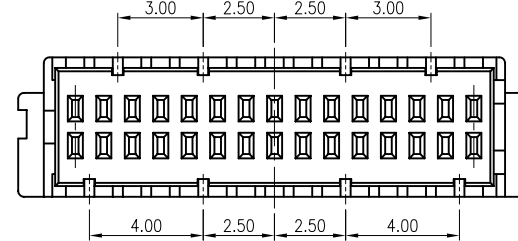

30 PIN

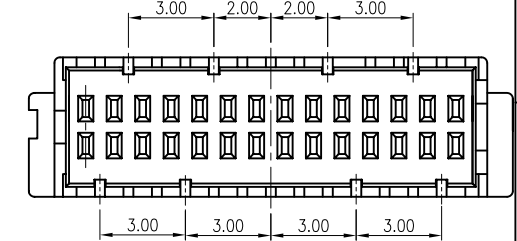

28 PIN

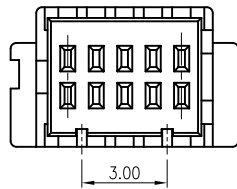

10 PIN

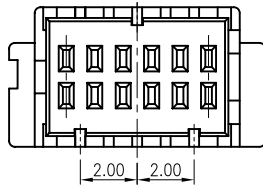

12 PIN

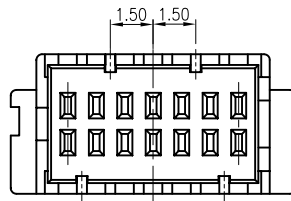

14 PIN

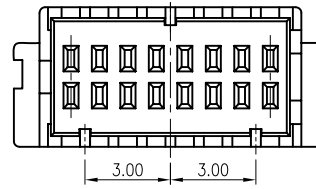

16 PIN

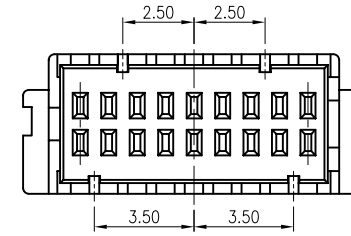

18 PIN

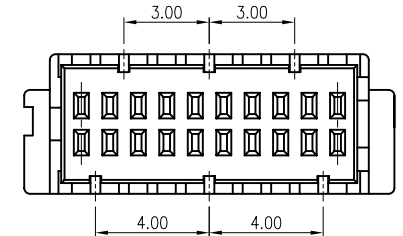

20 PIN

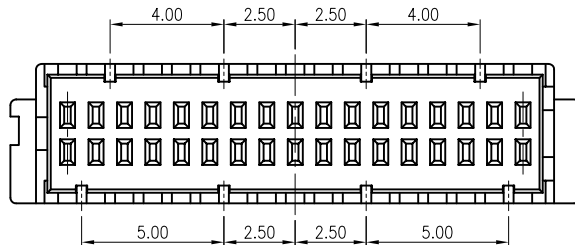

34 PIN

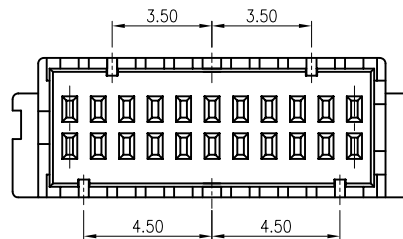

22 PIN

一般公差
TOLERANCES
X ±0.5 .XX ±0.15
X ±0.25 .XXX ±0.1
ANGLES ±2°

檢驗尺寸標示
SYMBOLS (M) (L) INDICATE
CLASSIFICATION DIMENSION

(M) MARK IS CRITICAL DIM.
(L) MARK IS MAJOR DIM.

表面處理 (FINISH)

宏致電子股份有限公司
Aces Electronic Co.,Ltd.

品名 (TITLE)
1.0mm WTB D/R CONN.
HOUSING

圖號 (DWG.NO)
50247-XXXHXXX-XXX

比例 (SCALE) 單位 (UNITS)
4:1 mm

製圖 (DR)
16/08/11 LIYAQIN

審核 (CHKD) BRAVE
核准 (APPD) FRANK

張數 (SHEET) 2 OF 2
SIZE A4
REV E

