



soberton inc.

EXCITER

Acoustic Product Specification

Product Number: E-4408



Release | Revision: A/2018

CONTENTS

This document contains the technical specifications for the exciter

Page 1

Specifications

Dimensions

Frequency Response

Specifications

Specification	Unit	E-4408
AC Impedance	Ω	8±15% at 1000Hz
Rated Input Power	Watt	5.0
Max Input Power	Watt	8.0
Resonant Frequency	Hz	500±20%
Frequency Range	Hz	F0~20.0KHz, average SPL±10dB
Output Sound Pressure Level	dB	86±3dB 1.0 Watt/10 cm, AVG. at 0.8, 1.0, 1.2, 1.5KHz
Operating Temperature	°C	-20°C ~ +50°C
Storage Temperature	°C	-40°C ~ +60°C
Dimension	mm	Ø 44.0 x H14.5
Distortion		3% maximum at 1000Hz, 5.0W
Polarity		Diaphragm shall move forward when a positive DC current is applied to the "+" or "Marked" terminal
Load Test		Audio Signal Generator at 6.32 Volt Total 48hrs and 20Hz ~ 20KHz resonant frequency
Abnormal Sound Test		Must be normal tested at 6.32 Volt sine wave

Dimensions

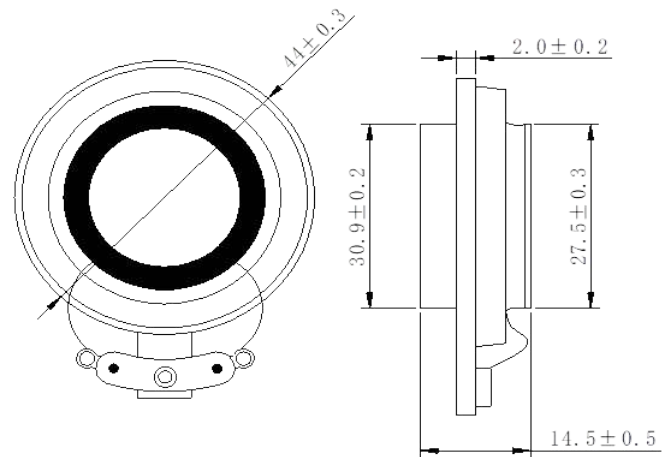

Unit: mm

Frequency Response

