

IFX25001

Low Dropout Voltage Regulator

Data Sheet

Rev. 1.02, 2010-05-20

Standard Power



1 Overview

Features

- Output Voltages: 2.5, 3.3, 5.0, 8.5, or 10.0 V
- Output Current up to 400 mA
- Low Current Consumption
- Wide Input Voltage Range up to 45V
- Low Dropout Voltage
- Output Current Limitation
- Reverse Polarity Protection
- Overtemperature Shutdown
- Wide Temperature Range, -40 °C to 125 °C
- Green Product (RoHS compliant)

Applications

- Manufacturing Automation
- Appliances
- HDTV Televisions
- Game Consoles
- Network Routers



PG-TO252-3

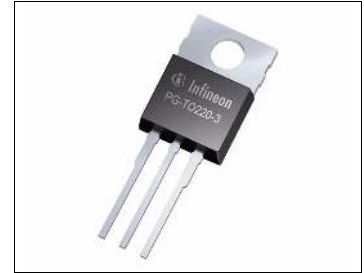

PG-TO220-3



PG-TO263-3



PG-SOT223-4

For automotive and transportation applications, please refer to the Infineon TLE and TLF voltage regulator series.

Description

The IFX25001 is a low dropout linear voltage regulator available in a 2.5, 3.3, 5.0, 8.5, or 10.0 V output. It is capable of supplying continuous output current up to 400 mA. A wide input voltage range up to 45V enables the IFX25001 to operate in a large variety of applications. The IFX25001 is also protected against overload, short circuit and overtemperature conditions.

Type	Package	Marking
IFX25001 ME V25	PG-SOT223-4	25001A
IFX25001 ME V33	PG-SOT223-4	25001B
IFX25001 TF V33	PG-TO252-3	2500133
IFX25001 TS V50	PG-TO220-3	25001V50
IFX25001TF V50	PG-TO252-3	2500150
IFX25001 TC V50	PG-TO263-3	25001V50
IFX25001 TS V85	PG-TO220-3	25001V85
IFX25001 TC V85	PG-TO263-3	25001V85
IFX25001 TS V10	PG-TO220-3	25001V10
IFX25001 TC V10	PG-TO263-3	25001V10

2 Block Diagram

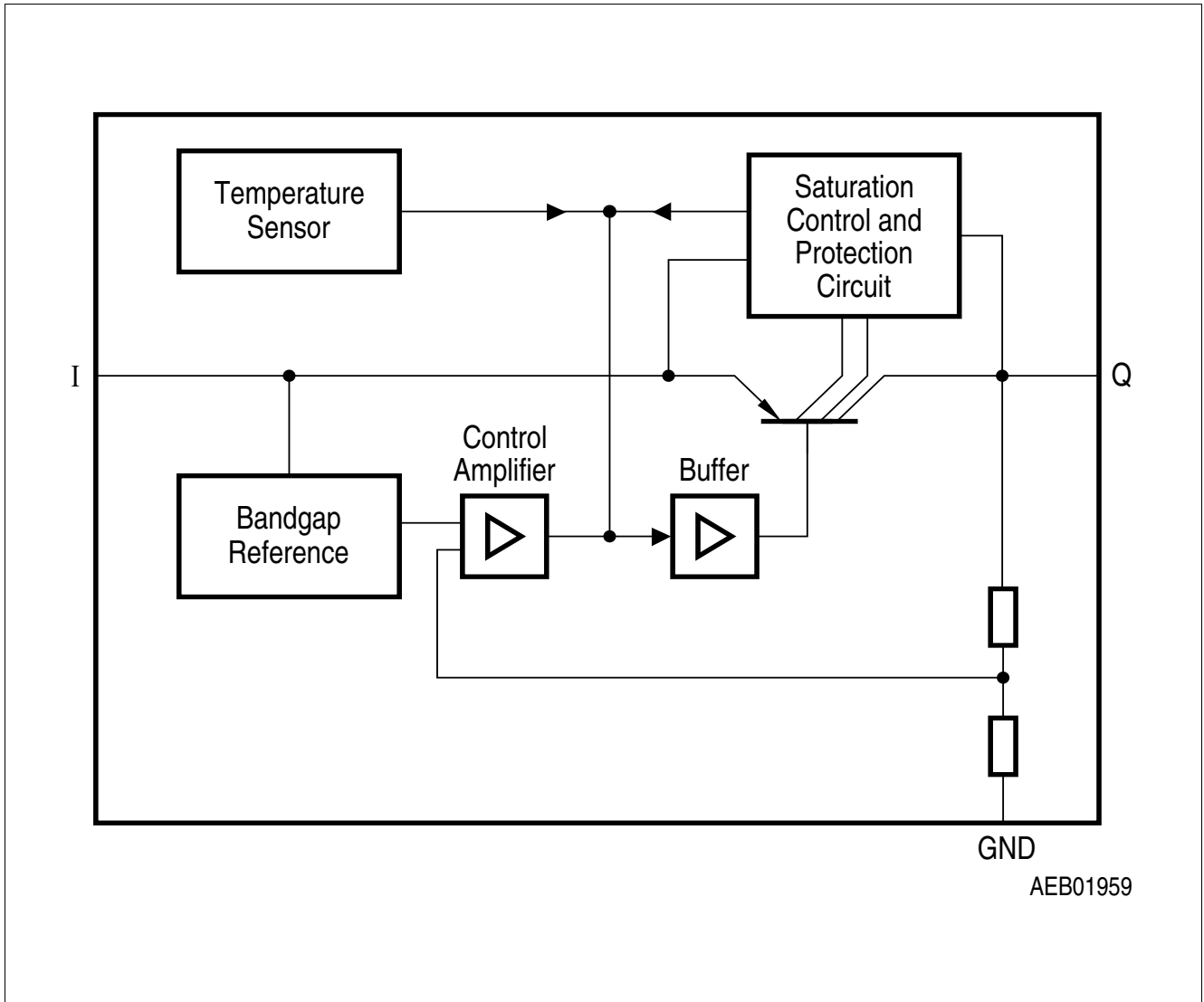

Figure 1 Block Diagram

3 Pin Configuration

3.1 Pin Assignment PG-SOT223-4, PG-TO252-3, PG-TO263-3, and PG-TO220-3

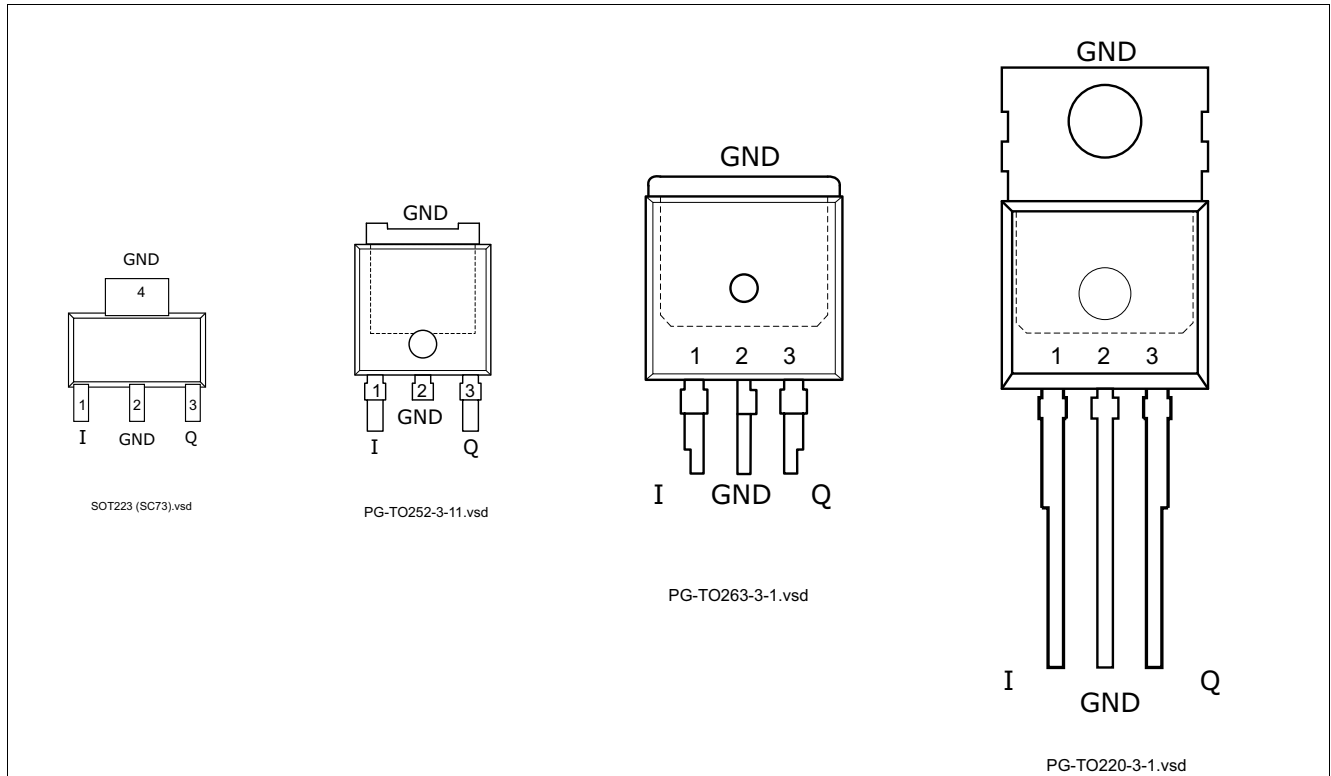

Figure 2 Pin Configuration (top view)

3.2 Pin Definitions and Functions PG-SOT223-4, PG-TO252-3, PG-TO263-3, and PG-TO220-3

Pin No.	Symbol	Function
1	I	Input connect Input pin to positive DC voltage source (e.g. battery); a small filter capacitor connected close to the Input pin and GND is recommended
2	GND	Ground internally connected to heat slug pin
3	Q	Output connect a capacitor close to the Output pin and GND according to the values specified in “Functional Range” on Page 5
4 / Heat Slug	GND	Heat Slug internally connected to GND pin; connect to heatsink to improve thermal performance

4 General Product Characteristics

4.1 Absolute Maximum Ratings

Absolute Maximum Ratings¹⁾

$T_j = -40\text{ °C}$ to 150 °C ; all voltages with respect to ground, (unless otherwise specified)

Pos.	Parameter	Symbol	Limit Values		Unit	Test Condition
			Min.	Max.		
Input I						
4.1.1	Voltage	V_I	-42	45	V	–
Output Q						
4.1.2	Voltage	V_Q	-1	40	V	–
Temperature						
4.1.3	Junction temperature	T_j	-40	150	°C	–
4.1.4	Storage temperature	T_{stg}	-50	150	°C	–

1) not subject to production test, specified by design

Note: Stresses above the ones listed here may cause permanent damage to the device. Exposure to absolute maximum rating conditions for extended periods may affect device reliability.

Note: Integrated protection functions are designed to prevent IC destruction under fault conditions described in the data sheet. Fault conditions are considered as "outside" normal operating range. Protection functions are not designed for continuous repetitive operation.

4.2 Functional Range

Pos.	Parameter	Symbol	Limit Values		Unit	Remarks
			Min.	Max.		
4.2.1	Input voltage	V_I	4.7	40	V	IFX25001 ME V25 IFX25001 ME V33 IFX25001 TF V33
4.2.2		V_I	5.5	40	V	IFX25001 TS V50 IFX25001TF V50 IFX25001 TC V50
4.2.3		V_I	9.0	40	V	IFX25001 TS V85 IFX25001 TC V85
4.2.4		V_I	10.5	40	V	IFX25001 TS V10 IFX25001 TC V10
4.2.5	Output Capacitor's Requirements for Stability	C_Q	22	–	µF	¹⁾
4.2.6		$ESR(C_Q)$	–	3	Ω	²⁾
4.2.7	Junction temperature	T_j	-40	125	°C	–

1) the minimum output capacitance requirement is applicable for a worst case capacitance tolerance of 30%

2) relevant ESR value at $f = 10\text{ kHz}$

Note: Within the functional or operating range, the IC operates as described in the circuit description. The electrical characteristics are specified within the conditions given in the Electrical Characteristics table.

4.3 Thermal Resistance

Note: This thermal data was generated in accordance with JEDEC JESD51 standards. For more information, go to www.jedec.org.

Pos.	Parameter	Symbol	Limit Values			Unit	Conditions
			Min.	Typ.	Max.		
PG-TO252-3							
4.3.1	Junction to Case ¹⁾	R_{thJC}	–	4	–	K/W	measured to heat slug
4.3.2	Junction to Ambient ¹⁾	R_{thJA}	–	27	–	K/W	²⁾
4.3.3		R_{thJA}	–	57	–	K/W	300 mm ² heatsink area ³⁾
4.3.4		R_{thJA}	–	42	–	K/W	600 mm ² heatsink area ³⁾
PG-TO263-3							
4.3.5	Junction to Case ¹⁾	R_{thJC}	–	4	–	K/W	measured to heat slug
4.3.6	Junction to Ambient ¹⁾	R_{thJA}	–	22	–	K/W	²⁾
4.3.7		R_{thJA}	–	42	–	K/W	300 mm ² heatsink area ³⁾
4.3.8		R_{thJA}	–	33	–	K/W	600 mm ² heatsink area ³⁾
PG-TO220-3							
4.3.9	Junction to Case ¹⁾	R_{thJC}	–	8	–	K/W	measured to exposed pad
PG-SOT223-4							
4.3.10	Junction to Case ¹⁾	R_{thJC}	–	25	–	K/W	measured to heat slug
4.3.11	Junction to Ambient ¹⁾	R_{thJA}	–	51	–	K/W	²⁾
4.3.12		R_{thJA}	–	75	–	K/W	300 mm ² heatsink area ³⁾
4.3.13		R_{thJA}	–	63	–	K/W	600 mm ² heatsink area ³⁾

1) Not subject to production test, specified by design.

2) Specified R_{thJA} value is according to Jedec JESD51-2,-5,-7 at natural convection on FR4 2s2p board; The Product (Chip+Package) was simulated on a 76.2 x 114.3 x 1.5 mm³ board with 2 inner copper layers (2 x 70µm Cu, 2 x 35µm Cu). Where applicable a thermal via array under the exposed pad contacted the first inner copper layer.

3) Specified R_{thJA} value is according to Jedec JESD 51-3 at natural convection on FR4 1s0p board; The Product (Chip+Package) was simulated on a 76.2 x 114.3 x 1.5 mm³ board with 1 copper layer (1 x 70µm Cu).

5 Electrical Characteristics

5.1 Electrical Characteristics Voltage Regulator

Electrical Characteristics
 $V_I = 13.5 \text{ V}$; $T_j = -40 \text{ }^\circ\text{C}$ to $125 \text{ }^\circ\text{C}$; all voltages with respect to ground (unless otherwise specified)

Pos.	Parameter	Symbol	Limit Values			Unit	Measuring Condition
			Min.	Typ.	Max.		
Output Q							
5.1.1	Output Voltage	V_Q	9.6	10.0	10.4	V	IFX25001 TS V10, IFX25001 TC V10 $5 \text{ mA} < I_Q < 400 \text{ mA}$ $11 \text{ V} < V_I < 28 \text{ V}$
5.1.1	Output Voltage	V_Q	8.16	8.5	8.84	V	IFX25001 TS V85, IFX25001 TC V85 $5 \text{ mA} < I_Q < 400 \text{ mA}$ $9.5 \text{ V} < V_I < 28 \text{ V}$
5.1.1	Output Voltage	V_Q	4.8	5.0	5.2	V	IFX25001 TS V50, IFX25001TF V50 IFX25001 TC V50 $5 \text{ mA} < I_Q < 400 \text{ mA}$ $6 \text{ V} < V_I < 28 \text{ V}$
5.1.2	Output Voltage	V_Q	3.17	3.3	3.44	V	IFX25001 ME V33, IFX25001 TF V33 $5 \text{ mA} < I_Q < 400 \text{ mA}$ $4.7 \text{ V} < V_I < 28 \text{ V}$
5.1.3	Output Voltage	V_Q	2.4	2.5	2.6	V	IFX25001 ME V25, $5 \text{ mA} < I_Q < 400 \text{ mA}$ $4.7 \text{ V} < V_I < 28 \text{ V}$
5.1.4	Dropout Voltage	V_{dr}	–	250	500	mV	IFX25001 TS V50, IFX25001TF V50, IFX25001 TC V50, IFX25001 TS V85, IFX25001 TC V85 IFX25001 TS V10, IFX25001 TC V10 $I_Q = 250 \text{ mA}$ $V_{dr} = V_I - V_Q^{1)}$
5.1.5	Dropout Voltage	V_{dr}	–	0.7	1.2	V	IFX25001 ME V33, IFX25001 TF V33; $I_Q = 300 \text{ mA}$ $V_{dr} = V_I - V_Q^{1)}$
5.1.6	Dropout Voltage	V_{dr}	–	1.0	2.0	V	IFX25001 ME V25, $I_Q = 300 \text{ mA}$ $V_{dr} = V_I - V_Q^{1)}$

Electrical Characteristics
Electrical Characteristics
 $V_I = 13.5 \text{ V}$; $T_j = -40 \text{ }^\circ\text{C}$ to $125 \text{ }^\circ\text{C}$; all voltages with respect to ground (unless otherwise specified)

Pos.	Parameter	Symbol	Limit Values			Unit	Measuring Condition
			Min.	Typ.	Max.		
5.1.7	Load Regulation	$\Delta V_{Q, lo}$	–	20	50	mV	IFX25001 TS V50, IFX25001TF V50, IFX25001 TC V50, $I_Q = 5 \text{ mA}$ to 400 mA $V_I = 6 \text{ V}$
5.1.8	Load Regulation	$\Delta V_{Q, lo}$	–	20	50	mV	IFX25001 TS V85, IFX25001 TC V85 IFX25001 TS V10, IFX25001 TC V10 $I_Q = 5 \text{ mA}$ to 400 mA
5.1.9	Load Regulation	$\Delta V_{Q, lo}$	–	40	70	mV	IFX25001 ME V33, IFX25001 TF V33, IFX25001 ME V25 $I_Q = 5 \text{ mA}$ to 300 mA $V_I = 6 \text{ V}$
5.1.10	Line Regulation	$\Delta V_{Q, li}$	–	10	25	mV	$V_I = 12 \text{ V}$ to 32 V $I_Q = 5 \text{ mA}$
5.1.11	Output Current Limitation	I_Q	400	600	1100	mA	¹⁾
5.1.12	Power Supply Ripple Rejection ²⁾	$PSRR$	–	60	–	dB	$f_r = 100 \text{ Hz}$; $V_r = 0.5 \text{ Vpp}$
5.1.13	Temperature Output Voltage Drift ²⁾	$\frac{dV_Q}{dT}$	–	0.5	–	mV/K	–
5.1.14	Overtemperature Shutdown Threshold	$T_{j, sd}$	151	–	200	$^\circ\text{C}$	T_j increasing ²⁾

Current Consumption

5.1.15	Quiescent Current $I_q = I_I - I_Q$	I_q	–	100	220	μA	$I_Q = 1 \text{ mA}$
5.1.16	Current Consumption	I_q	–	8	15	mA	$I_Q = 250 \text{ mA}$
5.1.17	$I_q = I_I - I_Q$	I_q	–	20	30	mA	$I_Q = 400 \text{ mA}$

1) Measured when the output voltage V_Q has dropped 100 mV from the nominal value obtained at $V_I = 13.5 \text{ V}$.

2) not subject to production test, specified by design

5.2 Typical Performance Characteristics Voltage Regulator (V50, V85, V10)

Dropout Voltage V_{dr} versus Output Current I_Q

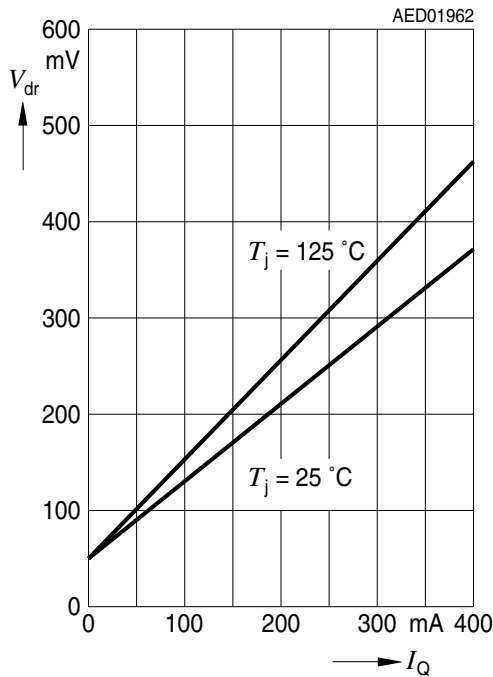

Output Current I_Q versus Input Voltage V_I

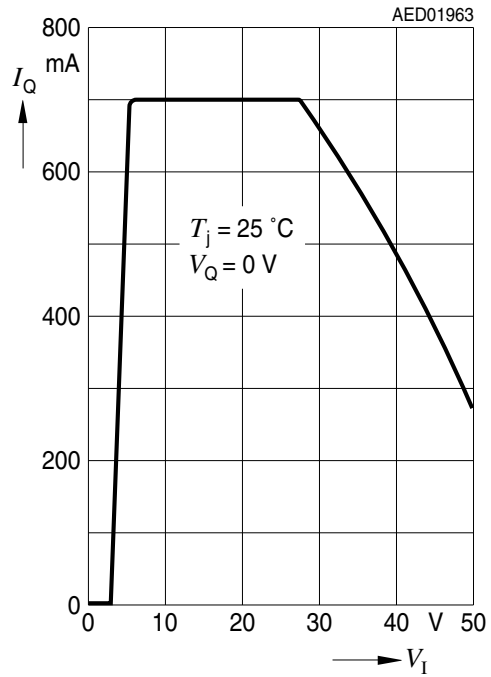

Current Consumption I_q versus Output Current I_Q (High Load)

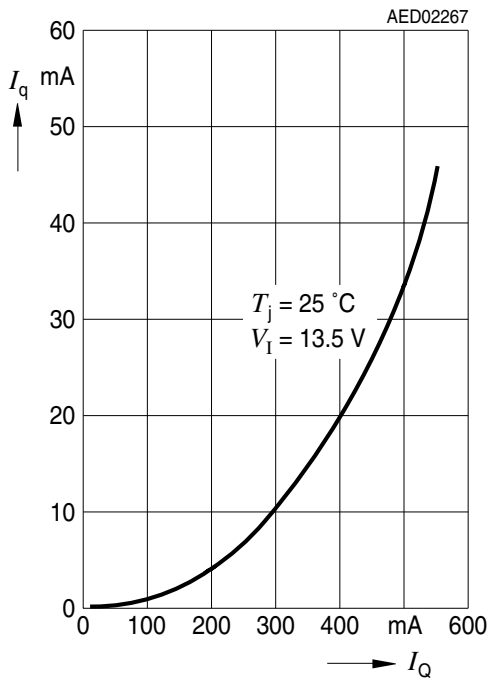

Current Consumption I_q versus Output Current I_Q (Low Load)

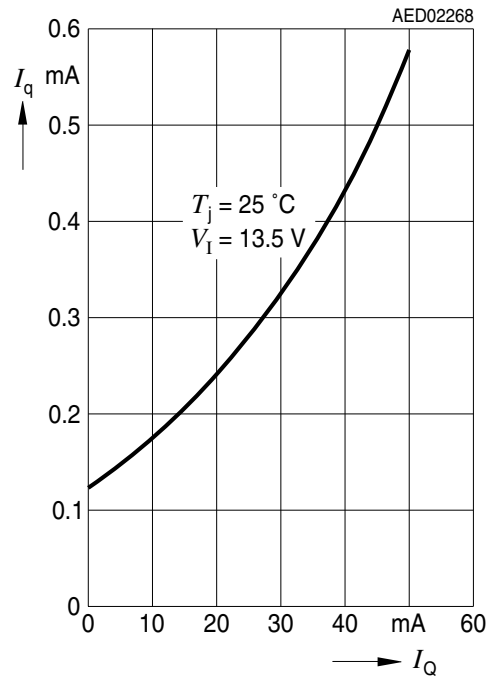

5.2.1 Typical Performance Characteristics Voltage Regulator (V50 Version)

Output Voltage V_Q versus Junction Temperature T_j

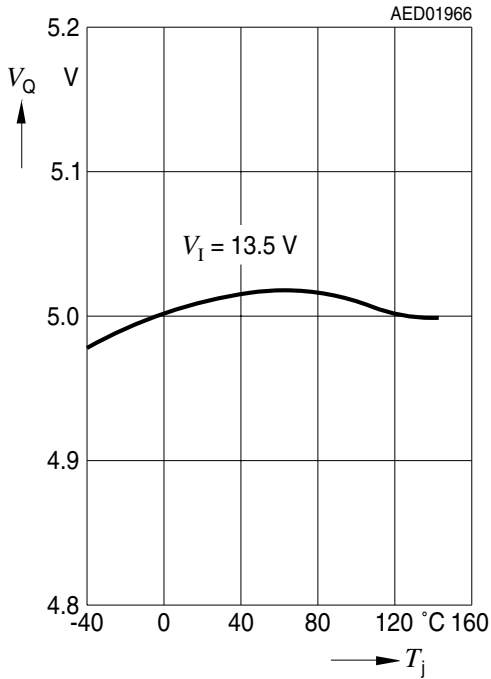

Current Consumption I_q versus Input Voltage V_I

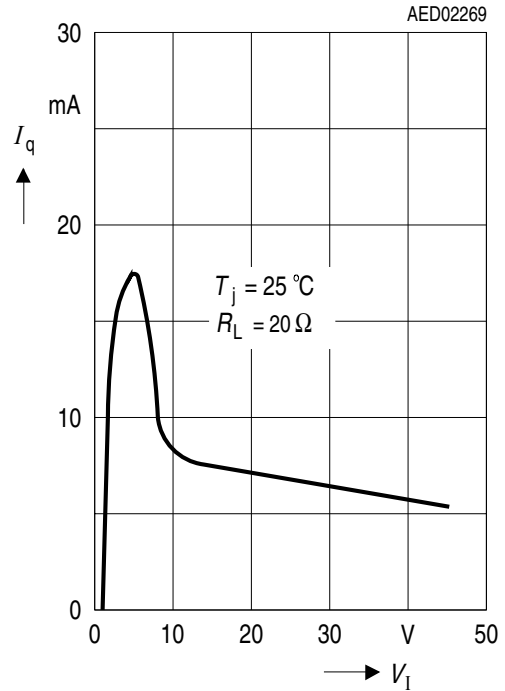

Output Voltage V_Q versus Input Voltage V_I

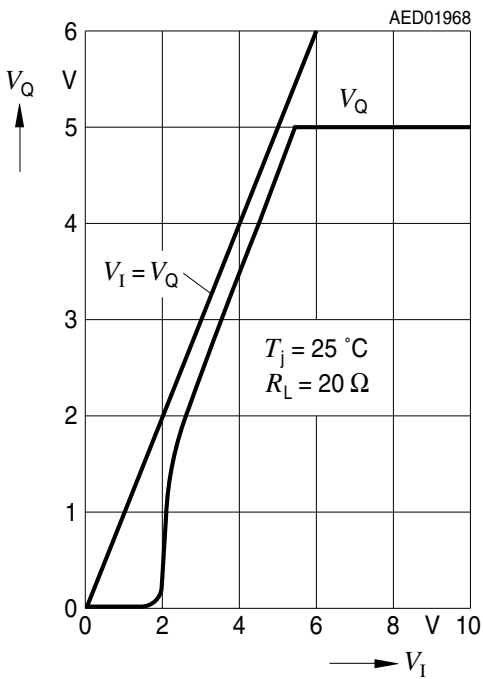

Input Current I_I versus Input Voltage V_I

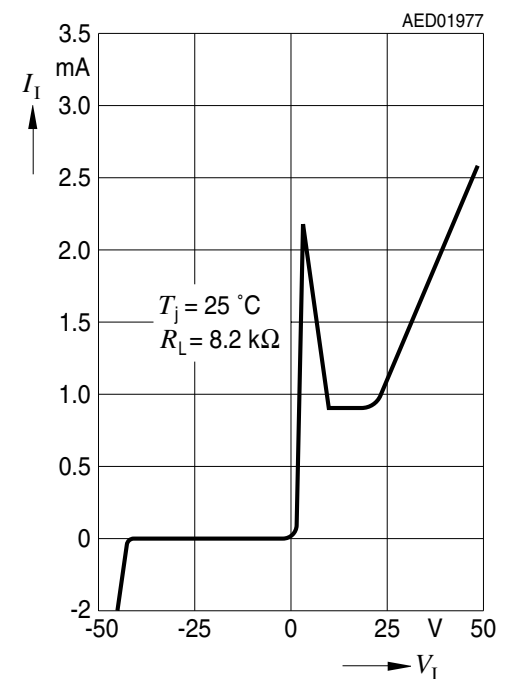

5.2.2 Typical Performance Characteristics Voltage Regulator (V85 Version)

Output Voltage V_Q versus Junction Temperature T_j

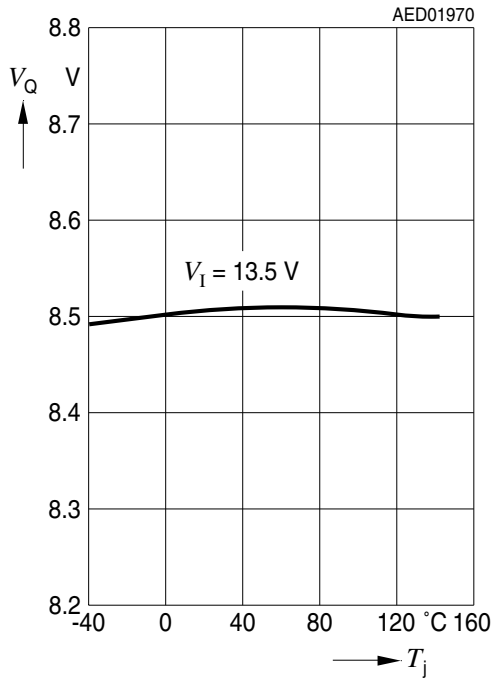

Current Consumption I_q versus Input Voltage V_I

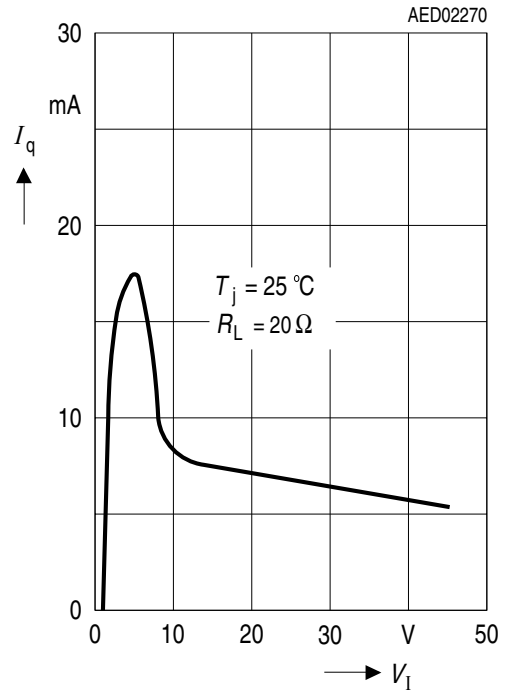

Output Voltage V_Q versus Input Voltage V_I

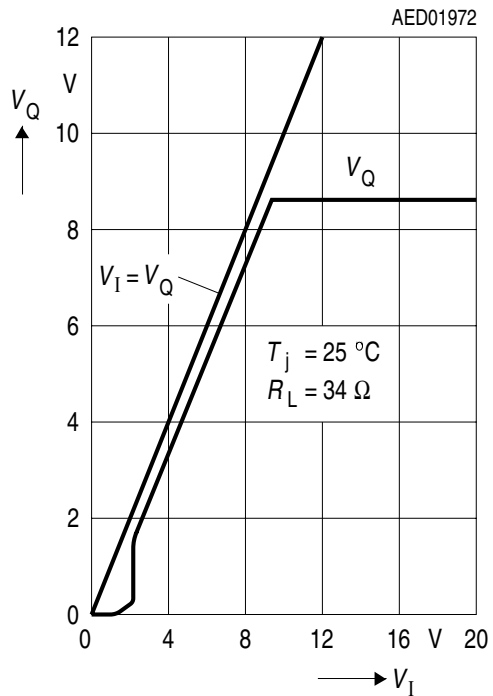

Input Current I_I versus Input Voltage V_I

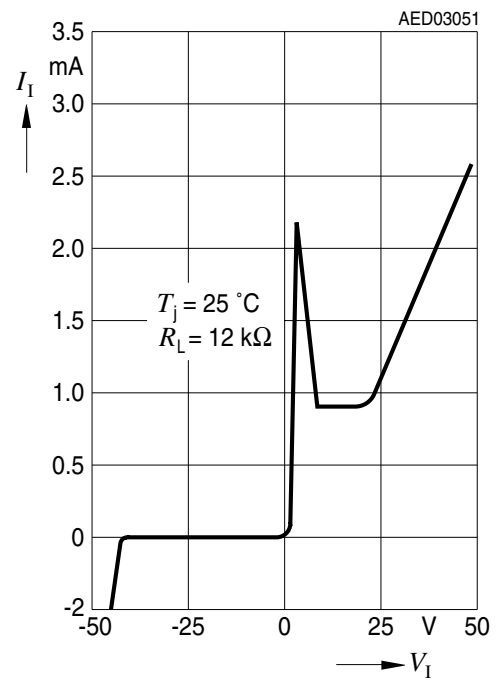

5.2.3 Typical Performance Characteristics Voltage Regulator (V10 Version)

Output Voltage V_Q versus Junction Temperature T_j

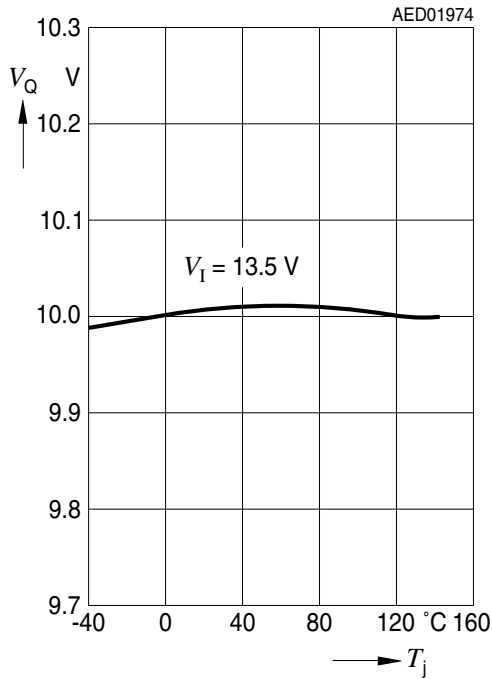

Current Consumption I_q versus Input Voltage V_I

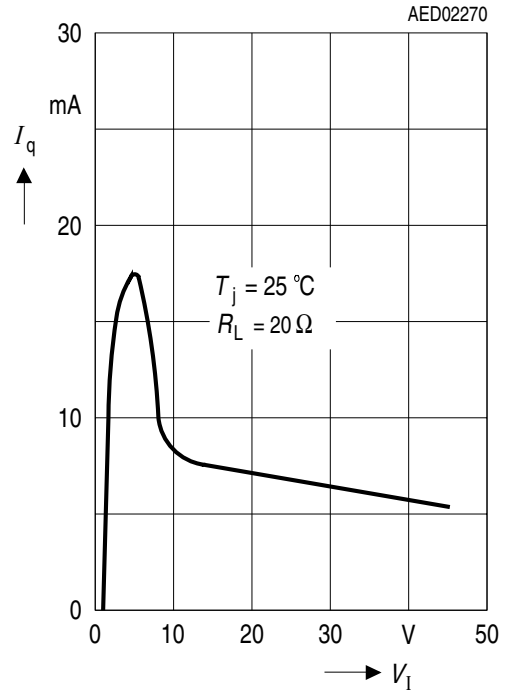

Output Voltage V_Q versus Input Voltage V_I

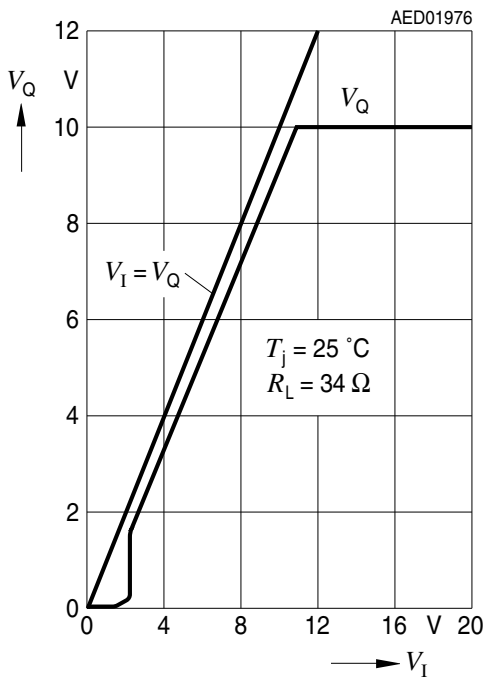

Input Current I_I versus Input Voltage V_I

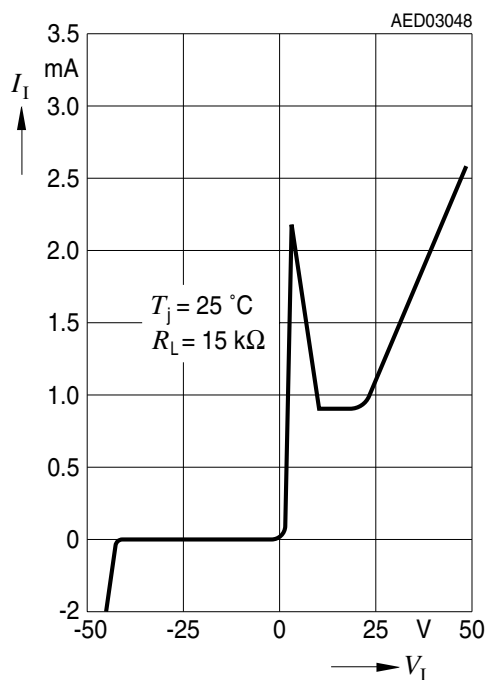

5.2.4 Typical Performance Characteristics Voltage Regulator (V33 and V25 Version)

Output Voltage V_Q versus Junction Temperature T_j (V33 Version)

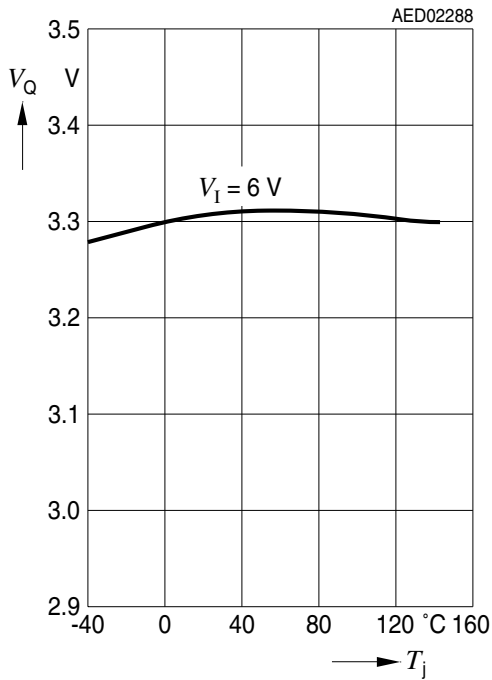

Output Voltage V_Q versus Junction Temperature T_j (V25 Version)

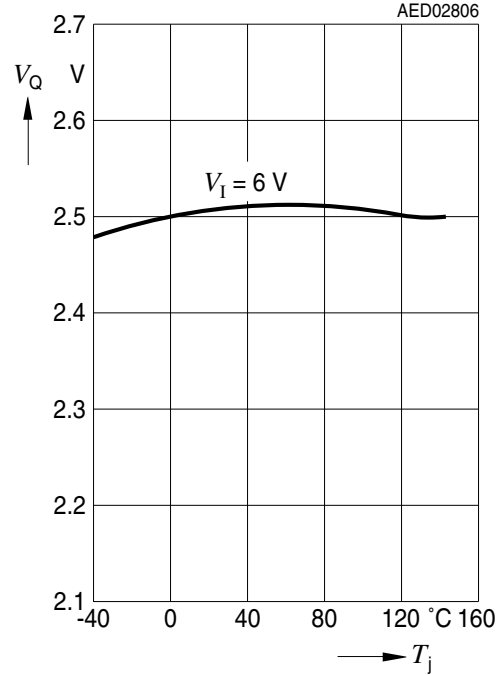

Input Current I_I versus Input Voltage V_I (V33 Version)

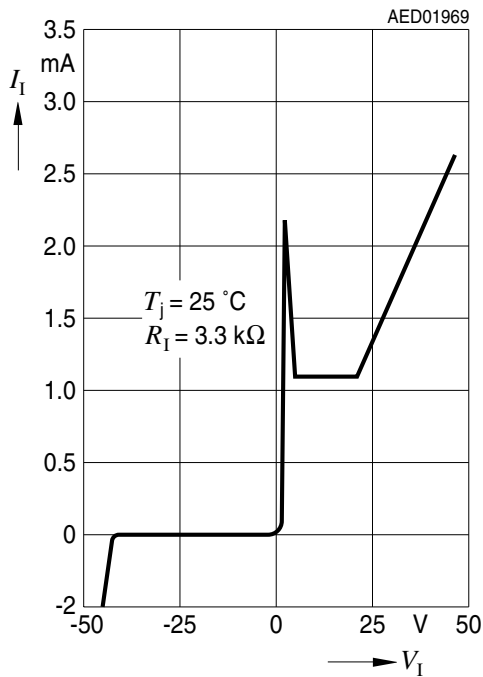

Input Current I_I versus Input Voltage V_I (V25 Version)

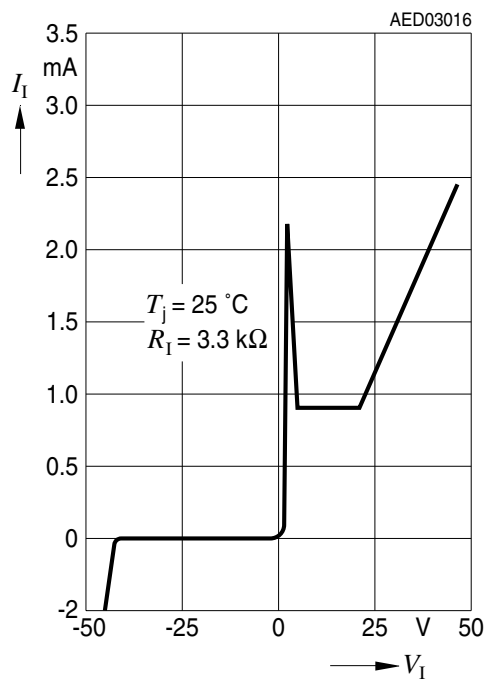

5.2.5 Typical Performance Characteristics Voltage Regulator (V33 and V25 Version)

Current Consumption I_q versus Output Current I_Q (Low Load)

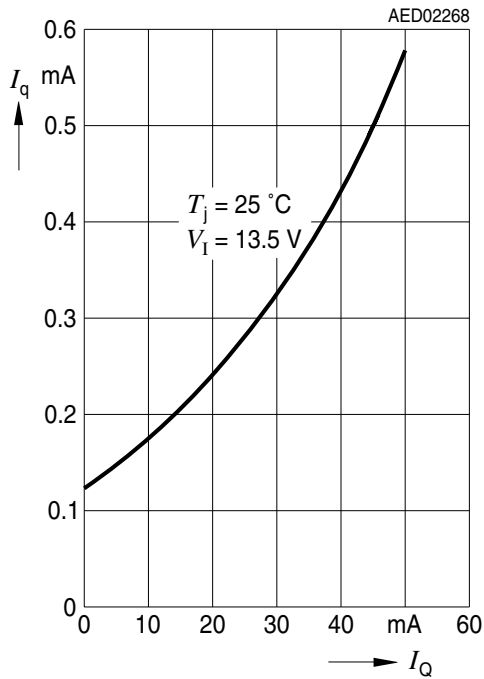

Current Consumption I_q versus Output Current I_Q (High Load)

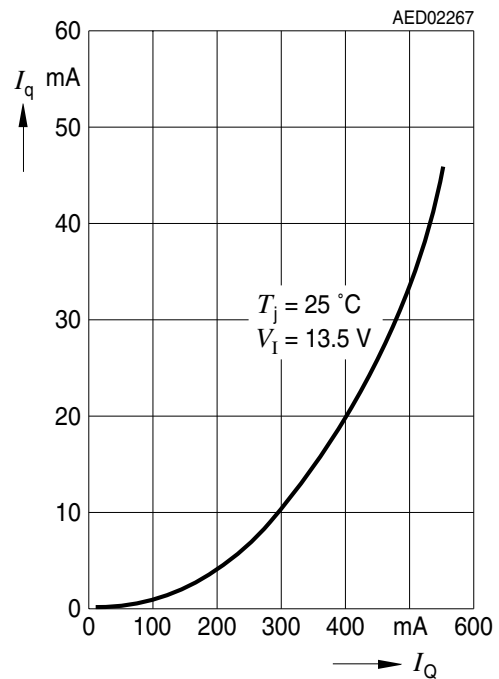

Output Current I_Q versus Input Voltage V_I

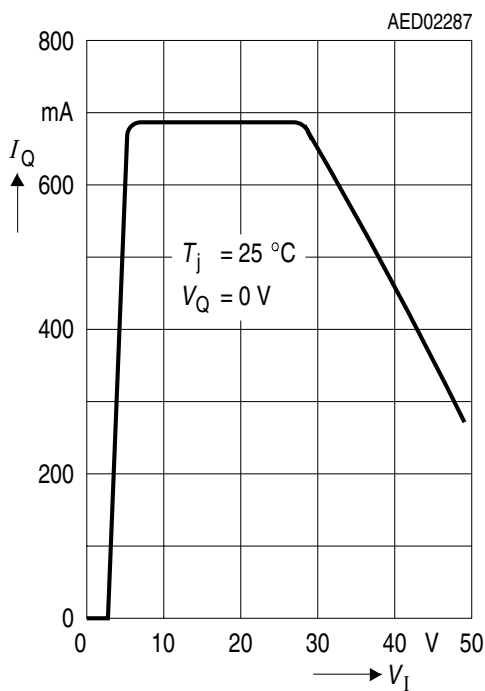

Region of Stability For Output Capacitor, $C_Q = 10 \mu\text{F}$

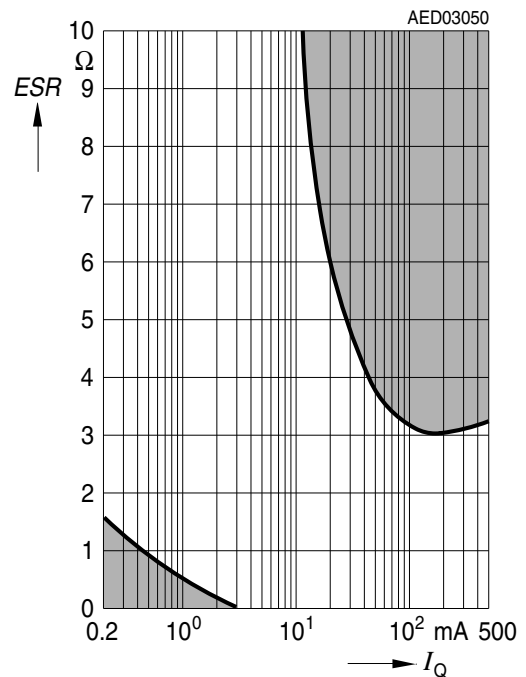

6 Package Outlines

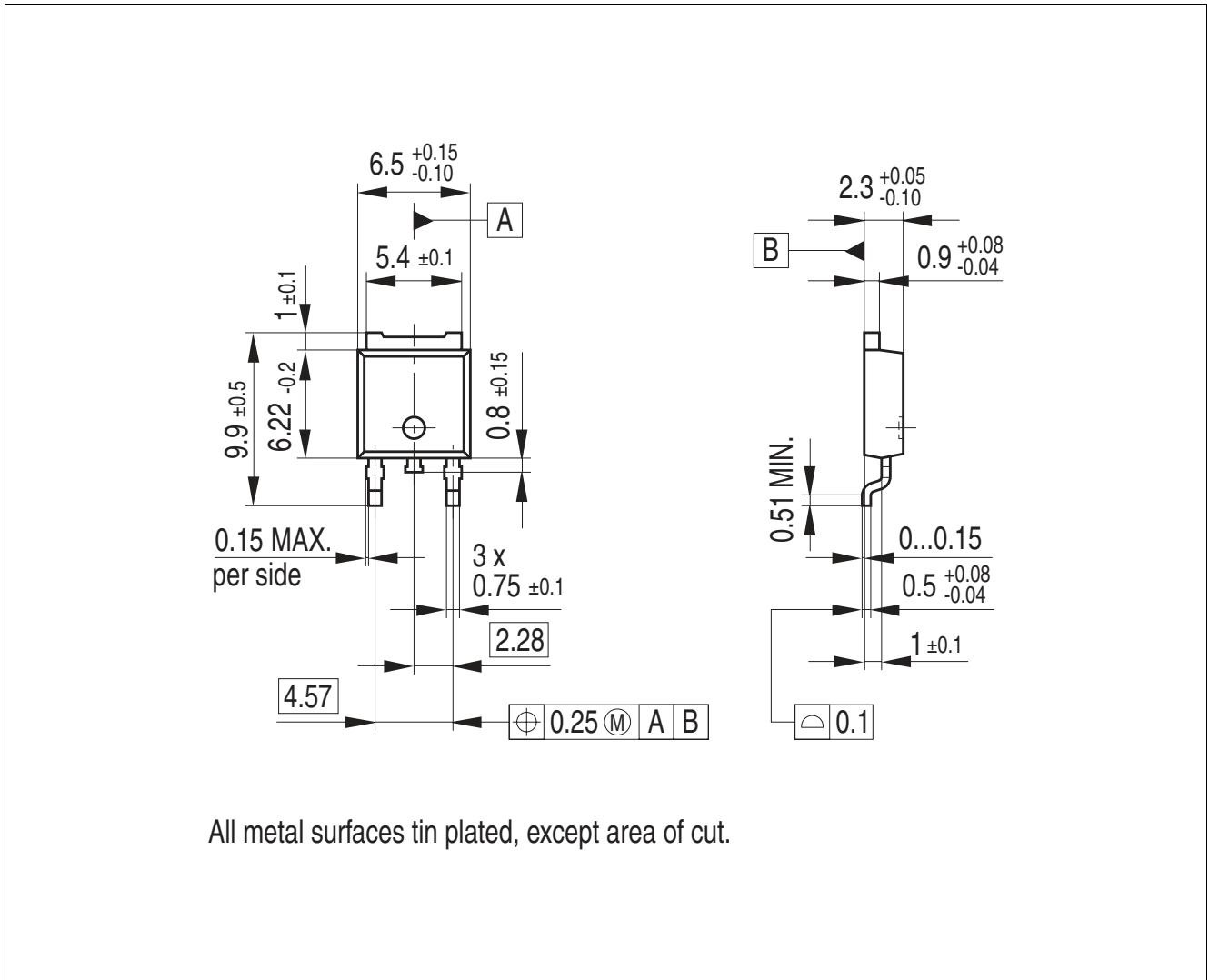

Figure 3 PG-TO252-3

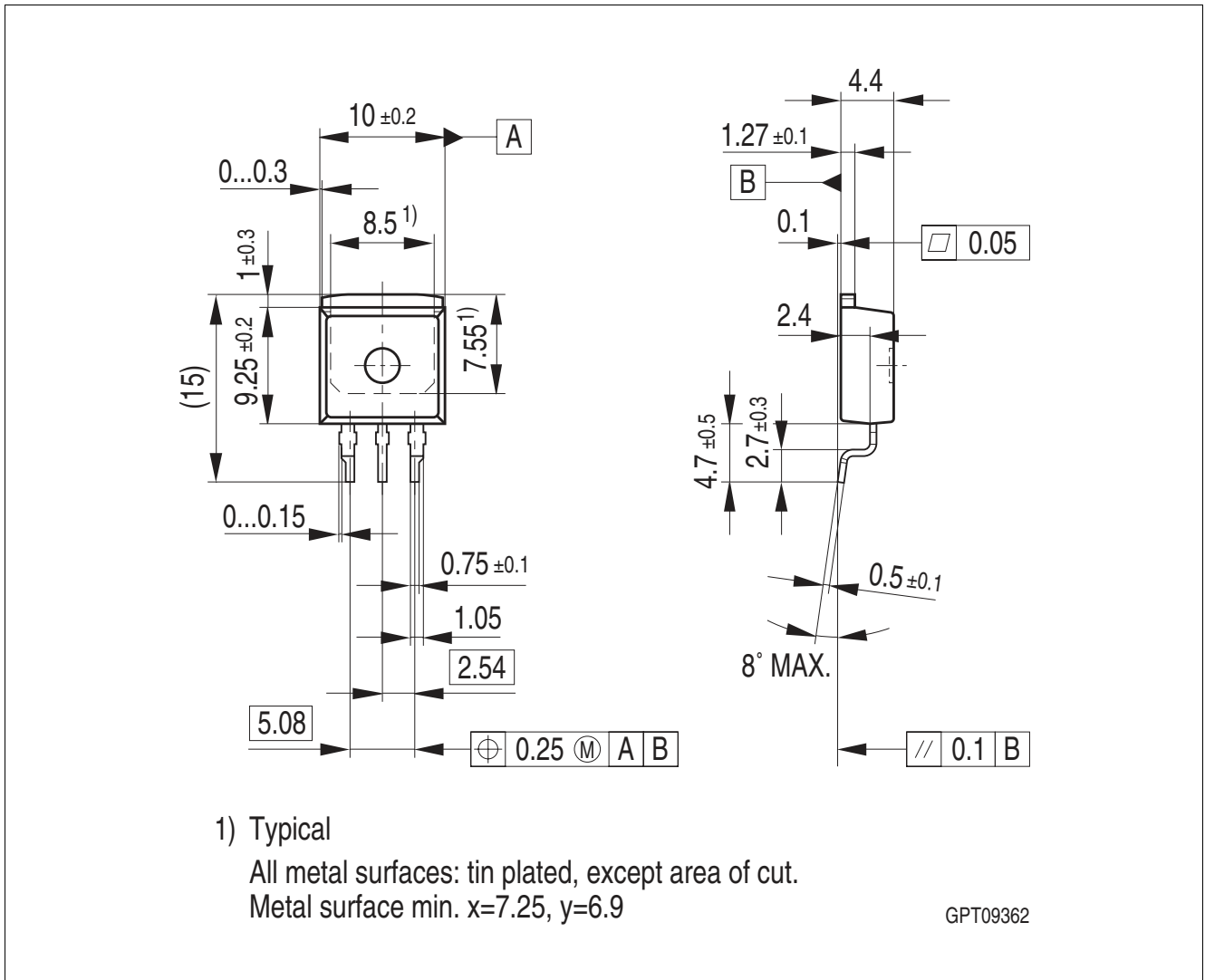

Figure 4 PG-TO263-3

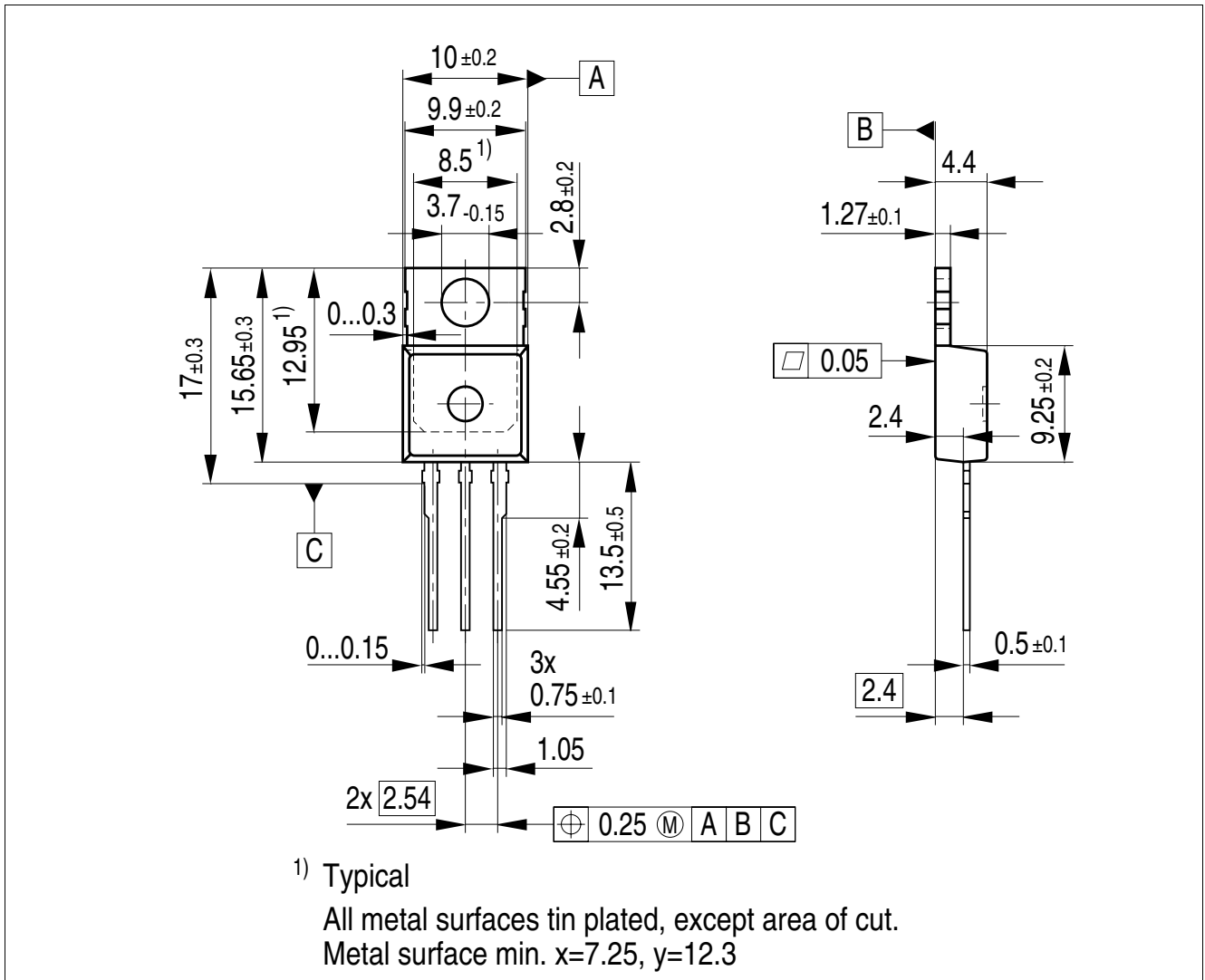

Figure 5 PG-TO220-3

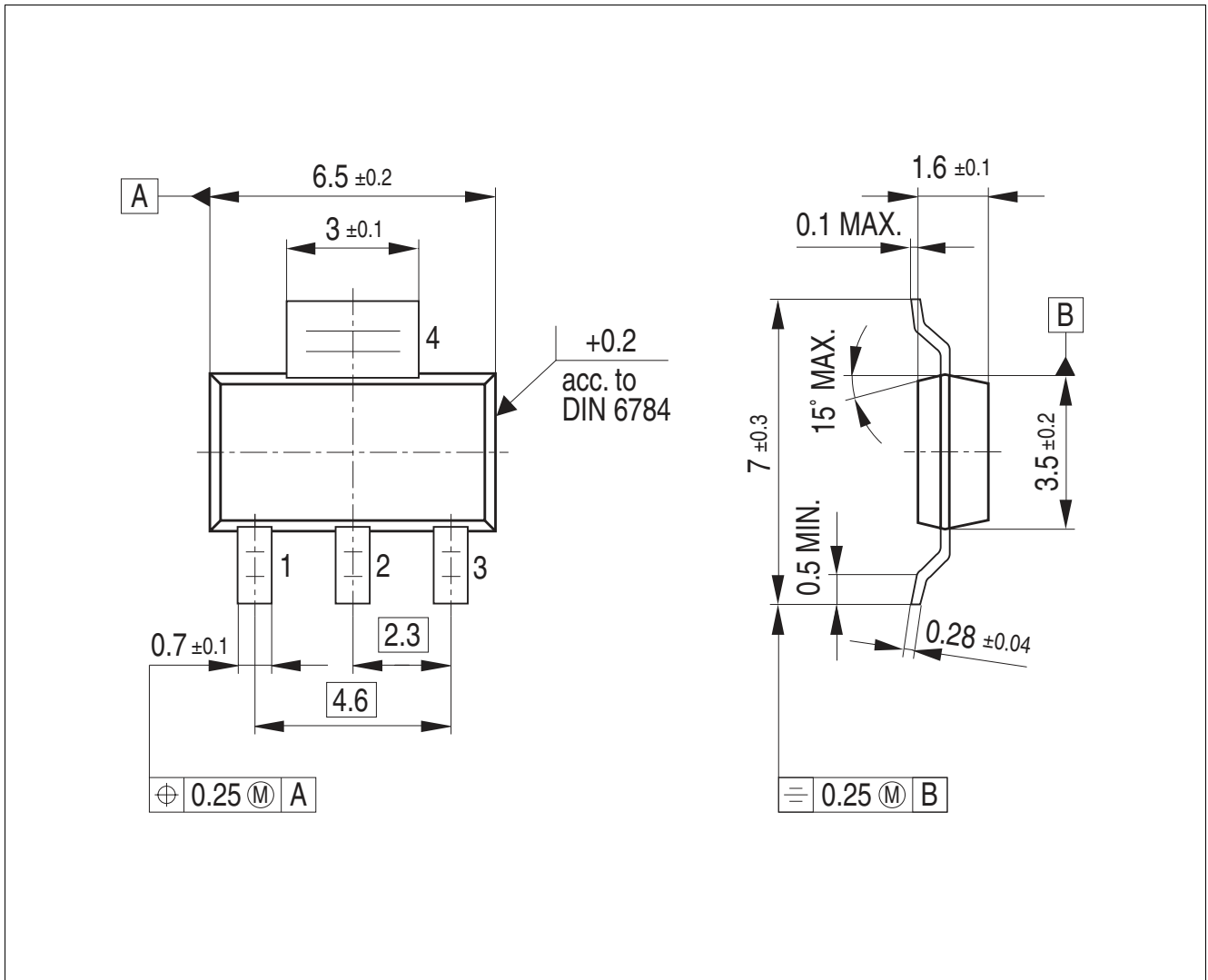

Figure 6 PG-SOT223-4

Green Product (RoHS compliant)

To meet the world-wide customer requirements for environmentally friendly products and to be compliant with government regulations the device is available as a green product. Green products are RoHS-Compliant (i.e. Pb-free finish on leads and suitable for Pb-free soldering according to IPC/JEDEC J-STD-020).

For further information on packages, please visit our website:
<http://www.infineon.com/packages>.

Dimensions in mm

7 Revision History

Revision	Date	Changes
1.02	2009-05-20	Editorial change (fig. 2)
1.01	2009-10-02	Coverpage changed Overview page: Inserted reference statement to TLE/TLF series.
1.0	2009-04-28	Initial Release

Edition 2010-05-20

**Published by
Infineon Technologies AG
81726 Munich, Germany**

**© 2010 Infineon Technologies AG
All Rights Reserved.**

Legal Disclaimer

The information given in this document shall in no event be regarded as a guarantee of conditions or characteristics. With respect to any examples or hints given herein, any typical values stated herein and/or any information regarding the application of the device, Infineon Technologies hereby disclaims any and all warranties and liabilities of any kind, including without limitation, warranties of non-infringement of intellectual property rights of any third party.

Information

For further information on technology, delivery terms and conditions and prices, please contact the nearest Infineon Technologies Office (www.infineon.com).

Warnings

Due to technical requirements, components may contain dangerous substances. For information on the types in question, please contact the nearest Infineon Technologies Office.

Infineon Technologies components may be used in life-support devices or systems only with the express written approval of Infineon Technologies, if a failure of such components can reasonably be expected to cause the failure of that life-support device or system or to affect the safety or effectiveness of that device or system. Life support devices or systems are intended to be implanted in the human body or to support and/or maintain and sustain and/or protect human life. If they fail, it is reasonable to assume that the health of the user or other persons may be endangered.