

Molded SMD Power Inductor



ASPIAIG-F4020 Series

Request Samples



Check Inventory



4.4 x 4.4 x 1.9 mm

RoHS/RoHS II Compliant

MSL Level = 1

Features

- PPAP ready and supported
- TS16949 certified production lines
- AEC-Q200 qualified
- Excellent current capacity – up to 33A
- Exceptionally low DCR – only 2.4mΩ
- Soft saturation
- Low profile for compact designs
- Shielded constructions for low EMI

Applications

- Automotive grade 1 and electric vehicles
- ADAS and body electronics
- Infotainment systems
- Lighting
- Motor control
- Solar inverters and solar power
- DC/DC converters in distributed power systems
- Battery powered device

Electrical Specifications

Part Number	Inductance	Tolerance	DC Resistance	Saturation Current	Temperature Rise Current
	0.1MHz/0.1V		Max	Max	Max
Units	μH	%	mΩ	A	A
Symbol	L	M	DCR	Isat	Irms
ASPIAIG-F4020-R10	0.10	20%	2.42	33.0	18.0
ASPIAIG-F4020-R22	0.22	20%	4.60	18.8	16.8
ASPIAIG-F4020-R36	0.36	20%	6.30	15.0	14.5
ASPIAIG-F4020-R40	0.40	20%	7.73	13.5	14.0
ASPIAIG-F4020-R56	0.56	20%	9.30	12.6	12.0
ASPIAIG-F4020-R60	0.60	20%	9.52	12.3	11.7
ASPIAIG-F4020-R72	0.72	20%	11.60	10.6	10.5
ASPIAIG-F4020-1R0	1.00	20%	14.60	8.8	9.6
ASPIAIG-F4020-1R2	1.20	20%	17.90	7.8	9.0
ASPIAIG-F4020-1R5	1.50	20%	23.50	7.4	7.6
ASPIAIG-F4020-1R8	1.80	20%	28.00	7.0	7.0
ASPIAIG-F4020-2R2	2.20	20%	38.70	6.0	5.6

Test Conditions

Isat: Current at which the inductance drops 30% from its initial value

Irms: Current at which the temperature rises (ΔT , approximate 40 °C) from 20°C ambient

Operating Temperature: -40°C ~ +125°C (including self-temperature rise)

Storage Condition: -10°C ~ +40°C and R.H. 60% max

ASPIAIG-F4020 Series is **RoHS Compliant and Pb free**

ASPIAIG-F4020 Series is **AEC-Q200 Grade 1 qualified (-40°C ~ +125°C ambient)**

Operating Voltage: 15V (1.5μH and above), 40V (1.2μH and below)

MSL level: 1



5101 Hidden Creek Ln Spicewood TX 78669
Phone: 512-371-6159 | Fax: 512-351-8858
For terms and conditions of sales, please visit:
www.abracon.com

REVISION A : 11/10/2021

ABRACON IS
ISO9001-2015
CERTIFIED

Molded SMD Power Inductor



ASPIAIG-F4020 Series

Request Samples



Check Inventory



4.4 x 4.4 x 1.9 mm
 RoHS/RoHS II Compliant
 MSL Level = 1

ASPIAIG-F4020-R10

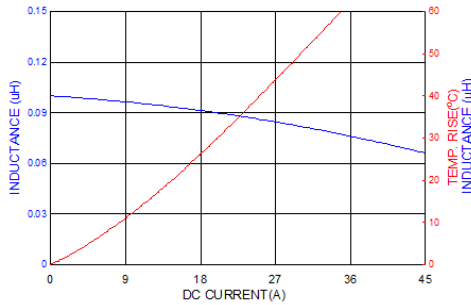

ASPIAIG-F4020-R22

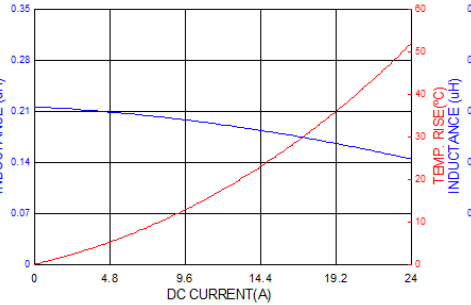

ASPIAIG-F4020-R36

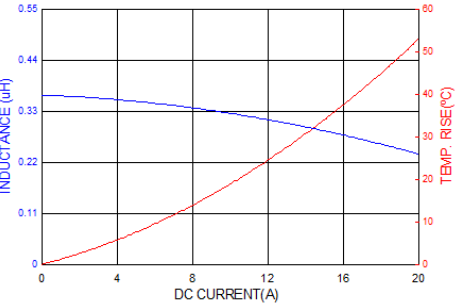

ASPIAIG-F4020-R40

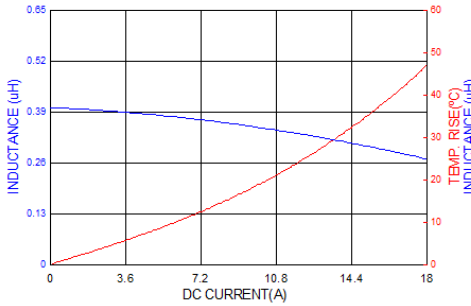

ASPIAIG-F4020-R56

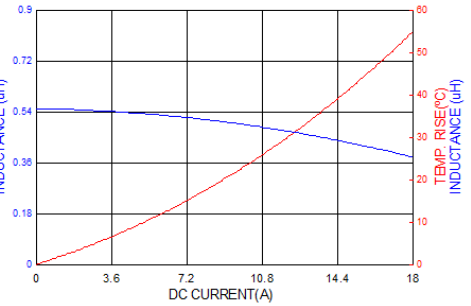

ASPIAIG-F4020-R60

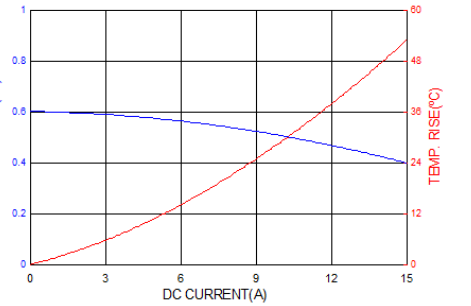

ASPIAIG-F4020-R72

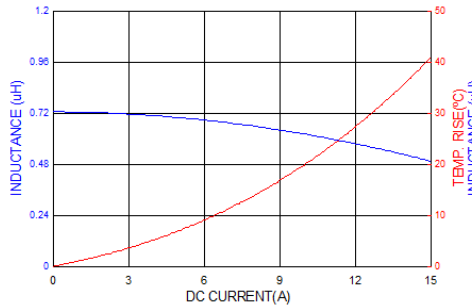

ASPIAIG-F4020-1R0

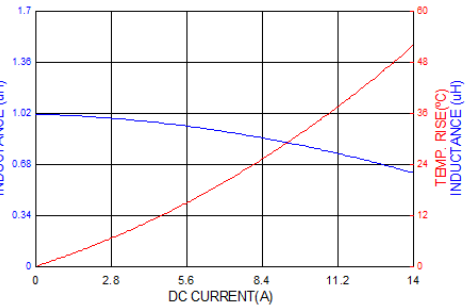

ASPIAIG-F4020-1R2

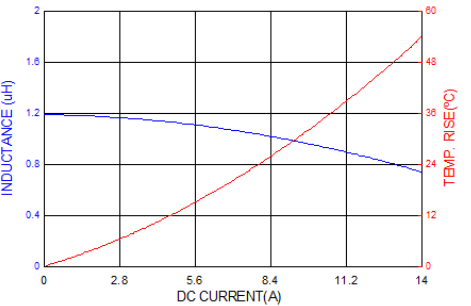

ASPIAIG-F4020-1R5

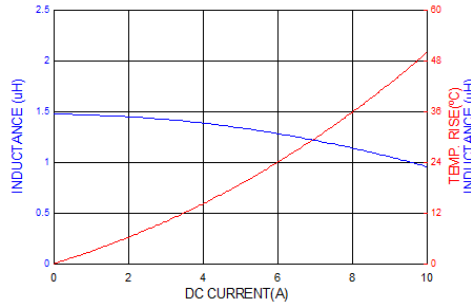

ASPIAIG-F4020-1R8

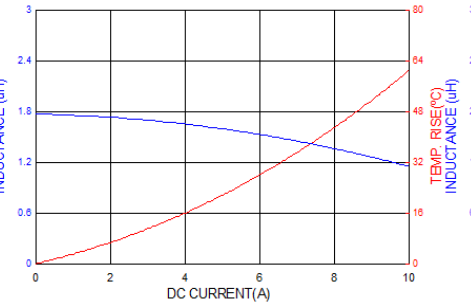

ASPIAIG-F4020-2R2

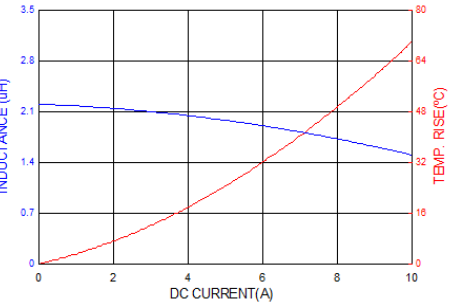

5101 Hidden Creek Ln Spicewood TX 78669
 Phone: 512-371-6159 | Fax: 512-351-8858
 For terms and conditions of sales, please visit:
www.abracon.com

REVISION A : 11/10/2021

ABRACON IS
 ISO9001-2015
 CERTIFIED

Molded SMD Power Inductor



ASPIAIG-F4020 Series

Request Samples



Check Inventory



4.4 x 4.4 x 1.9 mm
RoHS/RoHS II Compliant
 MSL Level = 1

Mechanical Specifications

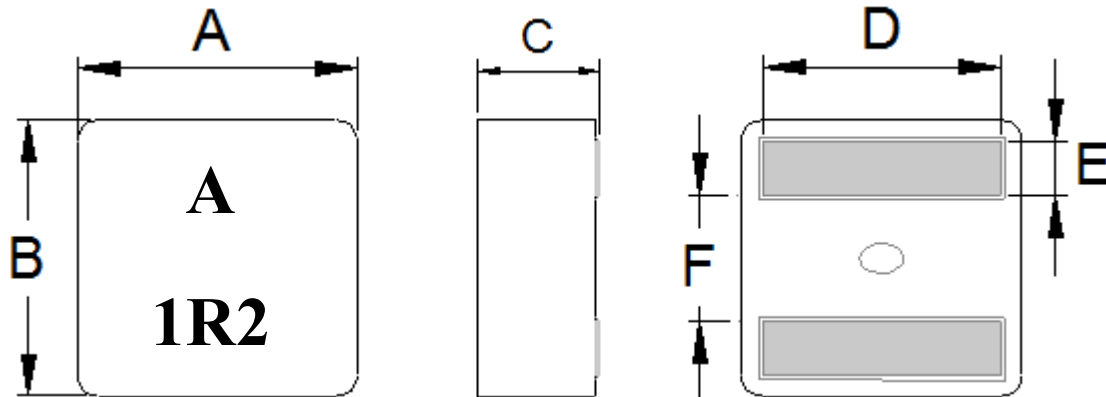

Series	A	B	C	D	E	F
ASPIAIG-F4020	4.4 ± 0.2	4.4 ± 0.2	1.9 ± 0.2	3.4 ± 0.3	0.88 ± 0.2	1.6 ± 0.25

Recommended Land Pattern

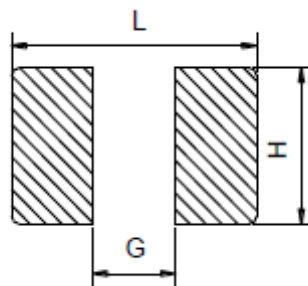

L Typ.	G Typ.	H Typ.
3.4	1.4	3.8

Dimension: mm

Molded SMD Power Inductor



ASPIAIG-F4020 Series

Request Samples



Check Inventory



4.4 x 4.4 x 1.9 mm
RoHS/RoHS II Compliant
 MSL Level = 1

Part Identification

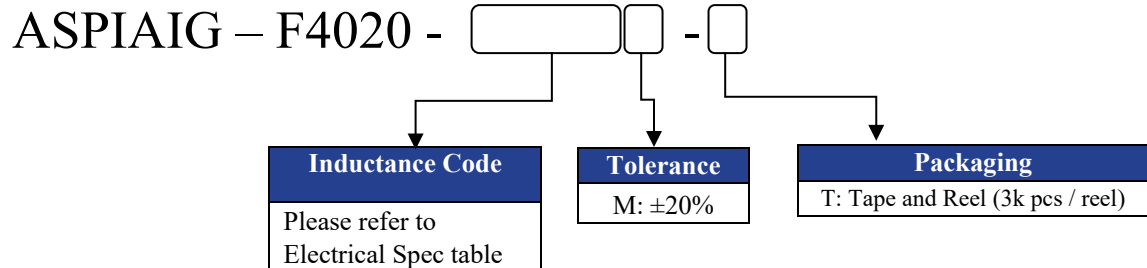

Marking

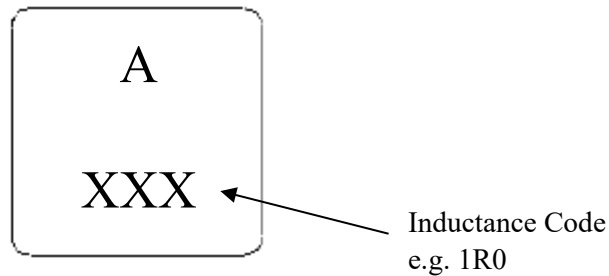

Materials

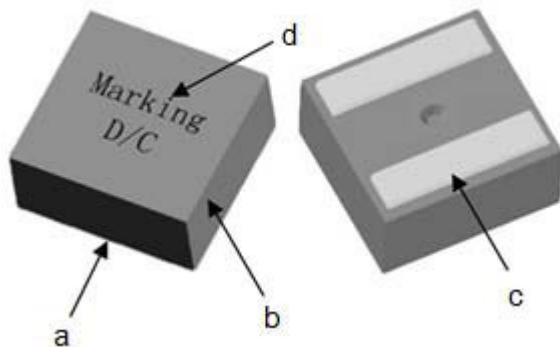

	Components	Material
a	Core	Alloy powder
b	Wire	220 deg. C Flat Wire
c	Solder	100% Pb free solder
d	Ink	Halogen-free ketone

Molded SMD Power Inductor



ASPIAIG-F4020 Series

Request Samples



Check Inventory



4.4 x 4.4 x 1.9 mm
RoHS/RoHS II Compliant
MSL Level = 1

Reflow Profile

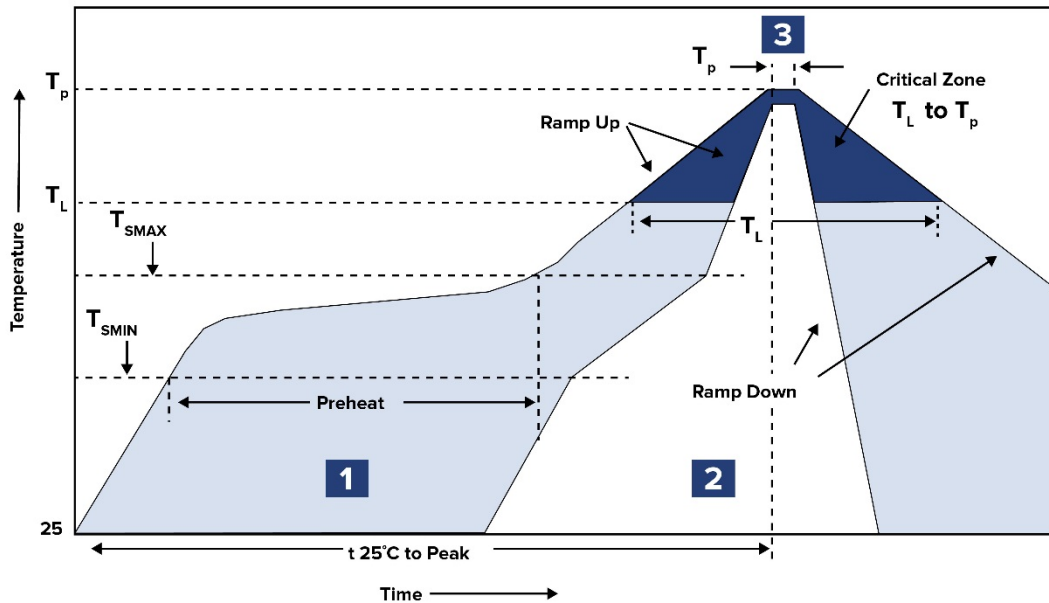

Zone	Description	Temperature	Times
1	Preheat	$T_{SMIN} \sim T_{SMAX}$ 150°C ~ 200°C	60 ~ 180 sec.
2	Reflow	T_L 217°C	60 ~ 150 sec.
3	Peak heat	T_P 260°C	10 sec. MAX

Molded SMD Power Inductor



ASPIAIG-F4020 Series

Request Samples



Check Inventory



4.4 x 4.4 x 1.9 mm
RoHS/RoHS II Compliant
 MSL Level = 1

Packaging (Tape & Reel)

ASPIAIG-F4020: 3000pcs / reel

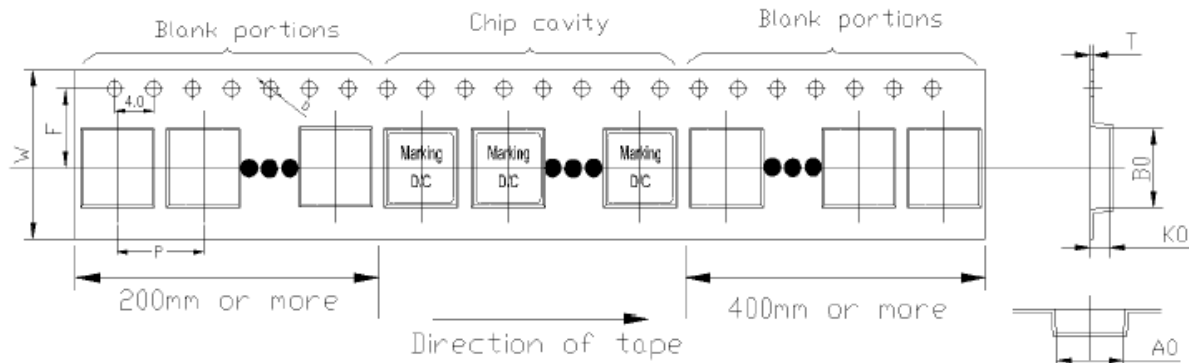

Series	W	F	P	D	A ₀	B ₀	T	K ₀
ASPIAIG-F4020	12.0±0.3	5.5±0.1	8.0±0.1	1.5±0.1	4.4±0.1	4.4 ±0.1	0.35±0.1	2.3±0.1

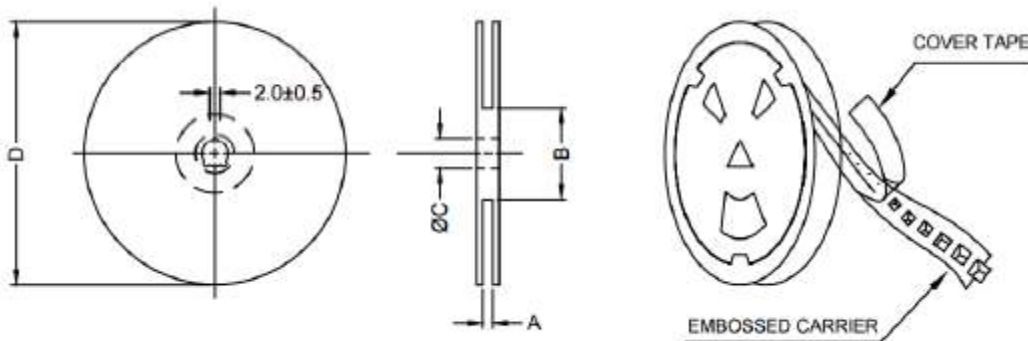

A	B	C	D
12.4+2/-0	100 ± 2	13.0+0.5/-0.2	330

Dimension: mm

ATTENTION: Abracon LLC's products are COTS – Commercial-Off-The-Shelf products; suitable for Commercial, Industrial and, where designated, Automotive Applications. Abracon's products are not specifically designed for Military, Aviation, Aerospace, Life-dependent Medical applications or any application requiring high reliability where component failure could result in loss of life and/or property. For applications requiring high reliability and/or presenting an extreme operating environment, written consent and authorization from Abracon LLC is required. Please contact Abracon LLC for more information.



5101 Hidden Creek Ln Spicewood TX 78669
 Phone: 512-371-6159 | Fax: 512-351-8858
 For terms and conditions of sales, please visit:
www.abracon.com

REVISION A : 11/10/2021

ABRACON IS
 ISO9001-2015
 CERTIFIED