

PTR060V

60 Volt DC radial leaded, PolyTron™ PTC devices



Product features

- PolyTron™ radial leaded thru-hole PTC device
- Maximum 60 V
- Current ratings from 0.10 A to 3.75 A
- Fast time-to-trip
- Low resistance
- Halogen free, Lead free, RoHS compliant

Applications

- Medical equipment
- White goods
- Industrial power transmission
- Telecommunications
- Computers and peripherals
- Consumer and automotive electronics
- Rechargeable battery packs

Agency information

- cURus: Recognized Card: File E343021 (Ihold 0.1-3.75 A)
- TUV File: R 50454364

Ordering information/

part number system

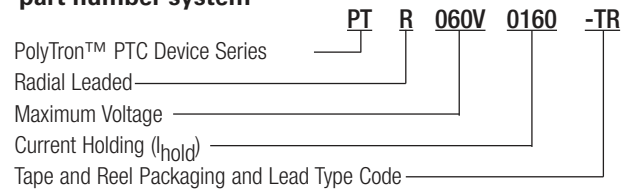

Lead Codes: TR & BK - Straight Leads, TR1 & BK1 - Kinked Leads

- | | |
|------------------------------------|----------------------------------|
| TR & TR1 On Reels | BK & BK1 In Poly Bags |
| • 0.10, 0.20-0.40 A - 3000 devices | • 0.10-0.25 A - 1000 devices |
| • 0.17 - 2,500 A devices | • 0.30-1.85 A - 500 devices |
| • 0.50-0.090 A - 2000 devices | • 2.50-3.75 A - 250 devices |
| • 1.10-1.85 A - 1200 devices | |
| • 2.50-3.75 A - 1000 devices | |

Specifications												
Catalog Number	V _{max} (Vdc)	I _{max} (A)	I _{hold} @+23 °C (A)	I _{trip} @+23 °C (A)	P _d Typ. (W)	Time to Trip (Max.)		Resistance (Ω)			Agency Information	
						(A)	(sec)	Initial (R)		Post Trip (R _f) Max.	cURus	TUV
								Min.	Max.			
PTR060V0010	60	40	0.10	0.20	0.38	0.50	4.0	2.500	4.500	7.50	X	X
PTR060V0017	60	40	0.17	0.34	0.48	0.85	3.0	3.300	5.210	8.00	X	X
PTR060V0020	60	40	0.20	0.40	0.41	1.00	2.2	1.830	2.750	4.40	X	X
PTR060V0025	60	40	0.25	0.50	0.45	1.25	2.5	1.250	1.950	3.00	X	X
PTR060V0030	60	40	0.30	0.60	0.49	1.50	3.0	0.880	1.330	2.10	X	X
PTR060V0040	60	40	0.40	0.80	0.56	2.00	3.8	0.550	0.860	1.29	X	X
PTR060V0050	60	40	0.50	1.00	0.77	2.50	4.0	0.500	0.770	1.17	X	X
PTR060V0065	60	40	0.65	1.30	0.88	3.25	5.3	0.310	0.480	0.72	X	X
PTR060V0075	60	40	0.75	1.50	0.92	3.75	6.3	0.250	0.400	0.60	X	X
PTR060V0090	60	40	0.90	1.80	0.99	4.50	7.2	0.200	0.310	0.47	X	X
PTR060V0110	60	40	1.10	2.20	1.50	5.50	8.2	0.150	0.250	0.38	X	X
PTR060V0135	60	40	1.35	2.70	1.70	6.75	9.6	0.120	0.190	0.30	X	X
PTR060V0160	60	40	1.60	3.20	1.90	8.00	11.4	0.090	0.140	0.22	X	X
PTR060V0185	60	40	1.85	3.70	2.10	9.25	12.6	0.080	0.120	0.19	X	X
PTR060V0250	60	40	2.50	5.00	2.50	12.50	15.6	0.050	0.080	0.13	X	X
PTR060V0300	60	40	3.00	6.00	2.80	15.00	19.8	0.040	0.060	0.10	X	X
PTR060V0375	60	40	3.75	7.50	3.20	18.75	24.0	0.030	0.050	0.08	X	X

Notes: I_{hold} – Hold current: Maximum current device will pass without interruption in +23 °C still air.
I_{trip} – Trip current: Minimum current that will switch the device from low resistance to high resistance in +23 °C still air.
V_{max}: Maximum continuous voltage device can withstand without damage at rated current.
I_{max}: Maximum fault current device can withstand without damage at rated voltage.
P_d: Power dissipated from device when in the tripped state in +23 °C still air.
R_f (min.): Minimum resistance of device as supplied at +23 °C unless otherwise specified.
R_f (max.): Maximum resistance of device as supplied at +23 °C unless otherwise specified.
R_f (max.): Maximum resistance of device when measured one hour post reflow (SMD) or one hour post trip (radial-leaded device) at +23 °C unless otherwise specified.



Powering Business Worldwide

Dimensions - mm

Part Number	A Max.	B Max Lead Type		C	D Min.	E Max.	F	Figure/Lead Style	
		Straight (-TR)	Kink (-TR1)					Straight TR	Kink TR1
PTR060V0010	7.4	12.7	12.7	5.0±0.8	7.6	3.5	0.5±0.02	2	1
PTR060V0017	7.4	12.7	12.7	5.0±0.8	7.6	3.5	0.5±0.02	2	1
PTR060V0020	7.4	12.2	12.2	5.0±0.8	7.6	3.5	0.5±0.02	2	1
PTR060V0025	7.4	12.7	12.7	5.0±0.8	7.6	3.5	0.5±0.02	2	1
PTR060V0030	7.4	13.0	13.0	5.0±0.8	7.6	3.5	0.5±0.02	2	1
PTR060V0040	7.6	13.5	13.5	5.0±0.8	7.6	3.5	0.5±0.02	2	1
PTR060V0050	7.6	13.7	13.7	5.0±0.8	7.6	3.5	0.5±0.02	2	1
PTR060V0065	9.7	14.5	14.5	5.0±0.8	7.6	3.5	0.5±0.02	2	1
PTR060V0075	10.4	15.2	15.2	5.0±0.8	7.6	3.5	0.5±0.02	2	1
PTR060V0090	11.7	15.7	15.7	5.0±0.8	7.6	3.5	0.5±0.02	2	1
PTR060V0110	13.0	18.0	18.0	5.0±0.8	7.6	3.5	0.8±0.02	2	1
PTR060V0135	14.5	19.6	19.6	5.0±0.8	7.6	3.5	0.8±0.02	2	1
PTR060V0160	16.3	21.3	21.3	5.0±0.8	7.6	3.5	0.8±0.02	2	1
PTR060V0185	17.8	22.9	22.9	5.0±0.8	7.6	3.5	0.8±0.02	2	1
PTR060V0250	21.3	26.4	26.4	10.0±0.8	7.6	3.5	0.8±0.02	2	1
PTR060V0300	24.9	30.0	30.0	10.0±0.8	7.6	3.5	0.8±0.02	2	1
PTR060V0375	28.4	33.5	33.5	10.0±0.8	7.6	3.5	0.8±0.02	2	1

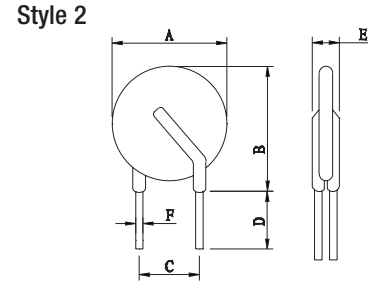
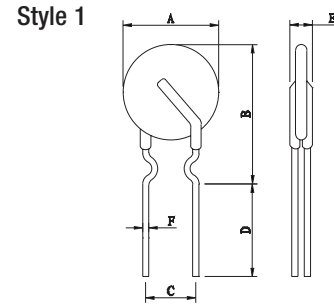

Packaging/Taping Specifications

Description	IEC Mark	Dimension (mm)	Tolerance (mm)
Sprocket hole pitch P0 12.7 0.3			
Ordinate to adjacent component lead PTR060V0010~PTR060V0090	P ₁	3.6	±1.0
Ordinate to adjacent component lead PTR060V0110~PTR060V0185	P ₁	3.45	±1.0
Ordinate to adjacent component lead PTR060V0250~PTR060V0300	P ₁	7.3	±1.0
Device pitch PTR060V0010~PTR060V0090	P	12.7	±1.0
Device pitch PTR060V0110~PTR060V0300	P	25.4	±1.0
Device pitch PTR060V0375	P	38.1	±1.0
Lead spacing	C	*	--
Carrier tape width	W	18	±1.0
Top distance between tape edges	W ₀	3.0	Max.
Hold-down tape width	W ₁	12	±1.0
Sprocket hole position	W ₂	9.0	+0.75/-0.5
Abscissa to top PTR060V0010~PTR060V0090	H ₁	32.2	Max.
Abscissa to top PTR060V0110~PTR060V0300	H ₁	47.5	Max.
Abscissa to plane (straight lead)	H	18.0	+2/-0
Abscissa to plane (kinked lead)	H ₀	16.0	±0.5
Sprocket hole diameter	D ₀	4	±0.2
Lead protrusion	L ₁	1	Max.
Tape thickness	t	0.9	Max.
Body lateral deviation	Δh	0	±1.0
Body tape plane deviation	Δp	0	±1.3
Reel width	W ₃	56	Max.
Reel diameter		340	±10
Arbor hole diameter	n ₀	31	±1
Core diameter	n	80	Min.

* See Dimensions table.

Figure 1 - PTR060V0010-PTR060V0185

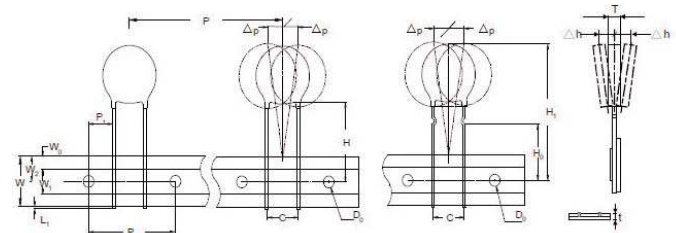
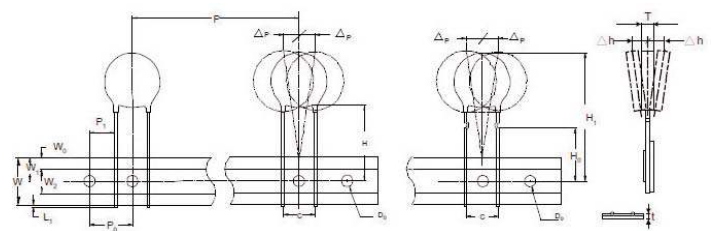
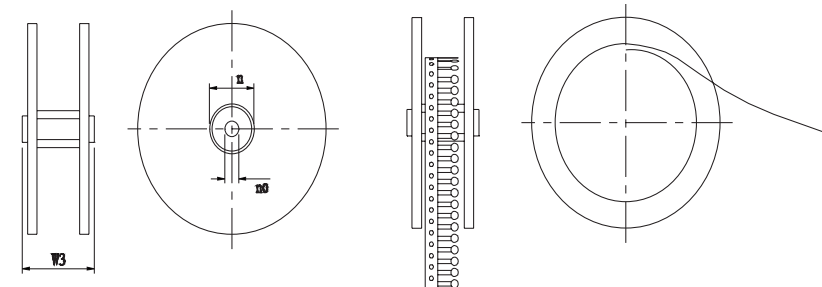

Figure 2 - PTR060V0250-PTR060V0375



Reel specification



Time-to-Trip Curves at +23 °C

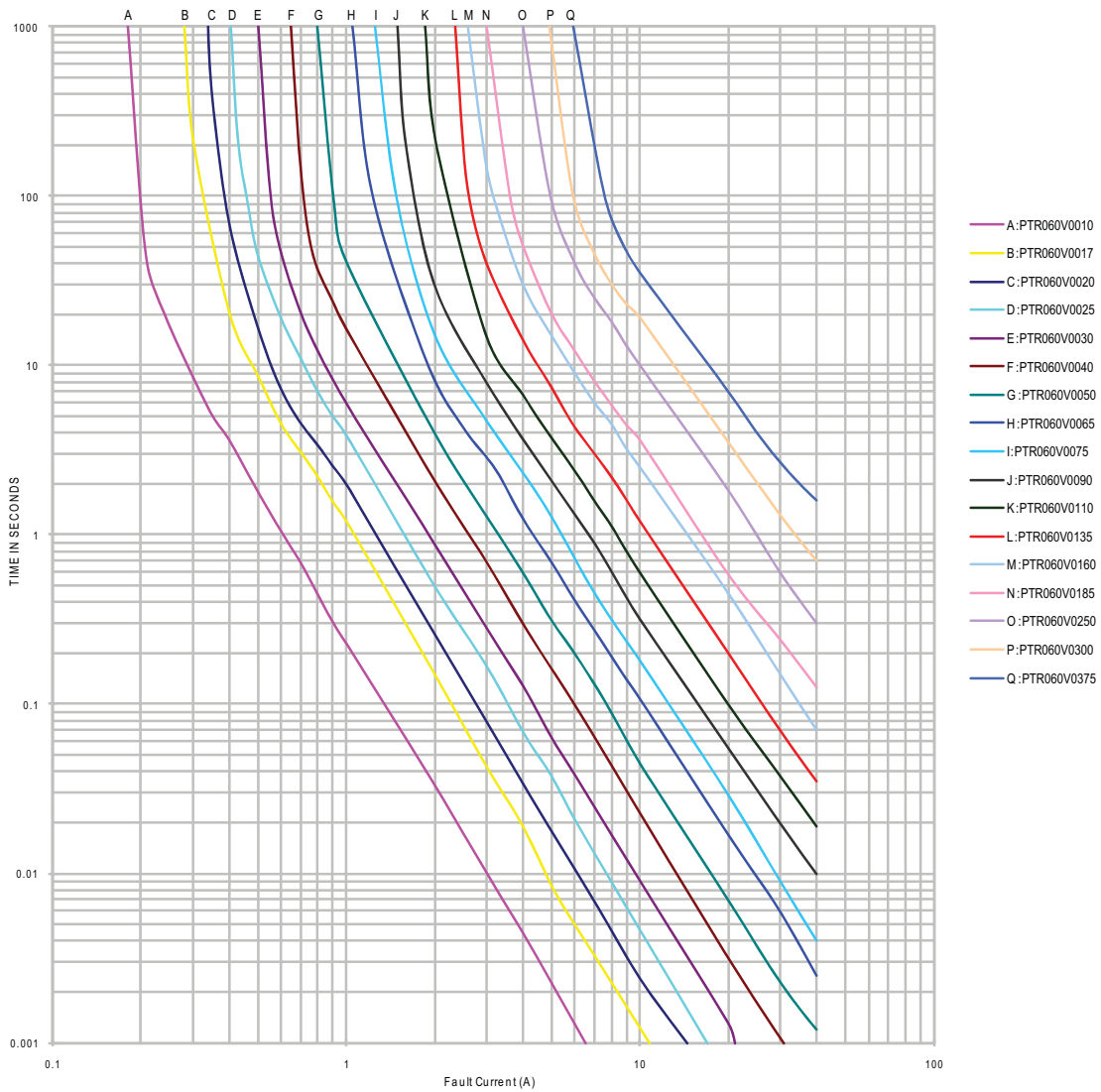

Thermal Derating Curve

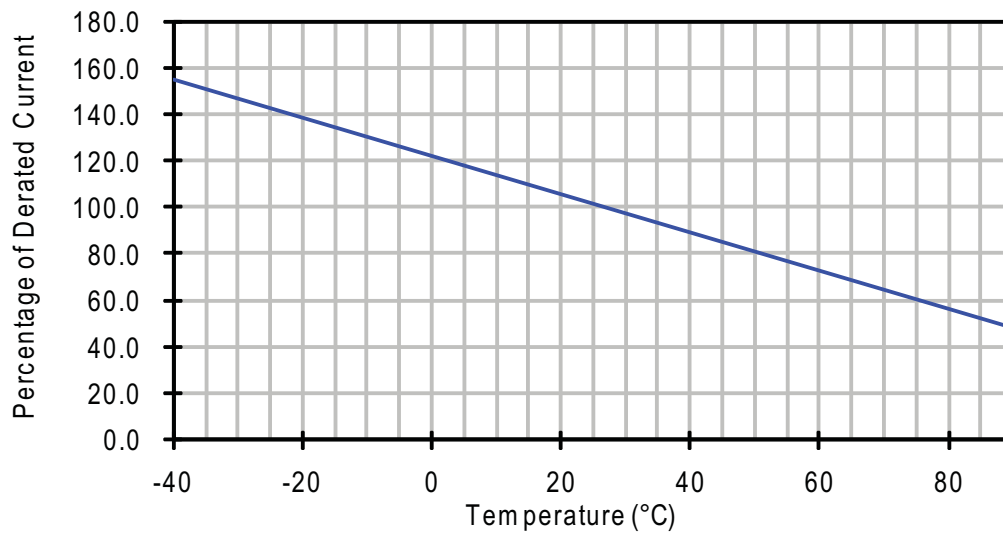

Recommended Wave Solder Profile.

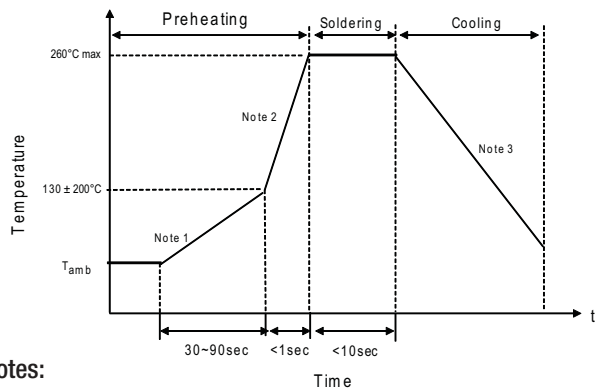

Notes:

- 1. (1-3) °C/sec
- 2. Approximately 200 °C/sec
- 3. 5 °C/sec Maximum

Recommended Reworking Conditions with Soldering Iron

- Soldering Iron Tip Temperature: +360 °C max.
- Solder Time: 3 seconds max.
- Distance from Thermistor: 2 mm min.

Environmental Specifications	
Characteristic	Value
Operating Temperature Range	-40 °C to +85 °C
Surface Temperature Trip State	+125 °C max.
Thermal Shock	+85 °C to -40 °C, 10 cycles, 5% typical resistance change
Solvent Resistance	MIL-STD-202 Method 215, no change
Humidity Age Test	+85 °C, 85% R.H., 1000 hours ±5% typical resistance change. Specified temperature (+23 °C ± 3 °C)
Storage Temperature Range	-10 °C to +40 °C
Storage Duration	One year
Storage Relative Humidity	≤75%
Storage Conditions	Keep away from corrosive atmosphere and sunlight

Material Composition

- Lead material:
 - PTR060V0010-PTR060V0040 Tin-plated copper clad steel
 - PTR060V0050-PTR060V0375 Tin-plated copper
- Insulating material: Cured epoxy resin meeting UL 94V0 requirements

Life Support Policy: Eaton does not authorize the use of any of its products for use in life support devices or systems without the express written approval of an officer of the Company. Life support systems are devices which support or sustain life, and whose failure to perform, when properly used in accordance with instructions for use provided in the labeling, can be reasonably expected to result in significant injury to the user.

Eaton reserves the right, without notice, to change design or construction of any products and to discontinue or limit distribution of any products. Eaton also reserves the right to change or update, without notice, any technical information contained in this bulletin.

Eaton
Electronics Division
1000 Eaton Boulevard
Cleveland, OH 44122
United States
www.eaton.com/electronics

© 2022 Eaton
All Rights Reserved
Printed in USA
Publication No. 4401
May 2022

Eaton is a registered trademark.

All other trademarks are property of their respective owners.

Follow us on social media to get the latest product and support information.

