

FLANGE MOUNT
(SEE SHT. 2 FOR PARTS WITH PEGS)

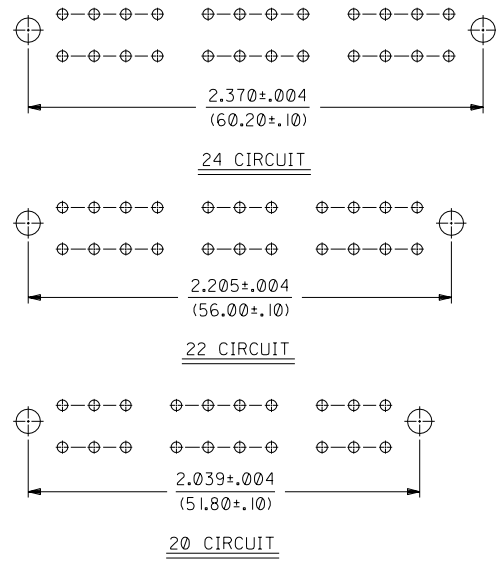

LETTER DIMENSIONS FOR ASSEMBLIES WITH FLANGES				
CKT. SIZE	DIM. "A"	DIM. "B"	DIM. "C"	DIM. "D"
2	—	.213 (5.40)	.354 (9.00)	.606 (15.40)
4	.165 (4.20)	.378 (9.60)	.520 (13.20)	.772 (19.60)
6	.331 (8.40)	.543 (13.80)	.685 (17.40)	.937 (23.80)
8	.496 (12.60)	.709 (18.00)	.850 (21.60)	1.102 (28.00)
10	.661 (16.80)	.874 (22.20)	1.016 (25.80)	1.268 (32.20)
12	.827 (21.00)	1.039 (26.40)	1.181 (30.00)	1.433 (36.40)
14	.992 (25.20)	1.205 (30.60)	1.346 (34.20)	1.598 (40.60)
16	1.157 (29.40)	1.370 (34.80)	1.512 (38.40)	1.764 (44.80)
18	1.520 (38.60)	1.732 (44.00)	1.874 (47.60)	2.126 (54.00)
20	1.685 (42.80)	1.898 (48.20)	2.039 (51.80)	2.291 (58.20)
22	1.850 (47.00)	2.063 (52.40)	2.205 (56.00)	2.457 (62.40)
24	2.016 (51.20)	2.228 (56.60)	2.370 (60.20)	2.622 (66.60)

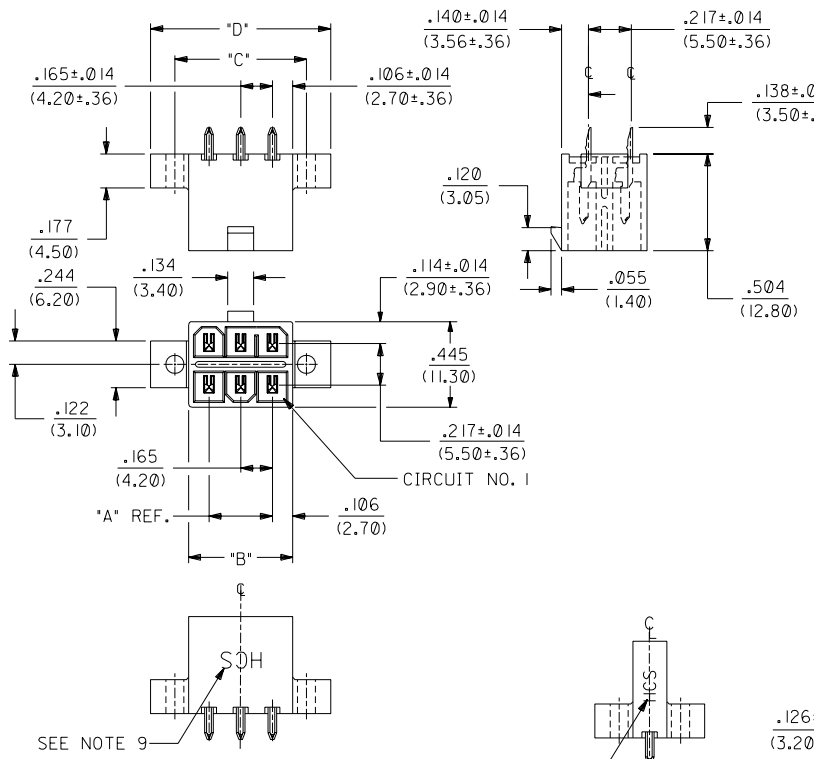

NOTES:

- HOUSING MAT'L.: POLYESTER, UNFILLED, 94V-0. COLOR: BLACK.
- TERMINAL MATERIAL: C197 ALLOY.
- PART MATES WITH RECEPTACLE 30067-*
- PRODUCT SPECIFICATION AND PROCESSING PARAMETERS: SEE PS-44476-0003.
- PART IS DESIGNED FOR USE WITH #4-40 OR M3 SELF TAPPING SCREW.
- PLATINGS:
 - * = .000100/(.00254) MIN. BRIGHT TIN OVER
 - .000050/(.00127) MIN. NICKEL.
- THE PRIMARY SHIPPING CARTON WILL BE LABELED "COMPLIANT TO RoHS DIRECTIVE 2002/95/EC AND ELV ANNEX II OF DIRECTIVE 2000/53/EC". CARTONS WITHOUT THIS LABEL MAY CONTAIN PRODUCT WITH TIN-LEAD PLATING.
- CONNECTOR ASSEMBLIES ARE NOT TO BE MATED OR UNMATED WHILE CIRCUITS ARE LIVE.
- ITEM NUMBERS PRECEDED BY AN "X" IN THE CHARTS ON SHEET 3 ARE NOT AVAILABLE.
- PARTS PRODUCED AFTER JULY 1, 2004 WILL HAVE "HCS" MARKING INSTEAD OF BLACK STRIPE.

C	REMOVED TIN-LEAD UCP2004-2049 SLINEHAN 04-04-19
B	ADD "HCS" UCP2004-1149 SLINEHAN 03-12-17
A	REL. DRAWING ECN #151235 95-06-26 A.GUZZIK
3	A
2	C
1	C
*X REL. PER ECN U40840 GEP 8-12-94	

DIMENSIONS SHOWN (METRIC) INCH UNLESS OTHERWISE SPECIFIED TOLERANCES: ANGULAR ± 1/2°		▽ = 0 ▽ = 0 REVISE ONLY ON CAD SYSTEM	
3 PL. ± .010	---	TITLE T.P.A. VERT. HDR. ASS'Y. WITH & W/O DRAIN HOLES, FLANGES & PEGS, MINI-FIT H.C.S. SERIES	
2 PL. ± .014	± 0.25	MFG. SH. REV. LTR. REVISIONS	
1 PL. ---	± 0.36	3 A 2 C 1 C	
DRAWING CONTAINS INFORMATION THAT IS PROPRIETARY TO MOLEX INC. AND SHOULD NOT BE USED WITHOUT WRITTEN PERMISSION		DATE 8/12/94	
DRAFT WHERE APPLICABLE MUST REMAIN WITHIN DIMENSIONS		PART NO. SDA-44473-1	
DRWG. NO. SDA-44473-1		DRWG. NO. SDA-44473-1	
DRW. BY GEP		CHK'D. BY RJF	
APP'D. BY RJF		SCALE 2:1	
FILE NAME 544473X1.DGN		DIV. CP	

RECOMMENDED HOLE LAYOUT FOR
.070/(1.78) MAX. THICK P.C. BOARD

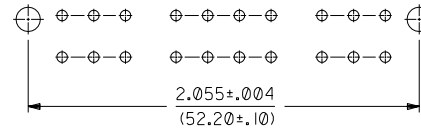
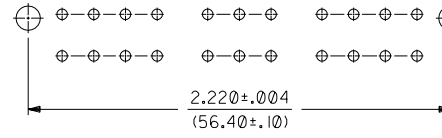
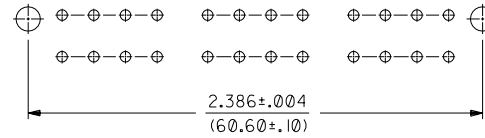
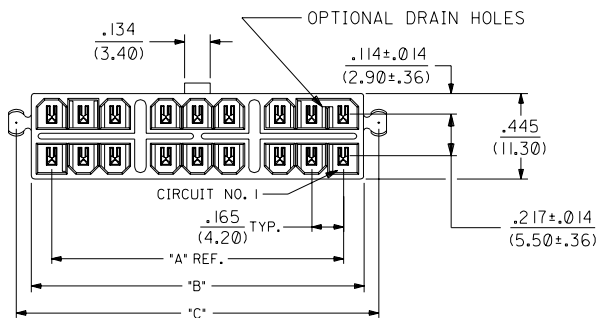
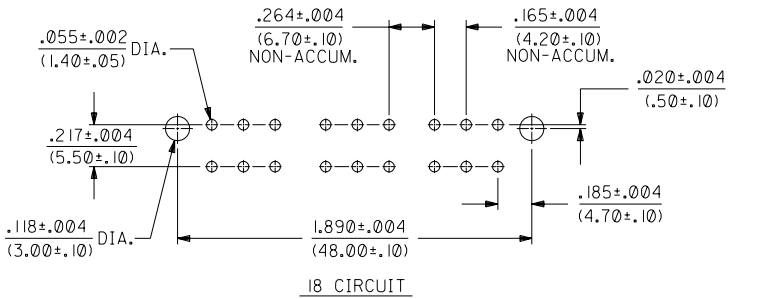

LETTER DIMENSIONS FOR ASSEMBLIES WITH PEGS

CKT. SIZE	DIM. "A"	DIM. "B"	DIM. "C"
2		.213 (5.40)	.370 (9.40)
4	.165 (4.20)	.378 (9.60)	.535 (13.60)
6	.331 (8.40)	.543 (13.80)	.701 (17.80)
8	.496 (12.60)	.709 (18.00)	.866 (22.00)
10	.661 (16.80)	.874 (22.20)	1.031 (26.20)
12	.827 (21.00)	1.039 (26.40)	1.197 (30.40)
14	.992 (25.20)	1.205 (30.60)	1.362 (34.60)
16	1.157 (29.40)	1.370 (34.80)	1.528 (38.80)
18	1.520 (38.60)	1.732 (44.00)	1.890 (48.00)
20	1.685 (42.80)	1.898 (48.20)	2.055 (52.20)
22	1.850 (47.00)	2.063 (52.40)	2.220 (56.40)
24	2.016 (51.20)	2.228 (56.60)	2.386 (60.60)

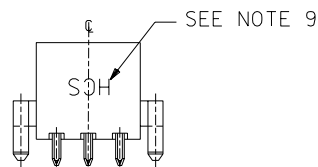
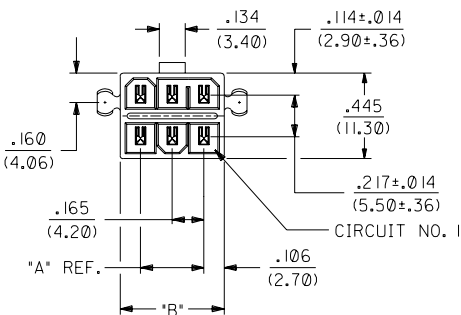
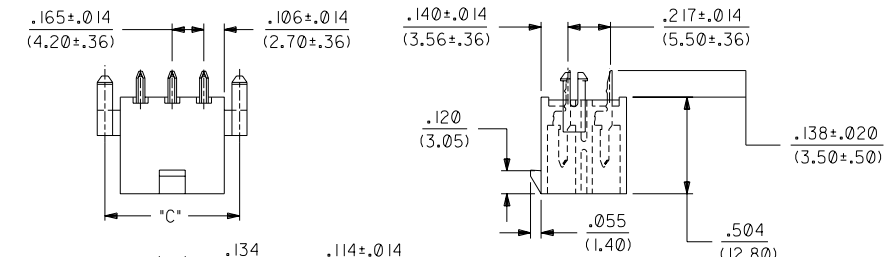

WITH PEGS
(SHOWN WITHOUT DRAIN HOLES)

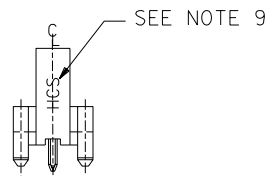

"HCS" ORIENTATION ON 2 CKT. PARTS

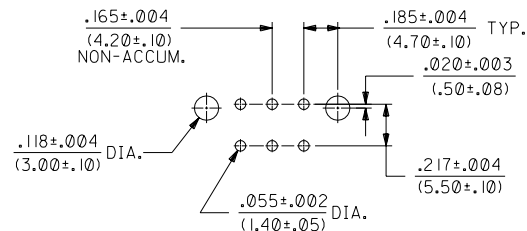

RECOMMENDED HOLE LAYOUT FOR .070/(1.78) MAX. THICK P.C. BOARD

LEGEND

- BASE NO. 44473 - ** **
- CKT. SIZE (02-24)
- HOUSING OPTIONS:
 - 1 = FLANGES, NO DRAIN HOLES
 - 2 = FLANGES, DRAIN HOLES
 - 3 = PEGS, NO DRAIN HOLES
 - 4 = PEGS, DRAIN HOLES
- PLATING: I = TIN OVER NICKEL

	REVISIONS
C	SEE SHT. 1
B	SEE SHT. 1
A	SEE SHT. 1
I	SEE SHT. 1

DIMENSIONS SHOWN (METRIC) INCH
UNLESS OTHERWISE SPECIFIED TOLERANCES: ANGULAR ± 1/2°

PLACE	INCH	METRIC
5 PLACE	± .010	---
2 PLACE	± .014	± 0.25
1 PLACE	---	± 0.36

DRAFT WHERE APPLICABLE MUST REMAIN WITHIN DIMENSIONS

DRWG. NO. 44473 - ** **

FILE NAME: S44473X2 DGA

SCALE: 2: 1

APPROVED BY: R.J.F.

DATE: 8/15/94

TITLE: T.P.A.VERT. HDR. ASS'Y. WITH & W/O DRAIN HOLES, FLANGES & PEGS, MINI-FIT H.C.S. SERIES

MOLEX INCORPORATED

SEE SHT. 3

SDA-44473-****

13			12			11			10			9			8			7			6			44473			4			3			2			1			
WITH FLANGES, NO DRAIN HOLES						WITH PEGS, NO DRAIN HOLES																																	
CKT. SIZE	ITEM NO.	PLATING SEE NOTE 6	CKT. SIZE	ITEM NO.	PLATING SEE NOTE 6	CKT. SIZE	ITEM NO.	PLATING SEE NOTE 6	CKT. SIZE	ITEM NO.	PLATING SEE NOTE 6	CKT. SIZE	ITEM NO.	PLATING SEE NOTE 6	CKT. SIZE	ITEM NO.	PLATING SEE NOTE 6	CKT. SIZE	ITEM NO.	PLATING SEE NOTE 6	CKT. SIZE	ITEM NO.	PLATING SEE NOTE 6	CKT. SIZE	ITEM NO.	PLATING SEE NOTE 6	CKT. SIZE	ITEM NO.	PLATING SEE NOTE 6	CKT. SIZE	ITEM NO.	PLATING SEE NOTE 6							
J	2	44473-0211	I	2	X 44473-0231	I	2		2			2			2			2			2			2			2			2									
	4	44473-0411	↑	4	X 44473-0431	↑	4		4			4			4			4			4			4			4			4									
I	6	44473-0611		6	44473-0631		6		6			6			6			6			6			6			6			6									
	8	44473-0811		8	X 44473-0831		8		8			8			8			8			8			8			8			8									
	10	44473-1011		10	X 44473-1031		10		10			10			10			10			10			10			10			10									
H	12	44473-1211		12	X 44473-1231		12		12			12			12			12			12			12			12			12									
	14	X 44473-1411		14	X 44473-1431		14		14			14			14			14			14			14			14			14									
	16	44473-1611		16	X 44473-1631		16		16			16			16			16			16			16			16			16									
	18	X 44473-1811		18	X 44473-1831		18		18			18			18			18			18			18			18			18									
G	20	X 44473-2011		20	X 44473-2031		20		20			20			20			20			20			20			20			20									
	22	X 44473-2211	↓	22	X 44473-2231	↓	22		22			22			22			22			22			22			22			22									
	24	X 44473-2411	I	24	X 44473-2431	I	24		24			24			24			24			24			24			24			24									
F	2	X 44473-0221	I	2	X 44473-0241	I	2		2			2			2			2			2			2			2			2									
	4	44473-0421	↑	4	X 44473-0441	↑	4		4			4			4			4			4			4			4			4									
E	6	44473-0621		6	44473-0641		6		6			6			6			6			6			6			6			6									
	8	44473-0821		8	X 44473-0841		8		8			8			8			8			8			8			8			8									
D	10	44473-1021		10	X 44473-1041		10		10			10			10			10			10			10			10			10									
	12	44473-1221		12	X 44473-1241		12		12			12			12			12			12			12			12			12									
	14	X 44473-1421		14	X 44473-1441		14		14			14			14			14			14			14			14			14									
C	16	44473-1621		16	X 44473-1641		16		16			16			16			16			16			16			16			16									
	18	X 44473-1821		18	X 44473-1841		18		18			18			18			18			18			18			18			18									
	20	X 44473-2021		20	X 44473-2041		20		20			20			20			20			20			20			20			20									
B	22	X 44473-2221	↓	22	X 44473-2241	↓	22		22			22			22			22			22			22			22			22									
	24	X 44473-2421	I	24	X 44473-2441	I	24		24			24			24			24			24			24			24			24									
A																			DIMENSIONS SHOWN (METRIC) INCH UNLESS OTHERWISE SPECIFIED TOLERANCES ANGULAR ± 1/2°			▽ = 0 ▼ = 0			REVISE ONLY ON CAD SYSTEM			TITLE T.P.A. VERT. HDR. ASS'Y. WITH & W/O DRAIN HOLES, FLANGES & PEGS, MINI-FIT H.C.S. SERIES			PART NO. SDA-44473-0000			SHEET NO. 3			DATE 8/15/94		
																			DRAFT WHERE APPLICABLE MUST REMAIN WITHIN DIMENSIONS			DRAWN BY GEP			CHK'D BY RJF			SCALE --:--			FILE NAME S44473X3			THIS DRAWING CONTAINS INFORMATION THAT IS PROPRIETARY TO MOLEX INC. AND SHOULD NOT BE USED WITHOUT WRITTEN PERMISSION			CP C		
																			LTR. REVISIONS			LTR. REVISIONS			A SEE SHT. 1			I SEE SHT. 1											