

ADC12D500RF, ADC12D800RF

ADC12D800/500RF 12-Bit, 1.6/1.0 GSPS RF Sampling ADC

Data Manual



PRODUCTION DATA information is current as of publication date. Products conform to specifications per the terms of the Texas Instruments standard warranty. Production processing does not necessarily include testing of all parameters.

Literature Number: SNAS502E
July 2011–Revised March 2013

Contents

1	Introduction	7
1.1	Features	7
1.2	Applications	7
1.3	Description	7
2	Device Information	8
2.1	Block Diagram	8
2.2	RF Performance	9
2.3	ADC12D800/500RF Connection Diagram	10
2.4	Ball Descriptions and Equivalent Circuits	11
3	Electrical Specifications	19
3.1	Absolute Maximum Ratings	19
3.2	Operating Ratings	19
3.3	Package Thermal Resistance	20
3.4	Converter Electrical Characteristics Static Converter Characteristics	20
3.5	Converter Electrical Characteristics Dynamic Converter Characteristics	21
3.6	Converter Electrical Characteristics Analog Input/Output and Reference Characteristics	24
3.7	Converter Electrical Characteristics I-Channel to Q-Channel Characteristics	25
3.8	Converter Electrical Characteristics Sampling Clock Characteristics	25
3.9	Converter Electrical Characteristics AutoSync Feature Characteristics	25
3.10	Converter Electrical Characteristics Digital Control and Output Pin Characteristics	26
3.11	Converter Electrical Characteristics Power Supply Characteristics	27
3.12	Converter Electrical Characteristics AC Electrical Characteristics	27
3.13	Converter Electrical Characteristics Serial Port Interface	29
3.14	Converter Electrical Characteristics Calibration	29
4	Specification Definitions	30
4.1	Transfer Characteristic	32
4.2	Timing Diagrams	33
5	Typical Performance Plots	36
6	Functional Description	46
6.1	Overview	46
6.2	Control modes	46
6.2.1	Non-Extended Control Mode	46
6.2.1.1	Dual Edge Sampling Pin (DES)	47
6.2.1.2	Non-Demultiplexed Mode Pin (NDM)	47
6.2.1.3	Dual Data Rate Phase Pin (DDRPh)	47
6.2.1.4	Calibration Pin (CAL)	48
6.2.1.5	Calibration Delay Pin (CalDly)	48
6.2.1.6	Power Down I-channel Pin (PDI)	48
6.2.1.7	Power Down Q-channel Pin (PDQ)	48
6.2.1.8	Test Pattern Mode Pin (TPM)	48
6.2.1.9	Full-Scale Input Range Pin (FSR)	49
6.2.1.10	AC/DC-Coupled Mode Pin (V_{CMO})	49
6.2.1.11	LVDS Output Common-mode Pin (V_{BG})	49
6.2.2	Extended Control Mode	49

6.2.2.1	The Serial Interface	49
6.3	Features	51
6.3.1	Input Control and Adjust	53
6.3.1.1	AC/DC-coupled Mode	53
6.3.1.2	Input Full-Scale Range Adjust	53
6.3.1.3	Input Offset Adjust	53
6.3.1.4	DES/Non-DES Mode	53
6.3.1.5	DES Timing Adjust	54
6.3.1.6	Sampling Clock Phase Adjust	54
6.3.2	Output Control and Adjust	54
6.3.2.1	SDR / DDR Clock	54
6.3.2.2	LVDS Output Differential Voltage	55
6.3.2.3	LVDS Output Common-Mode Voltage	55
6.3.2.4	Output Formatting	56
6.3.2.5	Demux/Non-demux Mode	56
6.3.2.6	Test Pattern Mode	56
6.3.2.7	Time Stamp	57
6.3.3	Calibration Feature	57
6.3.3.1	Calibration Control Pins and Bits	57
6.3.3.2	How to Execute a Calibration	58
6.3.3.3	Power-on Calibration	58
6.3.3.4	On-command Calibration	58
6.3.3.5	Calibration Adjust	59
6.3.3.6	Read/Write Calibration Settings	59
6.3.3.7	Calibration and Power-Down	60
6.3.3.8	Calibration and the Digital Outputs	60
6.3.4	Power Down	60
6.4	Applications Information	60
6.4.1	THE ANALOG INPUTS	60
6.4.1.1	Acquiring the Input	60
6.4.1.2	Driving the ADC in DES Mode	60
6.4.1.3	FSR and the Reference Voltage	61
6.4.1.4	Out-Of-Range Indication	62
6.4.1.5	Maximum Input Range	62
6.4.1.6	AC-coupled Input Signals	62
6.4.1.7	DC-coupled Input Signals	63
6.4.1.8	Single-Ended Input Signals	63
6.4.2	THE CLOCK INPUTS	63
6.4.2.1	CLK Coupling	63
6.4.2.2	CLK Frequency	64
6.4.2.3	CLK Level	64
6.4.2.4	CLK Duty Cycle	64
6.4.2.5	CLK Jitter	64
6.4.2.6	CLK Layout	64
6.4.3	THE LVDS OUTPUTS	65
6.4.3.1	Common-mode and Differential Voltage	65
6.4.3.2	Output Data Rate	65
6.4.3.3	Terminating Unused LVDS Output Pins	65
6.4.4	SYNCHRONIZING MULTIPLE ADC12D800/500RFS IN A SYSTEM	65
6.4.4.1	AutoSync Feature	66
6.4.4.2	DCLK Reset Feature	66
6.4.5	SUPPLY/GROUNDING, LAYOUT AND THERMAL RECOMMENDATIONS	67
6.4.5.1	Power Planes	67

6.4.5.2	Bypass Capacitors	67
6.4.5.3	Ground Planes	67
6.4.5.4	Power System Example	68
6.4.5.5	Thermal Management	68
6.4.6	SYSTEM POWER-ON CONSIDERATIONS	70
6.4.6.1	Power-on, Configuration, and Calibration	70
6.4.6.2	Power-on and Data Clock (DCLK)	71
6.4.7	RECOMMENDED SYSTEM CHIPS	72
6.4.7.1	Temperature Sensor	72
6.4.7.2	Clocking Device	73
6.4.7.3	Amplifiers for the Analog Input	73
6.4.7.4	Balun Recommendations for Analog Input	73
6.5	Register Definitions	74
Revision History		80

List of Figures

2-1	ADC12D800RF DES Mode IMD ₃	9
2-2	ADC12D800RF DES Mode FFT	10
2-3	See Package Number NXA0292A	10
4-1	LVDS Output Signal Levels	31
4-2	Input / Output Transfer Characteristic	33
4-3	Clocking in 1:2 Demux Non-DES Mode*.....	33
4-4	Clocking in Non-Demux Non-DES Mode*.....	34
4-5	Clocking in 1:4 Demux DES Mode*.....	34
4-6	Clocking in Non-Demux Mode DES Mode*.....	34
4-7	Data Clock Reset Timing (Demux Mode)	35
4-8	Power-on and On-Command Calibration Timing.....	35
4-9	Serial Interface Timing.....	35
6-1	Serial Data Protocol - Read Operation	51
6-2	Serial Data Protocol - Write Operation	51
6-3	DDR DCLK-to-Data Phase Relationship	55
6-4	SDR DCLK-to-Data Phase Relationship	55
6-5	Driving DESIQ Mode.....	61
6-6	AC-coupled Differential Input	62
6-7	Single-Ended to Differential Conversion Using a Balun.....	63
6-8	Differential Input Clock Connection	64
6-9	AutoSync Example	66
6-10	Power and Grounding Example	68
6-11	HSBGA Conceptual Drawing	69
6-12	Power-on with Control Pins set by Pull-up/down Resistors.....	71
6-13	Power-on with Control Pins set by FPGA pre Power-on Cal	71
6-14	Power-on with Control Pins set by FPGA post Power-on Cal.....	71
6-15	Supply and DCLK Ramping.....	72
6-16	Typical Temperature Sensor Application.....	73

List of Tables

2-1	Analog Front-End and Clock Balls	11
2-2	Control and Status Balls	13
2-3	Power and Ground Balls	16
2-4	High-Speed Digital Outputs	17
6-1	Non-ECM Pin Summary	47
6-2	Serial Interface Pins.....	49
6-3	Command and Data Field Definitions	50
6-4	Features and Modes	52
6-5	Supported Demux, Data Rate Modes	56
6-6	Test Pattern by Output Port in Demux Mode.....	56
6-7	Test Pattern by Output Port in Non-Demux Mode.....	57
6-8	Calibration Pins	58
6-9	Unused Analog Input Recommended Termination	61
6-10	Unused AutoSync and DCLK Reset Pin Recommendation	66
6-11	Temperature Sensor Recommendation	72
6-12	Amplifier Recommendations	73
6-13	Balun Recommendations.....	73
6-14	Register Addresses	74
6-15	Configuration Register 1.....	74
6-16	Reserved	75
6-17	I-channel Offset Adjust	75
6-18	I-channel Full Scale Range Adjust.....	75
6-19	Calibration Adjust.....	76
6-20	Calibration Values	76
6-21	Reserved - ADC12D800RF	76
6-22	Reserved - ADC12D500RF	76
6-23	DES Timing Adjust	77
6-24	Reserved	77
6-25	Reserved	77
6-26	Q-channel Offset Adjust	77
6-27	Q-channel Full-Scale Range Adjust	78
6-28	Aperture Delay Coarse Adjust	78
6-29	Aperture Delay Fine Adjust	78
6-30	AutoSync	79
6-31	Reserved	79

ADC12D800/500RF 12-Bit, 1.6/1.0 GSPS RF Sampling ADC

Check for Samples: [ADC12D500RF](#), [ADC12D800RF](#)

1 Introduction

1.1 Features

- Excellent Noise and Linearity up to and Above $f_{IN} = 2.7$ GHz
- Configurable to Either 1.6/1.0 GSPS Interleaved or 800/500 MSPS Dual ADC
- New DESCLKIQ Mode for High Bandwidth, High Sampling Rate Apps
- Pin-Compatible with ADC1xD1x00
- AutoSync Feature for Multi-Chip Synchronization
- Internally Terminated, Buffered, Differential Analog Inputs
- Interleaved Timing Automatic and Manual Skew Adjust
- Test Patterns at Output for System Debug
- Time Stamp Feature to Capture External Trigger
- Programmable Gain, Offset, and t_{AD} Adjust Feature
- 1:1 Non-Demuxed or 1:2 Demuxed LVDS Outputs
- Key Specifications
 - Resolution 12 Bits
 - Interleaved 1.6/1.0 GSPS ADC
 - IMD_3 ($F_{in} = 2.7$ GHz @ -13dBFS): -63/-61 dBc (typ)
 - IMD_3 ($F_{in} = 2.7$ GHz @ -16dBFS): -71/-69 dBc (typ)
 - Noise Floor: -152.2/-150.5 dBm/Hz (typ)
 - Noise Power Ratio: 50.4/50.7 dB (typ)
 - Power: 2.50/2.02 W (typ)
 - Dual 800/500 MSPS ADC, $F_{in} = 498$ MHz
 - ENOB: 9.5/9.6 Bits (typ)
 - SNR: 59.7/59.7 dB (typ)
 - SFDR: 71.2/72 dBc (typ)
 - Power per Channel: 1.25/1.01 W (typ)

1.2 Applications

- 3G/4G Wireless Basestation
 - Receive Path
 - DPD Path
- Wideband Microwave Backhaul
- RF Sampling Software Defined Radio
- Military Communications
- SIGINT
- RADAR / LIDAR
- Wideband Communications
- Consumer RF
- Test and Measurement

1.3 Description

The 12-bit 1.6/1.0 GSPS ADC12D800/500RF is an RF-sampling GSPS ADC that can directly sample input frequencies up to and above 2.7 GHz. The ADC12D800/500RF augments the very large Nyquist zone of TI's GSPS ADCs with excellent noise and linearity performance at RF frequencies, extending its usable range beyond the 7th Nyquist zone

The ADC12D800/500RF provides a flexible LVDS interface which has multiple SPI programmable options to facilitate board design and FPGA/ASIC data capture. The LVDS outputs are compatible with IEEE 1596.3-1996 and supports programmable common mode voltage. The product is packaged in a lead-free 292-ball thermally enhanced BGA package over the rated industrial temperature range of -40°C to +85°C.



Please be aware that an important notice concerning availability, standard warranty, and use in critical applications of Texas Instruments semiconductor products and disclaimers thereto appears at the end of this data sheet.

All trademarks are the property of their respective owners.

2 Device Information

2.1 Block Diagram

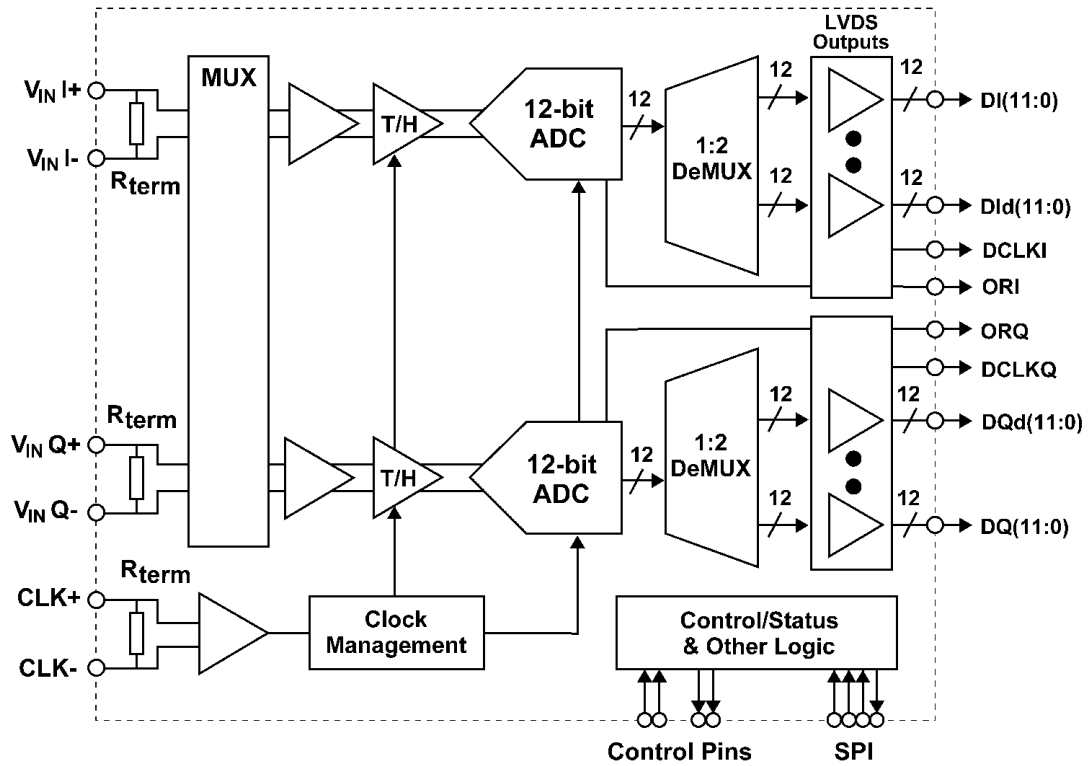

2.2 RF Performance

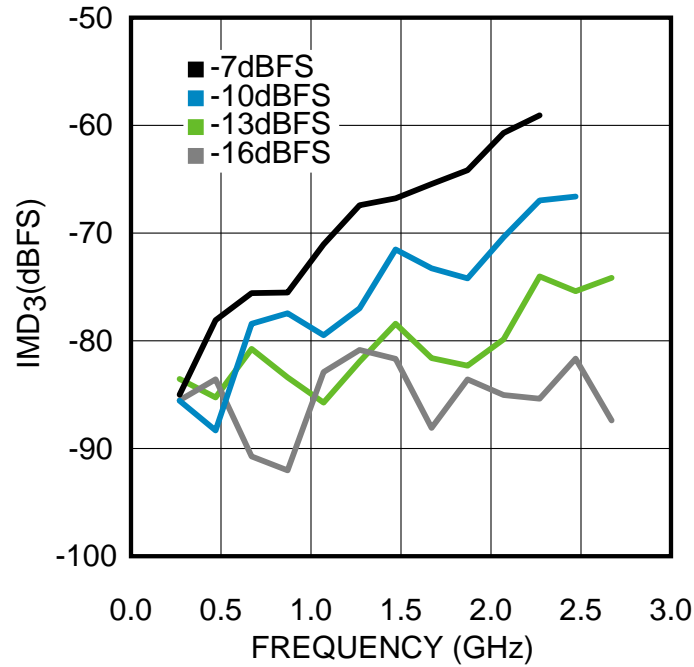

- A. CW Blocker: $f_{in} = 2710.47\text{MHz}$; Total Power = -13dBFS
- B. WCDMA Blocker: $f_c = 2700\text{MHz}$; Bandwidth = 3.84MHz; Total Power = -13dBFS
- C. IMD_3 Product Power = -73dBFS

Figure 2-1. ADC12D800RF DES Mode IMD_3

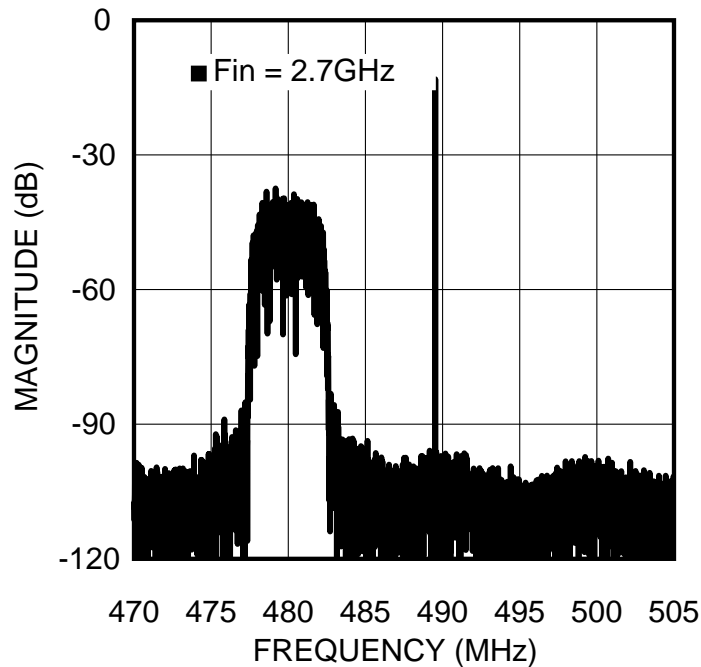

Figure 2-2. ADC12D800RF DES Mode FFT

2.3 ADC12D800/500RF Connection Diagram

	1	2	3	4	5	6	7	8	9	10	11	12	13	14	15	16	17	18	19	20	
A	GND	V_A	SDO	TPM	NDM	V_A	GND	V_E	GND_E	Did0+	V_DR	Did3+	GND_DR	Did6+	V_DR	Did9+	GND_DR	Did11+	Did11-	GND_DR	A
B	Vbg	GND	ECEb	SDI	CalRun	V_A	GND	GND_E	V_E	Did0-	Did2+	Did3-	Did5+	Did6-	Did8+	Did9-	Did10+	DI0+	DI1+	DI1-	B
C	Rtrim+	Vcmo	Rext+	SCSb	SCLK	V_A	NC	V_E	GND_E	Did1+	Did2-	Did4+	Did5-	Did7+	Did8-	Did10-	DI0-	V_DR	DI2+	DI2-	C
D	DNC	Rtrim-	Rext-	GND	GND	CAL	DNC	V_A	V_A	Did1-	V_DR	Did4-	GND_DR	Did7-	V_DR	GND_DR	V_DR	DI3+	DI4+	DI4-	D
E	V_A	Tdiode+	DNC	GND													GND_DR	DI3-	DI5+	DI5-	E
F	V_A	GND_TC	Tdiode-	DNC													GND_DR	DI6+	DI6-	GND_DR	F
G	V_TC	GND_TC	V_TC	V_TC													DI7+	DI7-	DI8+	DI8-	G
H	VinI+	V_TC	GND_TC	V_A	GND						GND						DI9+	DI9-	DI10+	DI10-	H
J	VinI-	GND_TC	V_TC	VbiasI	GND						GND						V_DR	DI11+	DI11-	V_DR	J
K	GND	VbiasI	V_TC	GND_TC	GND						GND						ORI+	ORI-	DCLKI+	DCLKI-	K
L	GND	VbiasQ	V_TC	GND_TC	GND						GND						ORQ+	ORQ-	DCLKQ+	DCLKQ-	L
M	VinQ-	GND_TC	V_TC	VbiasQ	GND						GND						GND_DR	DQ11+	DQ11-	GND_DR	M
N	VinQ+	V_TC	GND_TC	V_A	GND						GND						DQ9+	DQ9-	DQ10+	DQ10-	N
P	V_TC	GND_TC	V_TC	V_TC	GND						GND						DQ7+	DQ7-	DQ8+	DQ8-	P
R	V_A	GND_TC	V_TC	V_TC													V_DR	DQ6+	DQ6-	V_DR	R
T	V_A	GND_TC	GND_TC	GND													V_DR	DQ3-	DQ5+	DQ5-	T
U	GND_TC	CLK+	PDI	GND	GND	RCOut1-	DNC	V_A	V_A	DQd1-	V_DR	DQd4-	GND_DR	DQd7-	V_DR	V_DR	GND_DR	DQ3+	DQ4+	DQ4-	U
V	CLK-	DCLK_RST+	PDQ	CalDly	DES	RCOut2+	RCOut2-	V_E	GND_E	DQd1+	DQd2-	DQd4+	DQd5-	DQd7+	DQd8-	DQd10-	DQ0-	GND_DR	DQ2+	DQ2-	V
W	DCLK_RST-	GND	DNC	DDRPh	RCLK-	V_A	GND	GND_E	V_E	DQd0-	DQd2+	DQd3-	DQd5+	DQd6-	DQd8+	DQd9-	DQd10+	DQ0+	DQ1+	DQ1-	W
Y	GND	V_A	FSR	RCLK+	RCOut1+	V_A	GND	V_E	GND_E	DQd0+	V_DR	DQd3+	GND_DR	DQd6+	V_DR	DQd9+	GND_DR	DQd11+	DQd11-	GND_DR	Y

Figure 2-3. See Package Number NXA0292A

The center ground pins are for thermal dissipation and must be soldered to a ground plane to ensure rated performance. See [SUPPLY/GROUNDING, LAYOUT AND THERMAL RECOMMENDATIONS](#) for more information.

2.4 Ball Descriptions and Equivalent Circuits

Table 2-1. Analog Front-End and Clock Balls

Ball No.	Name	Equivalent Circuit	Description
H1/J1 N1/M1	VinI+/- VinQ+/-		<p>Differential signal I- and Q-inputs. In the Non-Dual Edge Sampling (Non-DES) Mode, each I- and Q-input is sampled and converted by its respective channel with each positive transition of the CLK input. In Non-ECM (Non-Extended Control Mode) and DES Mode, both channels sample the I-input. In Extended Control Mode (ECM), the Q-input may optionally be selected for conversion in DES Mode by the DEQ Bit (Addr: 0h, Bit 6).</p> <p>Each I- and Q-channel input has an internal common mode bias that is disabled when DC-coupled Mode is selected. Both inputs must be either AC- or DC-coupled. The coupling mode is selected by the V_{CMO} Pin.</p> <p>In Non-ECM, the full-scale range of these inputs is determined by the FSR Pin; both I- and Q-channels have the same full-scale input range. In ECM, the full-scale input range of the I- and Q-channel inputs may be independently set via the Control Register (Addr: 3h and Addr: Bh). Note that the high and low full-scale input range setting in Non-ECM corresponds to the mid and minimum full-scale input range in ECM.</p> <p>The input offset may also be adjusted in ECM.</p>
U2/V1	CLK+/-		<p>Differential Converter Sampling Clock. In the Non-DES Mode, the analog inputs are sampled on the positive transitions of this clock signal. In the DES Mode, the selected input is sampled on both transitions of this clock. This clock must be AC-coupled.</p>
V2/W1	DCLK_RST+/-		<p>Differential DCLK Reset. A positive pulse on this input is used to reset the DCLKI and DCLKQ outputs of two or more ADC12D800/500RFs in order to synchronize them with other ADC12D800/500RFs in the system. DCLKI and DCLKQ are always in phase with each other, unless one channel is powered down, and do not require a pulse from DCLK_RST to become synchronized. The pulse applied here must meet timing relationships with respect to the CLK input. Although supported, this feature has been superseded by AutoSync. ⁽¹⁾</p>

(1) This pin/bit functionality is not tested in production test; performance is tested in the specified/default mode only.

Table 2-1. Analog Front-End and Clock Balls (continued)

Ball No.	Name	Equivalent Circuit	Description
C2	V _{CMO}		<p>Common Mode Voltage Output or Signal Coupling Select. If AC-coupled operation at the analog inputs is desired, this pin should be held at logic-low level. This pin is capable of sourcing/ sinking up to 100 μA. For DC-coupled operation, this pin should be left floating or terminated into high-impedance. In DC-coupled Mode, this pin provides an output voltage which is the optimal common-mode voltage for the input signal and should be used to set the common-mode voltage of the driving buffer.</p>
B1	V _{BG}		<p>Bandgap Voltage Output or LVDS Common-mode Voltage Select. This pin provides a buffered version of the bandgap output voltage and is capable of sourcing/sinking 100 μA and driving a load of up to 80 pF. Alternately, this pin may be used to select the LVDS digital output common-mode voltage. If tied to logic-high, the 1.2V LVDS common-mode voltage is selected; 0.8V is the default.</p>
C3/D3	Rext+/-		<p>External Reference Resistor terminals. A 3.3 kΩ \pm0.1% resistor should be connected between Rext+/- . The Rext resistor is used as a reference to trim internal circuits which affect the linearity of the converter; the value and precision of this resistor should not be compromised.</p>
C1/D2	Rtrim+/-		<p>Input Termination Trim Resistor terminals. A 3.3 kΩ \pm0.1% resistor should be connected between Rtrim+/- . The Rtrim resistor is used to establish the calibrated 100Ω input impedance of VinI, VinQ and CLK. These impedances may be fine tuned by varying the value of the resistor by a corresponding percentage; however, the tuning range and performance is not specified for such an alternate value.</p>
E2/F3	Tdiode+/-		<p>Temperature Sensor Diode Positive (Anode) and Negative (Cathode) Terminals. This set of pins is used for die temperature measurements. It has not been fully characterized.</p>

Table 2-1. Analog Front-End and Clock Balls (continued)

Ball No.	Name	Equivalent Circuit	Description
Y4/W5	RCLK+/-		<p>Reference Clock Input. When the AutoSync feature is active, and the ADC12D800/500RF is in Slave Mode, the internal divided clocks are synchronized with respect to this input clock. The delay on this clock may be adjusted when synchronizing multiple ADCs. This feature is available in ECM via Control Register (Addr: Eh).⁽¹⁾</p>
Y5/U6 V6/V7	RCOut1+/- RCOut2+/-		<p>Reference Clock Output 1 and 2. These signals provide a reference clock at a rate of CLK/4, when enabled, independently of whether the ADC is in Master or Slave Mode. They are used to drive the RCLK of another ADC12D800/500RF, to enable automatic synchronization for multiple ADCs (AutoSync feature). The impedance of each trace from RCOut1 and RCOut2 to the RCLK of another ADC12D800/500RF should be 100Ω differential. Having two clock outputs allows the auto-synchronization to propagate as a binary tree. Use the DOC Bit (Addr: Eh, Bit 1) to enable/disable this feature; default is disabled.⁽¹⁾</p>

(1) This pin/bit functionality is not tested in production test; performance is tested in the specified/default mode only.

Table 2-2. Control and Status Balls

Ball No.	Name	Equivalent Circuit	Description
V5	DES		<p>Dual Edge Sampling (DES) Mode select. In the Non-Extended Control Mode (Non-ECM), when this input is set to logic-high, the DES Mode of operation is selected, meaning that the VinI input is sampled by both channels in a time-interleaved manner. The VinQ input is ignored. When this input is set to logic-low, the device is in Non-DES Mode, i.e. the I- and Q-channels operate independently. In the Extended Control Mode (ECM), this input is ignored and DES Mode selection is controlled through the Control Register by the DES Bit (Addr: 0h, Bit 7); default is Non-DES Mode operation.</p>
V4	CalDly		<p>Calibration Delay select. By setting this input logic-high or logic-low, the user can select the device to wait a longer or shorter amount of time, respectively, before the automatic power-on self-calibration is initiated. This feature is pin-controlled only and is always active during ECM and Non-ECM.</p>

Table 2-2. Control and Status Balls (continued)

Ball No.	Name	Equivalent Circuit	Description
D6	CAL		Calibration cycle initiate. The user can command the device to execute a self-calibration cycle by holding this input high a minimum of t_{CAL_H} after having held it low a minimum of t_{CAL_L} . If this input is held high at the time of power-on, the automatic power-on calibration cycle is inhibited until this input is cycled low-then-high. This pin is active in both ECM and Non-ECM. In ECM, this pin is logically OR'd with the CAL Bit (Addr: 0h, Bit 15) in the Control Register. Therefore, both pin and bit must be set low and then either can be set high to execute an on-command calibration.
B5	CalRun		Calibration Running indication. This output is logic-high while the calibration sequence is executing. This output is logic-low otherwise.
U3 V3	PDI PDQ		Power Down I- and Q-channel. Setting either input to logic-high powers down the respective I- or Q-channel. Setting either input to logic-low brings the respective I- or Q-channel to a operational state after a finite time delay. This pin is active in both ECM and Non-ECM. In ECM, each Pin is logically OR'd with its respective Bit. Therefore, either this pin or the PDI and PDQ Bit in the Control Register can be used to power-down the I- and Q-channel (Addr: 0h, Bit 11 and Bit 10), respectively.
A4	TPM		Test Pattern Mode select. With this input at logic-high, the device continuously outputs a fixed, repetitive test pattern at the digital outputs. In the ECM, this input is ignored and the Test Pattern Mode can only be activated through the Control Register by the TPM Bit (Addr: 0h, Bit 12).
A5	NDM		Non-Demuxed Mode select. Setting this input to logic-high causes the digital output bus to be in the 1:1 Non-Demuxed Mode. Setting this input to logic-low causes the digital output bus to be in the 1:2 Demuxed Mode. This feature is pin-controlled only and remains active during ECM and Non-ECM.

Table 2-2. Control and Status Balls (continued)

Ball No.	Name	Equivalent Circuit	Description
Y3	FSR		<p>Full-Scale input Range select. In Non-ECM, when this input is set to logic-low or logic-high, the full-scale differential input range for both I- and Q-channel inputs is set to the lower or higher FSR value, respectively. In the ECM, this input is ignored and the full-scale range of the I- and Q-channel inputs is independently determined by the setting of Addr: 3h and Addr: Bh, respectively. Note that the high (lower) FSR value in Non-ECM corresponds to the mid (min) available selection in ECM; the FSR range in ECM is greater.</p>
W4	DDRPh		<p>DDR Phase select. This input, when logic-low, selects the 0° Data-to-DCLK phase relationship. When logic-high, it selects the 90° Data-to-DCLK phase relationship, i.e. the DCLK transition indicates the middle of the valid data outputs. This pin only has an effect when the chip is in 1:2 Demuxed Mode, i.e. the NDM pin is set to logic-low. In ECM, this input is ignored and the DDR phase is selected through the Control Register by the DPS Bit (Addr: 0h, Bit 14); the default is 0° Mode.</p>
B3	$\overline{\text{ECE}}$		<p>Extended Control Enable bar. Extended feature control through the SPI interface is enabled when this signal is asserted (logic-low). In this case, most of the direct control pins have no effect. When this signal is de-asserted (logic-high), the SPI interface is disabled, all SPI registers are reset to their default values, and all available settings are controlled via the control pins.</p>
C4	$\overline{\text{SCS}}$		<p>Serial Chip Select bar. In ECM, when this signal is asserted (logic-low), SCLK is used to clock in serial data which is present on SDI and to source serial data on SDO. When this signal is de-asserted (logic-high), SDI is ignored and SDO is in tri-stated.</p>
C5	SCLK		<p>Serial Clock. In ECM, serial data is shifted into and out of the device synchronously to this clock signal. This clock may be disabled and held logic-low, as long as timing specifications are not violated when the clock is enabled or disabled.</p>

Table 2-2. Control and Status Balls (continued)

Ball No.	Name	Equivalent Circuit	Description
B4	SDI		Serial Data-In. In ECM, serial data is shifted into the device on this pin while \overline{SCS} signal is asserted (logic-low).
A3	SDO		Serial Data-Out. In ECM, serial data is shifted out of the device on this pin while \overline{SCS} signal is asserted (logic-low). This output is tri-stated when \overline{SCS} is de-asserted.
D1, D7, E3, F4, W3, U7	DNC	NONE	Do Not Connect. These pins are used for internal purposes and should not be connected, i.e. left floating. Do not ground.
C7	NC	NONE	Not Connected. This pin is not bonded and may be left floating or connected to any potential.

Table 2-3. Power and Ground Balls

Ball No.	Name	Equivalent Circuit	Description
A2, A6, B6, C6, D8, D9, E1, F1, H4, N4, R1, T1, U8, U9, W6, Y2, Y6	V_A	NONE	Power Supply for the Analog circuitry. This supply is tied to the ESD ring. Therefore, it must be powered up before or with any other supply.
G1, G3, G4, H2, J3, K3, L3, M3, N2, P1, P3, P4, R3, R4	V_{TC}	NONE	Power Supply for the Track-and-Hold and Clock circuitry.
A11, A15, C18, D11, D15, D17, J17, J20, R17, R20, T17, U11, U15, U16, Y11, Y15	V_{DR}	NONE	Power Supply for the Output Drivers.
A8, B9, C8, V8, W9, Y8	V_E	NONE	Power Supply for the Digital Encoder.
J4, K2	VbiasI	NONE	Bias Voltage I-channel. This is an externally decoupled bias voltage for the I-channel. Each pin should individually be decoupled with a 100 nF capacitor via a low resistance, low inductance path to GND.
L2, M4	VbiasQ	NONE	Bias Voltage Q-channel. This is an externally decoupled bias voltage for the Q-channel. Each pin should individually be decoupled with a 100 nF capacitor via a low resistance, low inductance path to GND.

Table 2-3. Power and Ground Balls (continued)

Ball No.	Name	Equivalent Circuit	Description
A1, A7, B2, B7, D4, D5, E4, K1, L1, T4, U4, U5, W2, W7, Y1, Y7, H8:N13	GND	NONE	Ground Return for the Analog circuitry.
F2, G2, H3, J2, K4, L4, M2, N3, P2, R2, T2, T3, U1	GND _{TC}	NONE	Ground Return for the Track-and-Hold and Clock circuitry.
A13, A17, A20, D13, D16, E17, F17, F20, M17, M20, U13, U17, V18, Y13, Y17, Y20	GND _{DR}	NONE	Ground Return for the Output Drivers.
A9, B8, C9, V9, W8, Y9	GND _E	NONE	Ground Return for the Digital Encoder.

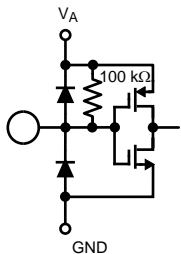
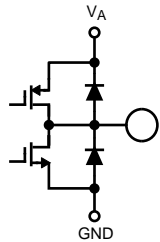
Table 2-4. High-Speed Digital Outputs

Ball No.	Name	Equivalent Circuit	Description
K19/K20 L19/L20	DCLKI+/- DCLKQ+/-		<p>Data Clock Output for the I- and Q-channel data bus. These differential clock outputs are used to latch the output data and, if used, should always be terminated with a 100Ω differential resistor placed as closely as possible to the differential receiver. Delayed and non-delayed data outputs are supplied synchronously to this signal. In 1:2 Demux Mode or Non-Demux Mode, this signal is at ¼ or ½ the sampling clock rate, respectively. DCLKI and DCLKQ are always in phase with each other, unless one channel is powered down, and do not require a pulse from DCLK_RST to become synchronized.</p>
K17/K18 L17/L18	ORI+/- ORQ+/-		<p>Out-of-Range Output for the I- and Q-channel. This differential output is asserted logic-high while the over- or under-range condition exists, i.e. the differential signal at each respective analog input exceeds the full-scale value. Each OR result refers to the current Data, with which it is clocked out. If used, each of these outputs should always be terminated with a 100Ω differential resistor placed as closely as possible to the differential receiver.</p>

Table 2-4. High-Speed Digital Outputs (continued)

Ball No.	Name	Equivalent Circuit	Description
J18/J19 H19/H20 H17/H18 G19/G20 G17/G18 F18/F19 E19/E20 D19/D20 D18/E18 C19/C20 B19/B20 B18/C17 M18/M19 N19/N20 N17/N18 P19/P20 P17/P18 R18/R19 T19/T20 U19/U20 U18/T18 V19/V20 W19/W20 W18/V17	DI11+/- DI10+/- DI9+/- DI8+/- DI7+/- DI6+/- DI5+/- DI4+/- DI3+/- DI2+/- DI1+/- DI0+/- DQ11+/- DQ10+/- DQ9+/- DQ8+/- DQ7+/- DQ6+/- DQ5+/- DQ4+/- DQ3+/- DQ2+/- DQ1+/- DQ0+/-		<p>I- and Q-channel Digital Data Outputs. In Non-Demux Mode, this LVDS data is transmitted at the sampling clock rate. In Demux Mode, these outputs provide ½ the data at ½ the sampling clock rate, synchronized with the delayed data, i.e. the other ½ of the data which was sampled one clock cycle earlier. Compared with the DI_d and DQ_d outputs, these outputs represent the later time samples. If used, each of these outputs should always be terminated with a 100Ω differential resistor placed as closely as possible to the differential receiver.</p>
A18/A19 B17/C16 A16/B16 B15/C15 C14/D14 A14/B14 B13/C13 C12/D12 A12/B12 B11/C11 C10/D10 A10/B10 Y18/Y19 W17/V16 Y16/W16 W15/V15 V14/U14 Y14/W14 W13/V13 V12/U12 Y12/W12 W11/V11 V10/U10 Y10/W10	DId11+/- DId10+/- DId9+/- DId8+/- DId7+/- DId6+/- DId5+/- DId4+/- DId3+/- DId2+/- DId1+/- DId0+/- DQd11+/- DQd10+/- DQd9+/- DQd8+/- DQd7+/- DQd6+/- DQd5+/- DQd4+/- DQd3+/- DQd2+/- DQd1+/- DQd0+/-		<p>Delayed I- and Q-channel Digital Data Outputs. In Non-Demux Mode, these outputs are tri-stated. In Demux Mode, these outputs provide ½ the data at ½ the sampling clock rate, synchronized with the non-delayed data, i.e. the other ½ of the data which was sampled one clock cycle later. Compared with the DI and DQ outputs, these outputs represent the earlier time samples. If used, each of these outputs should always be terminated with a 100Ω differential resistor placed as closely as possible to the differential receiver.</p>

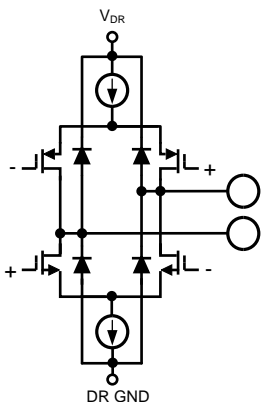
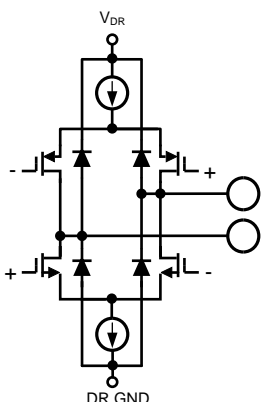

These devices have limited built-in ESD protection. The leads should be shorted together or the device placed in conductive foam during storage or handling to prevent electrostatic damage to the MOS gates.

3 Electrical Specifications

3.1 Absolute Maximum Ratings⁽¹⁾⁽²⁾

Supply Voltage (V_A , V_{TC} , V_{DR} , V_E)	2.2V	
Supply Difference $\max(V_{A/TC/DR/E}) - \min(V_{A/TC/DR/E})$	0V to 100 mV	
Voltage on Any Input Pin (except $V_{IN+/-}$)	-0.15V to ($V_A + 0.15V$)	
$V_{IN+/-}$ Voltage Range	-0.5V to 2.5V	
Ground Difference $\max(GND_{TC/DR/E}) - \min(GND_{TC/DR/E})$	0V to 100 mV	
Input Current at Any Pin ⁽³⁾	± 50 mA	
ADC12D800/500RF Package Power Dissipation at $T_A \leq 85^\circ\text{C}$ ⁽³⁾	3.45 W	
ESD Susceptibility ⁽⁴⁾	Human Body Model	2500V
	Charged Device Model	1000V
	Machine Model	250V
Storage Temperature	-65°C to +150°C	

- (1) Absolute Maximum Ratings indicate limits beyond which damage to the device may occur. There is no specification of operation at the Absolute Maximum Ratings. Operating Ratings indicate conditions for which the device is functional, but do not ensure specific performance limits. For ensured specifications and test conditions, see the Electrical Characteristics. The ensured specifications apply only for the test conditions listed. Some performance characteristics may degrade when the device is not operated under the listed test conditions.
- (2) All voltages are measured with respect to $GND = GND_{TC} = GND_{DR} = GND_E = 0V$, unless otherwise specified.
- (3) When the input voltage at any pin exceeds the power supply limits, i.e. less than GND or greater than V_A , the current at that pin should be limited to 50 mA. In addition, over-voltage at a pin must adhere to the maximum voltage limits. Simultaneous over-voltage at multiple pins requires adherence to the maximum package power dissipation limits. These dissipation limits are calculated using JEDEC JESD51-7 thermal model. Higher dissipation may be possible based on specific customer thermal situation and specified package thermal resistances from junction to case.
- (4) Human body model is 100 pF capacitor discharged through a 1.5 k Ω resistor. Machine model is 220 pF discharged through 0 Ω . Charged device model simulates a pin slowly acquiring charge (such as from a device sliding down the feeder in an automated assembler) then rapidly being discharged.

3.2 Operating Ratings⁽¹⁾⁽²⁾

ADC12D800/500RF Ambient Temperature Range (Standard JEDEC thermal model)	$-40^\circ\text{C} \leq T_A \leq 85^\circ\text{C}$
Junction Temperature Range	$T_J \leq 135^\circ\text{C}$
Supply Voltage (V_A , V_{TC} , V_E)	+1.8V to +2.0V
Driver Supply Voltage (V_{DR})	+1.8V to V_A
$V_{IN+/-}$ Voltage Range ⁽³⁾	-0.4V to 2.4V (DC)
$V_{IN+/-}$ Differential Voltage ⁽³⁾	1.0V (d.c.-coupled @ 100% duty cycle) 2.0V (d.c.-coupled @ 20% duty cycle) 2.8V (d.c.-coupled @ 10% duty cycle)
$V_{IN+/-}$ Current Range ⁽³⁾	± 50 mA (a.c.-coupled)
$V_{IN+/-}$ Power	15.3 dBm (maintaining common mode voltage, a.c.-coupled) 17.1 dBm (not maintaining common-mode voltage, a.c.-coupled)
Ground Difference $\max(GND_{TC/DR/E}) - \min(GND_{TC/DR/E})$	0V

- (1) Absolute Maximum Ratings indicate limits beyond which damage to the device may occur. There is no specification of operation at the Absolute Maximum Ratings. Operating Ratings indicate conditions for which the device is functional, but do not ensure specific performance limits. For ensured specifications and test conditions, see the Electrical Characteristics. The ensured specifications apply only for the test conditions listed. Some performance characteristics may degrade when the device is not operated under the listed test conditions.
- (2) All voltages are measured with respect to $GND = GND_{TC} = GND_{DR} = GND_E = 0V$, unless otherwise specified.
- (3) Proper common mode voltage must be maintained to ensure proper output codes, especially during input overdrive.

Operating Ratings⁽¹⁾⁽²⁾ (continued)

CLK+/- Voltage Range	0V to V _A
Differential CLK Amplitude	0.4V _{P-P} to 2.0V _{P-P}
Common Mode Input Voltage	V _{CMO} - 150 mV < V _{CMI} < V _{CMO} +150 mV

3.3 Package Thermal Resistance⁽¹⁾⁽²⁾

Package	θ _{JA}	θ _{JC1}	θ _{JC2}
292-Ball BGA Thermally Enhanced Package	16°C/W	2.9°C/W	2.5°C/W

- (1) Soldering process must comply with Texas Instrument's Reflow Temperature Profile specifications. Refer to www.ti.com/packaging. See (Note 2).
- (2) Reflow temperature profiles are different for lead-free and non-lead-free packages.

**3.4 Converter Electrical Characteristics
Static Converter Characteristics**

Unless otherwise specified, the following apply after calibration for V_A = V_{DR} = V_{TC} = V_E = +1.9V; I- and Q-channels, AC-coupled, unused channel terminated to AC ground, FSR Pin = High; C_L = 10 pF; Differential, AC coupled Sine Wave Sampling Clock, f_{CLK} = 800/500 MHz at 0.5 V_{P-P} with 50% duty cycle (as specified); V_{BG} = Floating; Non-Extended Control Mode; Rext = Rtrim = 3300Ω ± 0.1%; Analog Signal Source Impedance = 100Ω Differential; Non-Demux Non-DES Mode; Duty Cycle Stabilizer on. **Boldface limits apply for T_A = T_{MIN} to T_{MAX}**. All other limits T_A = 25°C, unless otherwise noted. (1)(2)(3)

Symbol	Parameter	Conditions	ADC12D800RF		ADC12D500RF		Units (Limits)
			Typ	Lim	Typ	Lim	
	Resolution with No Missing Codes			12		12	bits
INL	Integral Non-Linearity (Best fit)	1 MHz DC-coupled over-ranged sine wave	±2.5	±7.25	±2.5	±7.25	LSB (max)
DNL	Differential Non-Linearity	1 MHz DC-coupled over-ranged sine wave	±0.4	±0.95	±0.4	±0.95	LSB (max)
V _{OFF}	Offset Error		5		5		LSB
V _{OFF_ADJ}	Input Offset Adjustment Range	Extended Control Mode	±45		±45		mV
PFSE	Positive Full-Scale Error	See (4)		±30		±30	mV (max)
NFSE	Negative Full-Scale Error	See (4)		±30		±30	mV (max)
	Out-of-Range Output Code ⁽⁵⁾	(V _{IN+}) - (V _{IN-}) > + Full Scale		4095		4095	
		(V _{IN+}) - (V _{IN-}) < - Full Scale		0		0	

- (1) The analog inputs, labeled "I/O", are protected as shown below. Input voltage magnitudes beyond the Absolute Maximum Ratings may damage this device.

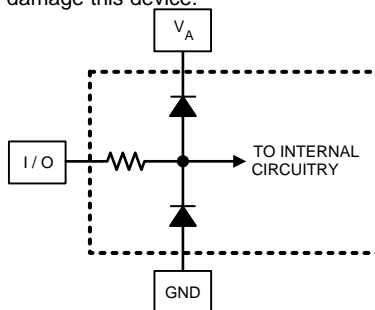

- (2) To ensure accuracy, it is required that V_A, V_{TC}, V_E and V_{DR} be well-bypassed. Each supply pin must be decoupled with separate bypass capacitors.
- (3) Typical figures are at T_A = 25°C, and represent most likely parametric norms. Test limits are specified to TI's AOQL (Average Outgoing Quality Level).
- (4) Calculation of Full-Scale Error for this device assumes that the actual reference voltage is exactly its nominal value. Full-Scale Error for this device, therefore, is a combination of Full-Scale Error and Reference Voltage Error. See Figure 4-2. For relationship between Gain Error and Full-Scale Error, see Specification Definitions for Gain Error.
- (5) This parameter is ensured by design and is not tested in production.

3.5 Converter Electrical Characteristics Dynamic Converter Characteristics ⁽¹⁾

Symbol	Parameter	Conditions	ADC12D800RF		ADC12D500RF		Units (Limits)	
			Typ	Lim	Typ	Lim		
	Bandwidth	Non-DES Mode, DESCLKIQ Mode						
		-3dB ⁽²⁾	2.7		2.7		GHz	
		-6dB	3.1		3.1		GHz	
		-9dB	3.5		3.5		GHz	
		-12dB	4.0		4.0		GHz	
		DESI, DESQ Mode						
		-3dB ⁽²⁾	1.2		1.2		GHz	
		-6dB	2.3		2.3		GHz	
		-9dB	2.7		2.7		GHz	
		-12dB	3.0		3.0		GHz	
		DESIQ Mode						
		-3dB ⁽²⁾	1.75		1.75		GHz	
		-6dB	2.7		2.7		GHz	
			Gain Flatness	Non-DES Mode				
D.C. to $F_s/2$	± 0.1				± 0.02		dB	
D.C. to F_s	± 0.3				± 0.3		dB	
D.C. to $3F_s/2$	± 0.5				± 0.3		dB	
DESI, DESQ Mode								
D.C. to $F_s/2$	± 0.7				± 0.6		dB	
D.C. to F_s	± 2.2				± 1.0		dB	
D.C. to $3F_s/2$	± 3.4				± 1.8		dB	
DESIQ Mode								
D.C. to $F_s/2$	± 0.6				± 0.3		dB	
D.C. to F_s	± 1.1				± 0.7		dB	
D.C. to $3F_s/2$	± 2.0				± 1.1		dB	
DESCLKIQ Mode								
D.C. to $F_s/2$	± 0.4				± 0.2		dB	
D.C. to F_s	± 0.7				± 0.5		dB	
D.C. to $3F_s/2$	± 1.0				± 0.7		dB	
CER	Code Error Rate		10^{-18}		10^{-18}	Error/Sample		
NPR	Noise Power Ratio	DES Mode, $f_{c,notch} = F_s/4$, Notch width = 5% of $F_s/2$	50.4		50.7	dB		
IMD ₃	3rd order Intermodulation Distortion	DES Mode						
		$F_{IN} = 2670\text{MHz} \pm 2.5\text{MHz} @$ -13dBFS	-76		-74		dBFS	
			-63		-61		dBc	
		$F_{IN} = 2070\text{MHz} \pm 2.5\text{MHz} @$ -13dBFS	-80		-79		dBFS	
			-67		-66		dBc	
		$F_{IN} = 2670\text{MHz} \pm 2.5\text{MHz} @$ -16dBFS	-87		-85		dBFS	
			-71		-69		dBc	
		$F_{IN} = 2070\text{MHz} \pm 2.5\text{MHz} @$ -16dBFS	-85		-84		dBFS	
-69			-68		dBc			

(1) This parameter is ensured by design and/or characterization and is not tested in production.

(2) The -3dB point is the traditional Full-Power Bandwidth (FPBW) specification. Although the insertion loss is approximately half at this frequency, the dynamic performance of the ADC does not necessarily begin to degrade to a level below which it may be effectively used in an application. The ADC may be used at input frequencies above the -3dB FPBW point, for example, into the 5th and 6th Nyquist zones. Depending on system requirements, it is only necessary to compensate for the insertion loss.

Converter Electrical Characteristics
Dynamic Converter Characteristics ⁽¹⁾ (continued)

Symbol	Parameter	Conditions	ADC12D800RF		ADC12D500RF		Units (Limits)
			Typ	Lim	Typ	Lim	
	Noise Floor Density	50Ω single-ended input termination, DES Mode	-152.2		-150.5		dBm/Hz
			-151.2		-149.6		dBFS/Hz
Non-DES Mode⁽³⁾⁽⁴⁾⁽⁵⁾							
ENOB	Effective Number of Bits	A _{IN} = 125 MHz @ -0.5 dBFS	9.6	9.1	9.7	9.1	bits (min)
		A _{IN} = 248 MHz @ -0.5 dBFS	9.5		9.7		bits
		A _{IN} = 498 MHz @ -0.5 dBFS	9.5		9.6		bits
		A _{IN} = 998 MHz @ -0.5 dBFS	9.2		9.3		bits
		A _{IN} = 1498 MHz @ -0.5 dBFS	8.9		9.2		bits
SINAD	Signal-to-Noise Plus Distortion Ratio	A _{IN} = 125 MHz @ -0.5 dBFS	59.7		60.0		dB
		A _{IN} = 248 MHz @ -0.5 dBFS	58.7		59.9		dB
		A _{IN} = 498 MHz @ -0.5 dBFS	58.8		59.4		dB
		A _{IN} = 998 MHz @ -0.5 dBFS	57.1		58.0		dB
		A _{IN} = 1498 MHz @ -0.5 dBFS	55.1		56.9		dB
SNR	Signal-to-Noise Ratio	A _{IN} = 125 MHz @ -0.5 dBFS	60.2	57.5	60.4	57.5	dB (min)
		A _{IN} = 248 MHz @ -0.5 dBFS	59.8		60.3		dB
		A _{IN} = 498 MHz @ -0.5 dBFS	59.7		59.7		dB
		A _{IN} = 998 MHz @ -0.5 dBFS	58.4		58.7		dB
		A _{IN} = 1498 MHz @ -0.5 dBFS	56.4		57.3		dB
THD	Total Harmonic Distortion	A _{IN} = 125 MHz @ -0.5 dBFS	-69.0	-62.5	-71.4	-62.5	dB (max)
		A _{IN} = 248 MHz @ -0.5 dBFS	-65.1		-70.3		dB
		A _{IN} = 498 MHz @ -0.5 dBFS	-66.0		-70.4		dB
		A _{IN} = 998 MHz @ -0.5 dBFS	-63.2		-66.5		dB
		A _{IN} = 1498 MHz @ -0.5 dBFS	-60.8		-67.4		dB
2nd Harm	Second Harmonic Distortion	A _{IN} = 125 MHz @ -0.5 dBFS	80.1		80.5		dBc
		A _{IN} = 248 MHz @ -0.5 dBFS	78.5		77.0		dBc
		A _{IN} = 498 MHz @ -0.5 dBFS	77.9		85.7		dBc
		A _{IN} = 998 MHz @ -0.5 dBFS	67.9		81.0		dBc
		A _{IN} = 1498 MHz @ -0.5 dBFS	63.1		76.5		dBc
3rd Harm	Third Harmonic Distortion	A _{IN} = 125 MHz @ -0.5 dBFS	76.3		77.6		dBc
		A _{IN} = 248 MHz @ -0.5 dBFS	66.5		73.8		dBc
		A _{IN} = 498 MHz @ -0.5 dBFS	73.2		74.4		dBc
		A _{IN} = 998 MHz @ -0.5 dBFS	66.8		68.5		dBc
		A _{IN} = 1498 MHz @ -0.5 dBFS	68.8		70.3		dBc
SFDR	Spurious-Free Dynamic Range	A _{IN} = 125 MHz @ -0.5 dBFS	73.4	62.5	74.3	62.5	dBc (min)
		A _{IN} = 248 MHz @ -0.5 dBFS	66.5		73.8		dBc
		A _{IN} = 498 MHz @ -0.5 dBFS	71.2		72.0		dBc
		A _{IN} = 998 MHz @ -0.5 dBFS	66.8		68.5		dBc
		A _{IN} = 1498 MHz @ -0.5 dBFS	63.1		70.5		dBc

- (3) The Dynamic Specifications are ensured for room to hot ambient temperature only (25°C to 85°C). Refer to the plots of the dynamic performance vs. temperature in the [Typical Performance Plots](#) to see typical performance from cold to room temperature (-40°C to 25°C).
- (4) The Fs/2 spur was removed from all the dynamic performance specifications.
- (5) Typical dynamic performance at Fin = 248 MHz, 498 MHz, 998 MHz, and 1498 MHz is ensured by design and/or characterization and is not tested in production.

Converter Electrical Characteristics
Dynamic Converter Characteristics ⁽¹⁾ (continued)

Symbol	Parameter	Conditions	ADC12D800RF		ADC12D500RF		Units (Limits)
			Typ	Lim	Typ	Lim	
DES Mode ⁽¹⁾⁽²⁾							
ENOB	Effective Number of Bits	A _{IN} = 125 MHz @ -0.5 dBFS	9.4		9.6		bits
		A _{IN} = 248 MHz @ -0.5 dBFS	9.3		9.5		bits
		A _{IN} = 498 MHz @ -0.5 dBFS	9.3		9.5		bits
		A _{IN} = 998 MHz @ -0.5 dBFS	9		9.2		bits
		A _{IN} = 1498 MHz @ -0.5 dBFS	8.7		8.7		bits
SINAD	Signal-to-Noise Plus Distortion Ratio	A _{IN} = 125 MHz @ -0.5 dBFS	58.6		59.6		dB
		A _{IN} = 248 MHz @ -0.5 dBFS	57.8		59.0		dB
		A _{IN} = 498 MHz @ -0.5 dBFS	57.9		59.0		dB
		A _{IN} = 998 MHz @ -0.5 dBFS	55.8		57.3		dB
		A _{IN} = 1498 MHz @ -0.5 dBFS	54.0		53.5		dB
SNR	Signal-to-Noise Ratio	A _{IN} = 125 MHz @ -0.5 dBFS	59.1		60.0		dB
		A _{IN} = 248 MHz @ -0.5 dBFS	58.5		59.6		dB
		A _{IN} = 498 MHz @ -0.5 dBFS	58.3		59.4		dB
		A _{IN} = 998 MHz @ -0.5 dBFS	56.2		58.1		dB
		A _{IN} = 1498 MHz @ -0.5 dBFS	54.3		53.8		dB
THD	Total Harmonic Distortion	A _{IN} = 125 MHz @ -0.5 dBFS	-68.3		-70.5		dB
		A _{IN} = 248 MHz @ -0.5 dBFS	-65.9		-67.8		dB
		A _{IN} = 498 MHz @ -0.5 dBFS	-68.5		-69.2		dB
		A _{IN} = 998 MHz @ -0.5 dBFS	-66.2		-64.5		dB
		A _{IN} = 1498 MHz @ -0.5 dBFS	-65.3		-64.6		dB
2nd Harm	Second Harmonic Distortion	A _{IN} = 125 MHz @ -0.5 dBFS	80.3		81.3		dBc
		A _{IN} = 248 MHz @ -0.5 dBFS	83.2		78.0		dBc
		A _{IN} = 498 MHz @ -0.5 dBFS	80.5		79.5		dBc
		A _{IN} = 998 MHz @ -0.5 dBFS	80.2		69.5		dBc
		A _{IN} = 1498 MHz @ -0.5 dBFS	71.8		75.1		dBc
3rd Harm	Third Harmonic Distortion	A _{IN} = 125 MHz @ -0.5 dBFS	72.5		75.1		dBc
		A _{IN} = 248 MHz @ -0.5 dBFS	68.8		72.4		dBc
		A _{IN} = 498 MHz @ -0.5 dBFS	76.1		73.8		dBc
		A _{IN} = 998 MHz @ -0.5 dBFS	68.1		67.8		dBc
		A _{IN} = 1498 MHz @ -0.5 dBFS	73.2		66.2		dBc
SFDR	Spurious-Free Dynamic Range	A _{IN} = 125 MHz @ -0.5 dBFS	71.9		74.3		dBc
		A _{IN} = 248 MHz @ -0.5 dBFS	67.6		70.4		dBc
		A _{IN} = 498 MHz @ -0.5 dBFS	68.8		70.3		dBc
		A _{IN} = 998 MHz @ -0.5 dBFS	66.2		67.3		dBc
		A _{IN} = 1498 MHz @ -0.5 dBFS	63.9		56.7		dBc

- (1) The Dynamic Specifications are ensured for room to hot ambient temperature only (25°C to 85°C). Refer to the plots of the dynamic performance vs. temperature in the [Typical Performance Plots](#) to see typical performance from cold to room temperature (-40°C to 25°C).
- (2) These measurements were taken in Extended Control Mode (ECM) with the DES Timing Adjust feature enabled (Addr: 7h). This feature is used to reduce the interleaving timing spur amplitude, which occurs at Fs/2-Fin, and thereby increase the SFDR, SINAD and ENOB.

3.6 Converter Electrical Characteristics Analog Input/Output and Reference Characteristics

Symbol	Parameter	Conditions	ADC12D800RF		ADC12D500RF		Units (Limits)
			Typ	Lim	Typ	Lim	
Analog Inputs							
V _{IN_FSR}	Analog Differential Input Full Scale Range	Non-Extended Control Mode					
		FSR Pin Low	600	530	600	530	mV _{P-P} (min)
				670		670	mV _{P-P} (max)
		FSR Pin High	800	730	800	730	mV _{P-P} (min)
				870		870	mV _{P-P} (max)
		Extended Control Mode					
		FM(14:0) = 0000h	600		600		mV _{P-P}
		FM(14:0) = 4000h (default)	800		800		mV _{P-P}
FM(14:0) = 7FFFh	1000		1000		mV _{P-P}		
C _{IN}	Analog Input Capacitance, Non-DES Mode ⁽¹⁾	Differential	0.02		0.02		pF
		Each input pin to ground	1.6		1.6		pF
	Analog Input Capacitance, DES Mode ⁽¹⁾	Differential	0.08		0.08		pF
		Each input pin to ground	2.2		2.2		pF
R _{IN}	Differential Input Resistance		100		100		Ω
Common Mode Output							
V _{CMO}	Common Mode Output Voltage	I _{CMO} = ±100 μA	1.25	1.15	1.25	1.15	V (min)
				1.35		1.35	V (max)
TC_V _{CMO}	Common Mode Output Voltage Temperature Coefficient	I _{CMO} = ±100 μA ⁽²⁾	38		38		ppm/°C
V _{CMO_LVL}	V _{CMO} input threshold to set DC-coupling Mode		0.63		0.63		V
C _{L_VCMO}	Maximum V _{CMO} Load Capacitance	See ⁽¹⁾		80		80	pF
Bandgap Reference							
V _{BG}	Bandgap Reference Output Voltage	I _{BG} = ±100 μA	1.25	1.15	1.25	1.15	V (min)
				1.35		1.35	V (max)
TC_V _{BG}	Bandgap Reference Voltage Temperature Coefficient	I _{BG} = ±100 μA ⁽²⁾	32		32		ppm/°C
C _{L_VBG}	Maximum Bandgap Reference load Capacitance	See ⁽¹⁾		80		80	pF

(1) This parameter is ensured by design and is not tested in production.

(2) This parameter is ensured by design and/or characterization and is not tested in production.

3.7 Converter Electrical Characteristics I-Channel to Q-Channel Characteristics

Symbol	Parameter	Conditions	ADC12D800RF		ADC12D500RF		Units (Limits)
			Typ	Lim	Typ	Lim	
	Offset Match	See ⁽¹⁾	2		2		LSB
	Positive Full-Scale Match	Zero offset selected in Control Register	2		2		LSB
	Negative Full-Scale Match	Zero offset selected in Control Register	2		2		LSB
	Phase Matching (I, Q)	$f_{IN} = 1.0 \text{ GHz}^{(2)}$	< 1		< 1		Degree
X-TALK	Crosstalk from I-channel (Aggressor) to Q-channel (Victim)	Aggressor = 867 MHz F.S. Victim = 100 MHz F.S. ⁽¹⁾	-70		-70		dB
	Crosstalk from Q-channel (Aggressor) to I-channel (Victim)	Aggressor = 867 MHz F.S. Victim = 100 MHz F.S. ⁽¹⁾	-70		-70		dB

(1) This parameter is ensured by design and/or characterization and is not tested in production.

(2) This parameter is ensured by design and is not tested in production.

3.8 Converter Electrical Characteristics Sampling Clock Characteristics

Symbol	Parameter	Conditions	ADC12D800RF		ADC12D500RF		Units (Limits)
			Typ	Lim	Typ	Lim	
V _{IN_CLK}	Differential Sampling Clock Input Level ⁽¹⁾	Sine Wave Clock Differential Peak-to-Peak	0.6	0.4	0.6	0.4	V _{P-P} (min)
				2.0		2.0	V _{P-P} (max)
		Square Wave Clock Differential Peak-to-Peak	0.6	0.4	0.6	0.4	V _{P-P} (min)
				2.0		2.0	V _{P-P} (max)
C _{IN_CLK}	Sampling Clock Input Capacitance ⁽²⁾	Differential	0.1		0.1		pF
		Each input to ground	1		1		pF
R _{IN_CLK}	Sampling Clock Differential Input Resistance	D.C.	100		100		Ω

(1) This parameter is ensured by design and/or characterization and is not tested in production.

(2) This parameter is ensured by design and is not tested in production.

3.9 Converter Electrical Characteristics AutoSync Feature Characteristics⁽¹⁾

Symbol	Parameter	Conditions	ADC12D800RF		ADC12D500RF		Units (Limits)
			Typ	Lim	Typ	Lim	
V _{IN_RCLK}	Differential RCLK Input Level	Differential Peak-to-Peak	360		360		mV _{P-P}
C _{IN_RCLK}	RCLK Input Capacitance	Differential	0.1		0.1		pF
		Each input to ground	1		1		pF
R _{IN_RCLK}	RCLK Differential Input Resistance		100		100		Ω
I _{IH_RCLK}	Input Leakage Current; V _{IN} = V _A		22		22		μA
I _{IL_RCLK}	Input Leakage Current; V _{IN} = GND		-33		-33		μA
V _{O_RCOU}	Differential RCOU Output Voltage		360		360		mV _{P-P}

(1) This feature functionality is not tested in production test; performance is tested in the specified/default mode only.

3.10 Converter Electrical Characteristics Digital Control and Output Pin Characteristics

Symbol	Parameter	Conditions	ADC12D800RF		ADC12D500RF		Units (Limits)
			Typ	Lim	Typ	Lim	
Digital Control Pins (DES, CalDIy, CAL, PDI, PDQ, TPM, NDM, FSR, DDRPh, \overline{ECE}, SCLK, SDI, \overline{SCS})							
V _{IH}	Logic High Input Voltage			0.7×V _A		0.7×V _A	V (min)
V _{IL}	Logic Low Input Voltage			0.3×V _A		0.3×V _A	V (max)
I _{IH}	Input Leakage Current; V _{IN} = V _A		0.02		0.02		μA
I _{IL}	Input Leakage Current; V _{IN} = GND	FSR, CalDIy, CAL, NDM, TPM, DDRPh, DES	-0.02		-0.02		μA
		\overline{SCS} , SCLK, SDI	-17		-17		μA
		PDI, PDQ, \overline{ECE}	-38		-38		μA
Digital Output Pins (Data, DCLKI, DCLKQ, ORI, ORQ)							
V _{OD}	LVDS Differential Output Voltage	V _{BG} = Floating, OVS = High	630	400	630	400	mV _{P-P} (min)
				800		800	mV _{P-P} (max)
		V _{BG} = Floating, OVS = Low	460	230	460	230	mV _{P-P} (min)
				630		630	mV _{P-P} (max)
		V _{BG} = V _A , OVS = High ⁽¹⁾	670		670		mV _{P-P}
V _{BG} = V _A , OVS = Low ⁽¹⁾	500		500		mV _{P-P}		
ΔV _{O DIFF}	Change in LVDS Output Swing Between Logic Levels		±1		±1		mV
V _{OS}	Output Offset Voltage	V _{BG} = Floating ⁽¹⁾	0.8		0.8		V
		V _{BG} = V _A ⁽¹⁾	1.2		1.2		V
ΔV _{OS}	Output Offset Voltage Change Between Logic Levels	See ⁽¹⁾	±1		±1		mV
I _{OS}	Output Short Circuit Current	V _{BG} = Floating; D+ and D- connected to 0.8V ⁽¹⁾	±4		±4		mA
Z _O	Differential Output Impedance	See ⁽¹⁾	100		100		Ω
V _{OH}	Logic High Output Level	CalRun, I _{OH} = -100 μA, SDO, I _{OH} = -400 μA ⁽¹⁾	1.65		1.65		V
V _{OL}	Logic Low Output Level	CalRun, I _{OL} = 100 μA, SDO, I _{OL} = 400 μA ⁽¹⁾	0.15		0.15		V
Differential DCLK Reset Pins (DCLK_RST)⁽²⁾							
V _{CMI_DRST}	DCLK_RST Common Mode Input Voltage		1.25		1.25		V
V _{ID_DRST}	Differential DCLK_RST Input Voltage		V _{IN_CLK}		V _{IN_CLK}		V _{P-P}
R _{IN_DRST}	Differential DCLK_RST Input Resistance	See ⁽³⁾	100		100		Ω

(1) This parameter is ensured by design and/or characterization and is not tested in production.

(2) This feature functionality is not tested in production test; performance is tested in the specified/default mode only.

(3) This parameter is ensured by design and is not tested in production.

3.11 Converter Electrical Characteristics Power Supply Characteristics

Symbol	Parameter	Conditions	ADC12D800RF		ADC12D500RF		Units (Limits)
			Typ	Lim	Typ	Lim	
I _A	Analog Supply Current	PDI = PDQ = Low	755		589		mA
		PDI = Low; PDQ = High	422		340		mA
		PDI = High; PDQ = Low	422		340		mA
		PDI = PDQ = High	2.4		2.4		mA
I _{TC}	Track-and-Hold and Clock Supply Current	PDI = PDQ = Low	343		295		mA
		PDI = Low; PDQ = High	213		184		mA
		PDI = High; PDQ = Low	213		184		mA
		PDI = PDQ = High	560		560		μA
I _{DR}	Output Driver Supply Current	PDI = PDQ = Low	161		148		mA
		PDI = Low; PDQ = High	90		81		mA
		PDI = High; PDQ = Low	90		81		mA
		PDI = PDQ = High	4		4		μA
I _E	Digital Encoder Supply Current	PDI = PDQ = Low	55		30		mA
		PDI = Low; PDQ = High	30		14		mA
		PDI = High; PDQ = Low	30		14		mA
		PDI = PDQ = High	2.1		2.1		μA
I _{TOTAL}	Total Supply Current	1:2 Demux Mode PDI = PDQ = Low	1415		1208		mA
		Non-Demux Mode PDI = PDQ = Low	1314	1670	1062	1359	mA (max)
P _C	Power Consumption	Non-Demux Mode					
		PDI = PDQ = Low	2.50	3.17	2.02	2.58	W (max)
		PDI = Low; PDQ = High	1.43		1.18		W
		PDI = High; PDQ = Low	1.43		1.18		W
		PDI = PDQ = High	5.6		5.6		mW
		1:2 Demux Mode PDI = PDQ = Low	2.69		2.30		W

3.12 Converter Electrical Characteristics AC Electrical Characteristics

Symbol	Parameter	Conditions	ADC12D800RF		ADC12D500RF		Units (Limits)
			Typ	Lim	Typ	Lim	
Sampling Clock (CLK)							
f _{CLK (max)}	Maximum Sampling Clock Frequency			800		500	MHz
f _{CLK (min)}	Minimum Sampling Clock Frequency	Non-DES Mode ⁽¹⁾		150		150	MHz
		DES Mode ⁽¹⁾		200		200	MHz
	Sampling Clock Duty Cycle	f _{CLK(min)} ≤ f _{CLK} ≤ f _{CLK(max)} ⁽¹⁾	50	20	50	20	% (min)
				80		80	% (max)
t _{CL}	Sampling Clock Low Time	See ⁽¹⁾	625	250	1000	400	ps (min)
t _{CH}	Sampling Clock High Time	See ⁽²⁾	625	250	1000	400	ps (min)

(1) This parameter is ensured by design and/or characterization and is not tested in production.

(2) This parameter is ensured by design and is not tested in production.

Converter Electrical Characteristics
AC Electrical Characteristics (continued)

Symbol	Parameter	Conditions	ADC12D800RF		ADC12D500RF		Units (Limits)
			Typ	Lim	Typ	Lim	
Data Clock (DCLKI, DCLKQ)							
	DCLK Duty Cycle	See ⁽¹⁾	50	45 55	50	45 55	% (min) % (max)
t _{SR}	Setup Time DCLK_RST±	see ⁽²⁾	45		45		ps
t _{HR}	Hold Time DCLK_RST±	See ⁽²⁾	45		45		ps
t _{PWR}	Pulse Width DCLK_RST±	See ⁽¹⁾		5		5	Sampling Clock Cycles (min)
t _{SYNC_DLY}	DCLK Synchronization Delay	90° Mode ⁽¹⁾		4		4	Sampling Clock Cycles
		0° Mode ⁽¹⁾		5		5	
t _{LHT}	Differential Low-to-High Transition Time	10%-to-90%, C _L = 2.5 pF ⁽²⁾	220		220		ps
t _{HHT}	Differential High-to-Low Transition Time	10%-to-90%, C _L = 2.5 pF ⁽²⁾	220		220		ps
t _{SU}	Data-to-DCLK Setup Time	DDR 90° Mode ⁽²⁾	525		900		ps
t _H	DCLK-to-Data Hold Time	DDR 90° Mode ⁽²⁾	525		900		ps
t _{OSK}	DCLK-to-Data Output Skew	50% of DCLK transition to 50% of Data transition DDR 0° Mode, SDR Mode ⁽²⁾	±50		±50		ps
Data Input-to-Output							
t _{AD}	Aperture Delay	Sampling CLK+ Rise to Acquisition of Data ⁽²⁾	1.22		1.22		ns
t _{AJ}	Aperture Jitter	See ⁽²⁾	0.2		0.2		ps (rms)
t _{OD}	Sampling Clock-to Data Output Delay (in addition to Latency)	50% of Sampling Clock transition to 50% of Data transition ⁽²⁾	3.15		3.15		ns
t _{LAT}	Latency in 1:2 Demux Non-DES Mode ⁽¹⁾	DI, DQ Outputs		17.5		17.5	Sampling Clock Cycles
		DId, DQd Outputs		18.5		18.5	
	Latency in 1:4 Demux DES Mode ⁽¹⁾	DI Outputs		17.5		17.5	
		DQ Outputs		18		18	
		DId Outputs		18.5		18.5	
	Latency in Non-Demux Non-DES Mode ⁽¹⁾	DQd Outputs		19		19	
		DI Outputs		17		17	
	Latency in Non-Demux DES Mode ⁽¹⁾	DQ Outputs		17		17	
DI Outputs			17		17		
t _{ORR}	Over Range Recovery Time	Differential V _{IN} step from ±1.2V to 0V to accurate conversion ⁽¹⁾	1		1		Sampling Clock Cycle
t _{WU}	Wake-Up Time (PDI/PDQ low to Rated Accuracy Conversion)	Non-DES Mode ⁽¹⁾	500		500		ns
		DES Mode ⁽¹⁾	1		1		µs

(1) This parameter is ensured by design and is not tested in production.
(2) This parameter is ensured by design and/or characterization and is not tested in production.

3.13 Converter Electrical Characteristics Serial Port Interface

Symbol	Parameter	Conditions	ADC12D800RF		ADC12D500RF		Units (Limits)
			Typ	Lim	Typ	Lim	
f_{SCLK}	Serial Clock Frequency	See ⁽¹⁾	15		15		MHz
	Serial Clock Low Time			30		30	ns (min)
	Serial Clock High Time			30		30	ns (min)
t_{SSU}	Serial Data-to-Serial Clock Rising Setup Time	See ⁽¹⁾	2.5		2.5		ns (min)
t_{SH}	Serial Data-to-Serial Clock Rising Hold Time	See ⁽¹⁾	1		1		ns (min)
t_{SCS}	\overline{SCS} -to-Serial Clock Rising Setup Time		2.5		2.5		ns
t_{HCS}	\overline{SCS} -to-Serial Clock Falling Hold Time		1.5		1.5		ns
t_{BSU}	Bus turn-around time		10		10		ns

(1) This parameter is ensured by design and is not tested in production.

3.14 Converter Electrical Characteristics Calibration

Symbol	Parameter	Conditions	ADC12D800RF		ADC12D500RF		Units (Limits)
			Typ	Lim	Typ	Lim	
t_{CAL}	Calibration Cycle Time	See ⁽¹⁾	$2 \cdot 10^7$		$2 \cdot 10^7$		Sampling Clock Cycles
t_{CAL_L}	CAL Pin Low Time	See ⁽¹⁾		640		640	Sampling Clock Cycles (min)
t_{CAL_H}	CAL Pin High Time	See ⁽¹⁾		640		640	
t_{CalDly}	Calibration delay determined by CalDly Pin	CalDly = Low ⁽¹⁾		2²³		2²³	Sampling Clock Cycles (max)
		CalDly = High ⁽¹⁾		2²⁹		2²⁹	

(1) This parameter is ensured by design and is not tested in production.

4 Specification Definitions

APERTURE (SAMPLING) DELAY is the amount of delay, measured from the sampling edge of the CLK input, after which the signal present at the input pin is sampled inside the device.

APERTURE JITTER (t_{AJ}) is the variation in aperture delay from sample-to-sample. Aperture jitter can be effectively considered as noise at the input.

CODE ERROR RATE (CER) is the probability of error and is defined as the probable number of word errors on the ADC output per unit of time divided by the number of words seen in that amount of time. A CER of 10^{-18} corresponds to a statistical error in one word about every 31.7 years for the ADC12D800RF.

CLOCK DUTY CYCLE is the ratio of the time that the clock waveform is at a logic high to the total time of one clock period.

DIFFERENTIAL NON-LINEARITY (DNL) is the measure of the maximum deviation from the ideal step size of 1 LSB. It is measured at the relevant sample rate, f_{CLK} , with $f_{IN} = 1$ MHz sine wave.

EFFECTIVE NUMBER OF BITS (ENOB, or EFFECTIVE BITS) is another method of specifying Signal-to-Noise and Distortion Ratio, or SINAD. ENOB is defined as $(SINAD - 1.76) / 6.02$ and states that the converter is equivalent to a perfect ADC of this many (ENOB) number of bits.

GAIN ERROR is the deviation from the ideal slope of the transfer function. It can be calculated from Offset and Full-Scale Errors. The Positive Gain Error is the Offset Error minus the Positive Full-Scale Error. The Negative Gain Error is the Negative Full-Scale Error minus the Offset Error. The Gain Error is the Negative Full-Scale Error minus the Positive Full-Scale Error; it is also equal to the Positive Gain Error plus the Negative Gain Error.

GAIN FLATNESS is a measure of the variation in gain over the specified bandwidth. For example, for the ADC12D800RF, from D.C. to $F_s/2$ is to 400 MHz for the Non-DES Mode and from D.C to $F_s/2$ is to 800 MHz for the DES Mode.

INTEGRAL NON-LINEARITY (INL) is a measure of worst case deviation of the ADC transfer function from an ideal straight line drawn through the ADC transfer function. The deviation of any given code from this straight line is measured from the center of that code value step. The best fit method is used.

INSERTION LOSS is the loss in power of a signal due to the insertion of a device, e.g. the ADC12D800/500RF, expressed in dB.

INTERMODULATION DISTORTION (IMD) is measure of the near-in 3rd order distortion products ($2f_2 - f_1$, $2f_1 - f_2$) which occur when two tones which are close in frequency (f_1 , f_2) are applied to the ADC input. It is measured from the input tones power of the higher of the two distortion products (dBFS). The input tones are typically -7dBFS.

LSB (LEAST SIGNIFICANT BIT) is the bit that has the smallest value or weight of all bits. This value is

$$V_{FS} / 2^N$$

where V_{FS} is the differential full-scale amplitude V_{IN_FSR} as set by the FSR input and "N" is the ADC resolution in bits, which is 10 for the ADC12D800/500RF.

LOW VOLTAGE DIFFERENTIAL SIGNALING (LVDS) DIFFERENTIAL OUTPUT VOLTAGE (V_{ID} and V_{OD}) is two times the absolute value of the difference between the V_{D+} and V_{D-} signals; each signal measured with respect to Ground. V_{OD} peak is $V_{OD,P} = (V_{D+} - V_{D-})$ and V_{OD} peak-to-peak is $V_{OD,P-P} = 2 * (V_{D+} - V_{D-})$; for this product, the V_{OD} is measured peak-to-peak.

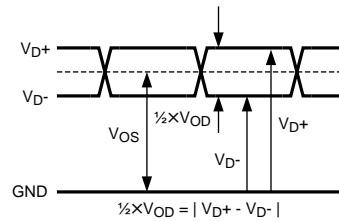
Figure 4-1. LVDS Output Signal Levels

LVDS OUTPUT OFFSET VOLTAGE (V_{OS}) is the midpoint between the D+ and D- pins output voltage with respect to ground; i.e., $[(V_{D+}) + (V_{D-})]/2$. See [Figure 4-1](#).

MISSING CODES are those output codes that are skipped and will never appear at the ADC outputs. These codes cannot be reached with any input value.

MSB (MOST SIGNIFICANT BIT) is the bit that has the largest value or weight. Its value is one half of full scale.

NEGATIVE FULL-SCALE ERROR (NFSE) is a measure of how far the first code transition is from the ideal $1/2$ LSB above a differential $-V_{IN}/2$ with the FSR pin low. For the ADC12D800/500RF the reference voltage is assumed to be ideal, so this error is a combination of full-scale error and reference voltage error.

NOISE FLOOR DENSITY is a measure of the power density of the noise floor, expressed in dBFS/Hz and dBm/Hz. '0 dBFS' is defined as the power of a sinusoid which precisely uses the full-scale range of the ADC.

NOISE POWER RATIO (NPR) is the ratio of the sum of the power inside the notched bins to the sum of the power in an equal number of bins outside the notch, expressed in dB.

OFFSET ERROR (V_{OFF}) is a measure of how far the mid-scale point is from the ideal zero voltage differential input.

Offset Error = Actual Input causing average of 8k samples to result in an average code of 2047.5.

OUTPUT DELAY (t_{OD}) is the time delay (in addition to Latency) after the rising edge of CLK+ before the data update is present at the output pins.

OVER-RANGE RECOVERY TIME is the time required after the differential input voltages goes from $\pm 1.2V$ to 0V for the converter to recover and make a conversion with its rated accuracy.

PIPELINE DELAY (LATENCY) is the number of input clock cycles between initiation of conversion and when that data is presented to the output driver stage. The data lags the conversion by the Latency plus the t_{OD} .

POSITIVE FULL-SCALE ERROR (PFSE) is a measure of how far the last code transition is from the ideal $1-1/2$ LSB below a differential $+V_{IN}/2$. For the ADC12D800/500RF the reference voltage is assumed to be ideal, so this error is a combination of full-scale error and reference voltage error.

SIGNAL TO NOISE RATIO (SNR) is the ratio, expressed in dB, of the rms value of the fundamental for a single-tone to the rms value of the sum of all other spectral components below one-half the sampling frequency, not including harmonics or DC.

SIGNAL TO NOISE PLUS DISTORTION (S/(N+D) or SINAD) is the ratio, expressed in dB, of the rms value of the fundamental for a single-tone to the rms value of all of the other spectral components below half the input clock frequency, including harmonics but excluding DC.

SPURIOUS-FREE DYNAMIC RANGE (SFDR) is the difference, expressed in dB, between the rms values of the input signal at the output and the peak spurious signal, where a spurious signal is any signal present in the output spectrum that is not present at the input, excluding DC.

θ_{JA} is the thermal resistance between the junction to ambient.

θ_{JC1} represents the thermal resistance between the die and the exposed metal area on the top of the HSBGA package.

θ_{JC2} represents the thermal resistance between the die and the center group of balls on the bottom of the HSBGA package.

TOTAL HARMONIC DISTORTION (THD) is the ratio expressed in dB, of the rms total of the first nine harmonic levels at the output to the level of the fundamental at the output. THD is calculated as

$$THD = 20 \times \log \sqrt{\frac{A_{f2}^2 + \dots + A_{f10}^2}{A_{f1}^2}}$$

where A_{f1} is the RMS power of the fundamental (output) frequency and A_{f2} through A_{f10} are the RMS power of the first 9 harmonic frequencies in the output spectrum.

- **Second Harmonic Distortion (2nd Harm)** is the difference, expressed in dB, between the RMS power in the input frequency seen at the output and the power in its 2nd harmonic level at the output.
- **Third Harmonic Distortion (3rd Harm)** is the difference expressed in dB between the RMS power in the input frequency seen at the output and the power in its 3rd harmonic level at the output.

4.1 Transfer Characteristic

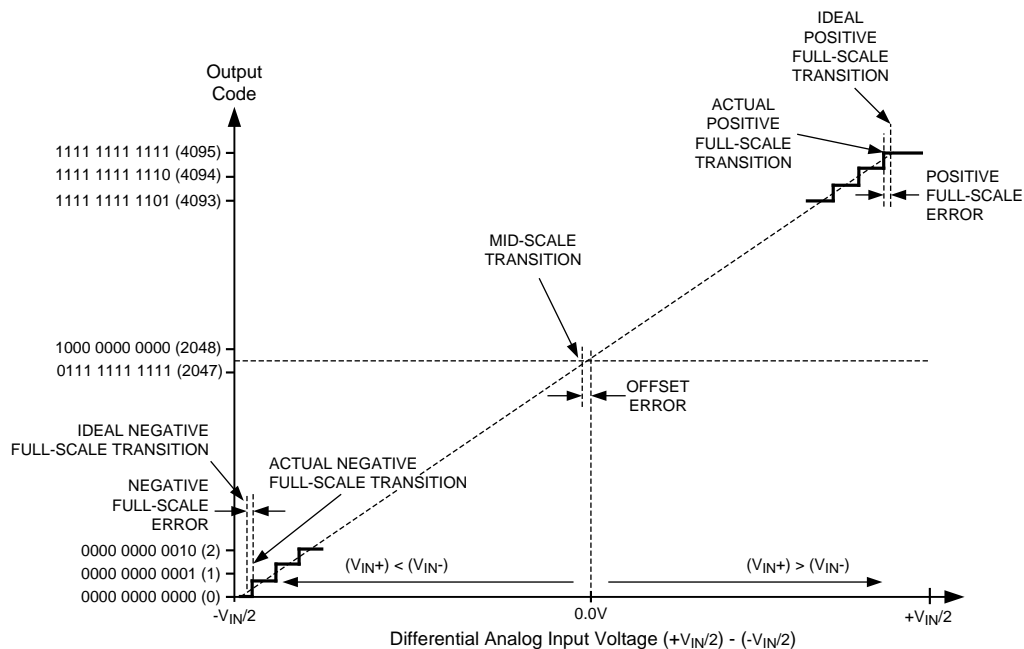

Figure 4-2. Input / Output Transfer Characteristic

4.2 Timing Diagrams

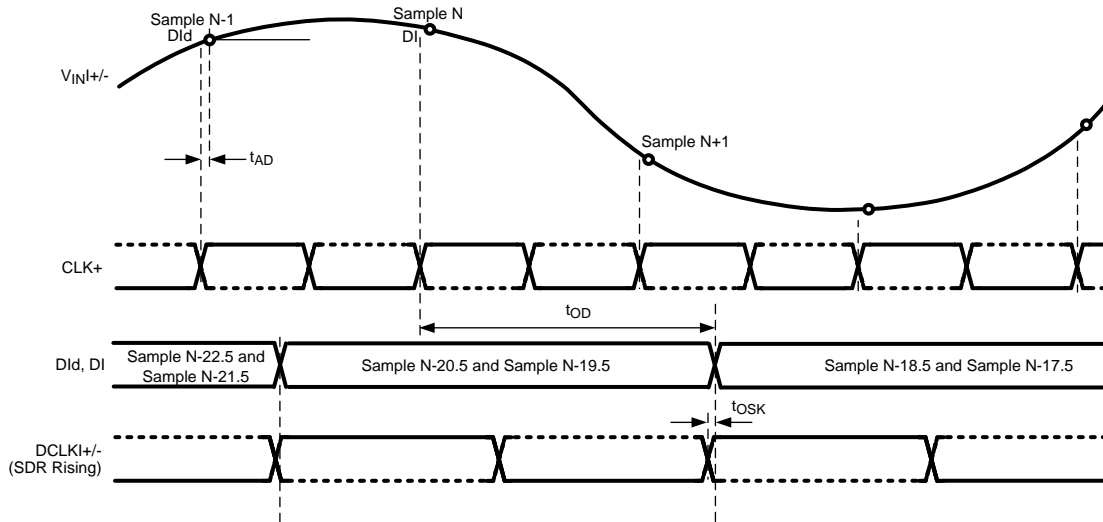

Figure 4-3. Clocking in 1:2 Demux Non-DES Mode*

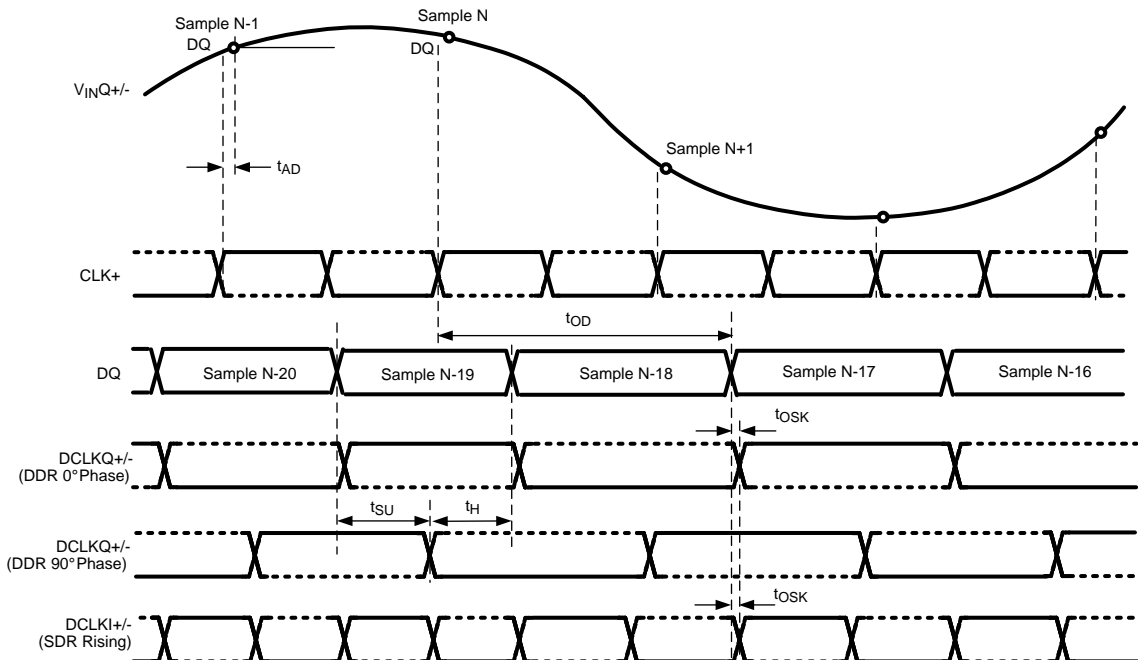

Figure 4-4. Clocking in Non-Demux Non-DES Mode*

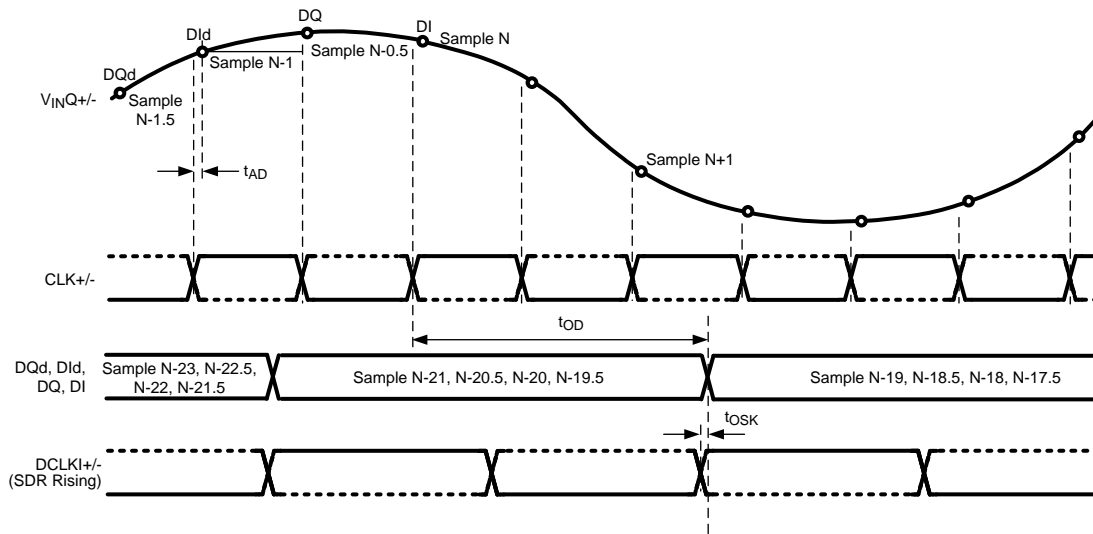

Figure 4-5. Clocking in 1:4 Demux DES Mode*

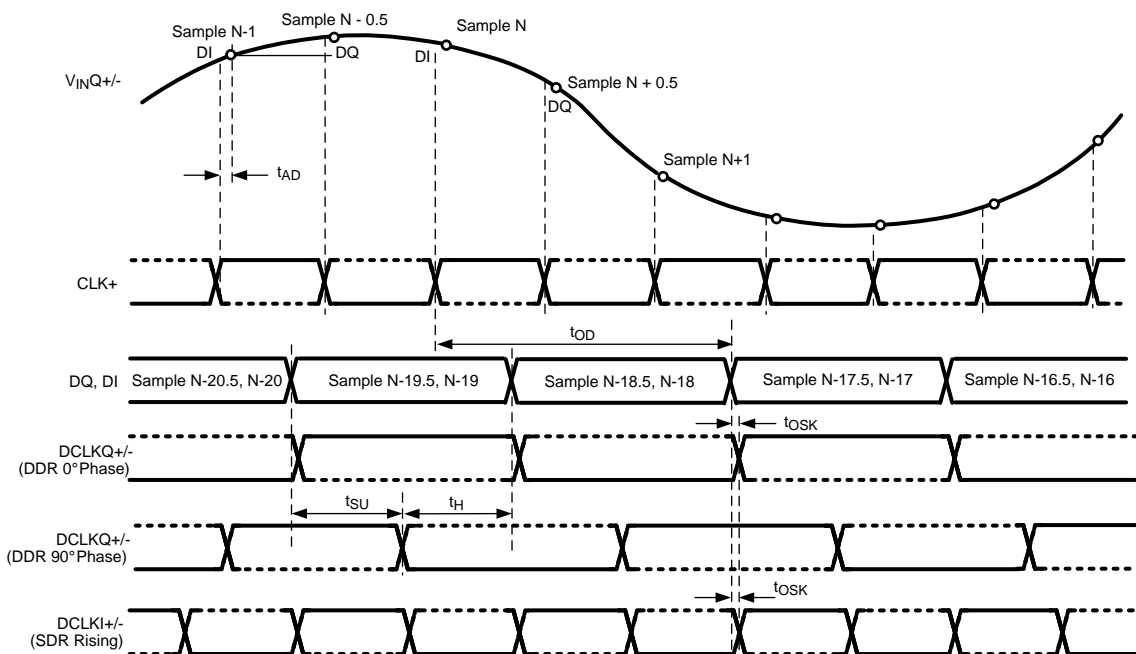

Figure 4-6. Clocking in Non-Demux Mode DES Mode*

NOTE

* The timing for these figures is shown for the one input only (I or Q). However, both I- and Q-inputs may be used. For this case, the I-channel functions precisely the same as the Q-channel, with VinI, DCLKI, DI and DI instead of VinQ, DCLKQ, DQd and DQ. Both I- and Q-channel use the same CLK.

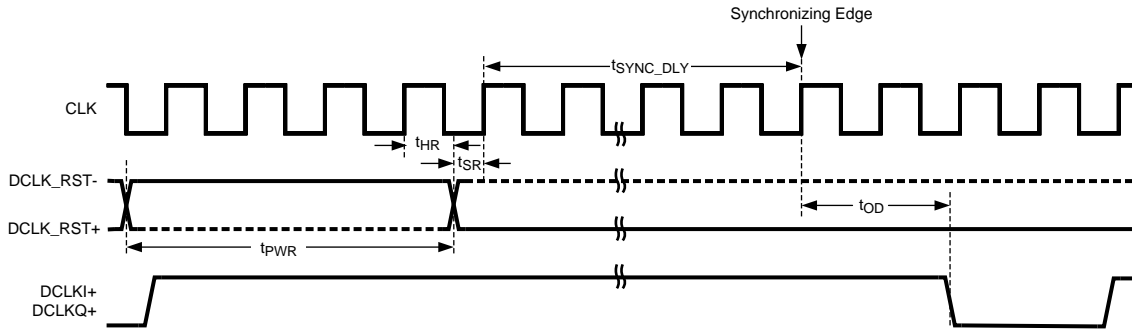

Figure 4-7. Data Clock Reset Timing (Demux Mode)

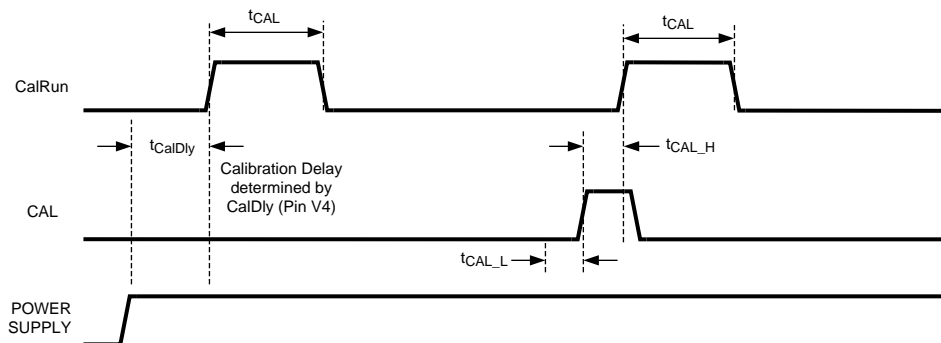

Figure 4-8. Power-on and On-Command Calibration Timing

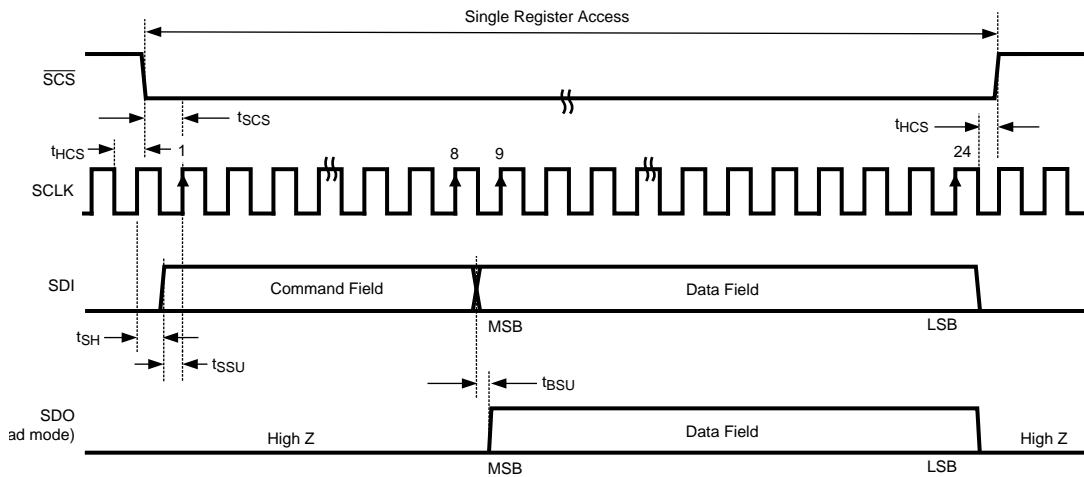

Figure 4-9. Serial Interface Timing

5 Typical Performance Plots

$V_A = V_{DR} = V_{TC} = V_E = 1.9V$, $f_{CLK} = 800\text{ MHz} / 500\text{ MHz}$ for the ADC12D800RF / ADC12D500RF, respectively, $f_{IN} = 498\text{ MHz}$, $T_A = 25^\circ\text{C}$, I-channel, Non-Demux Non-DES Mode, unless otherwise stated.

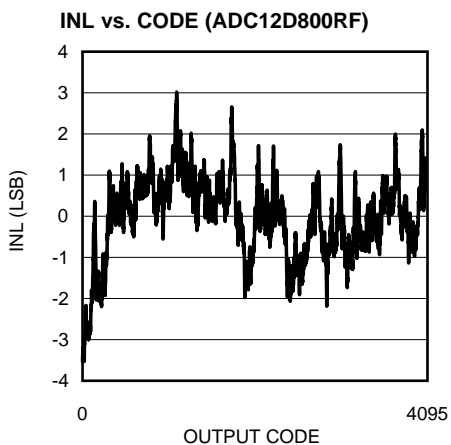

Figure 5-1.

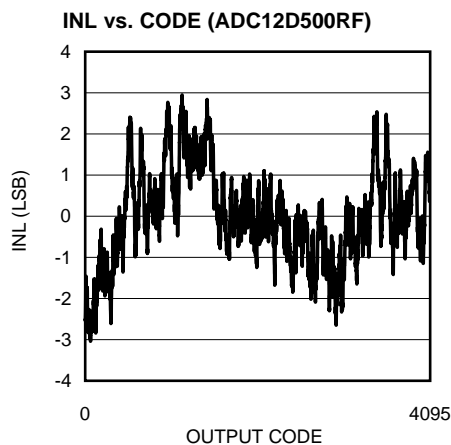

Figure 5-2.

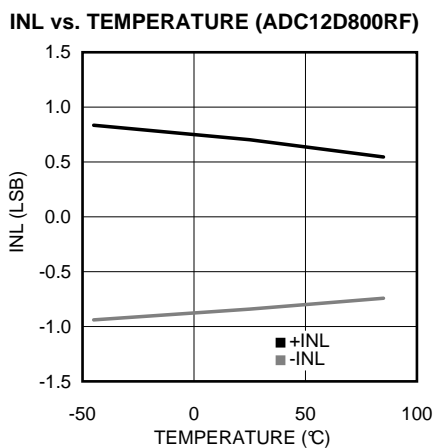

Figure 5-3.

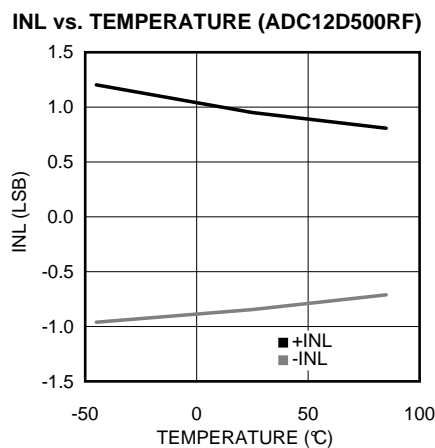

Figure 5-4.

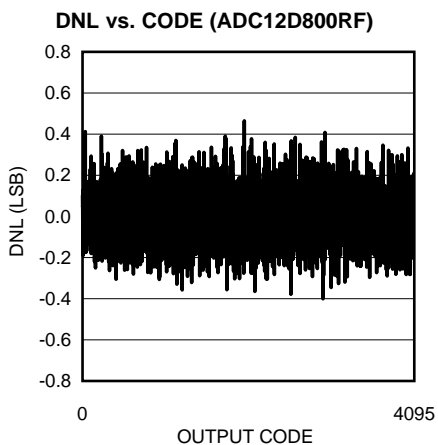

Figure 5-5.

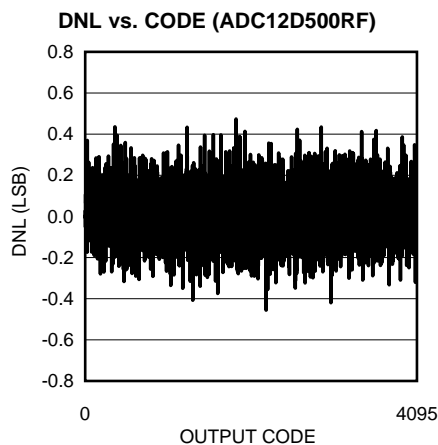

Figure 5-6.

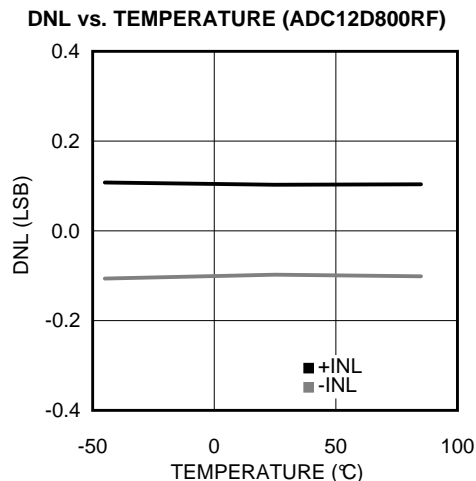

Figure 5-7.

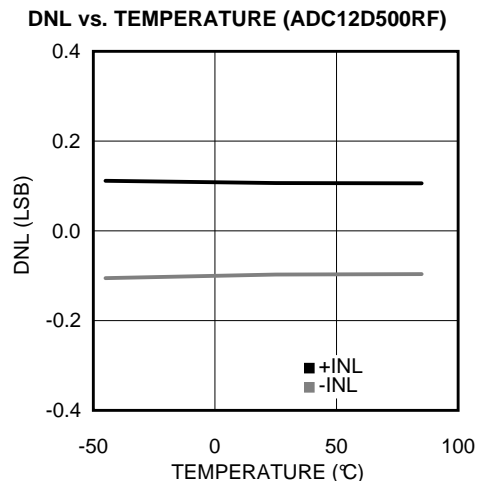

Figure 5-8.

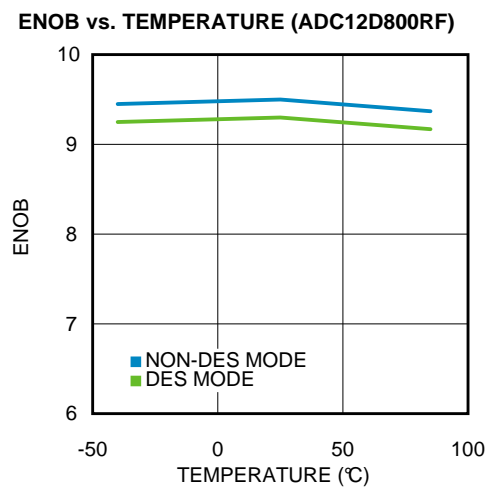

Figure 5-9.

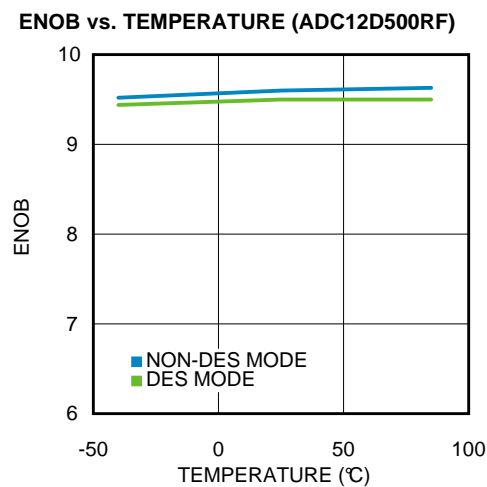

Figure 5-10.

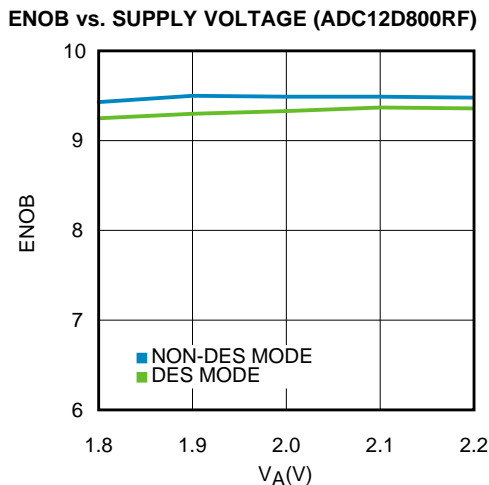

Figure 5-11.

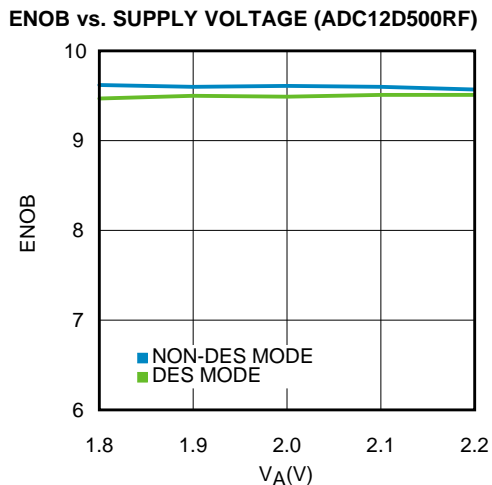

Figure 5-12.

ENOB vs. CLOCK FREQUENCY (ADC12D800RF)

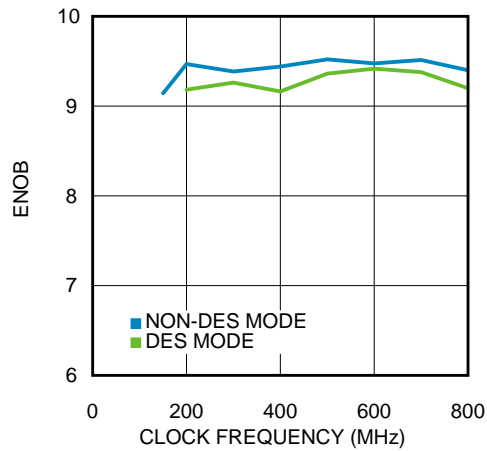

Figure 5-13.

ENOB vs. CLOCK FREQUENCY (ADC12D500RF)

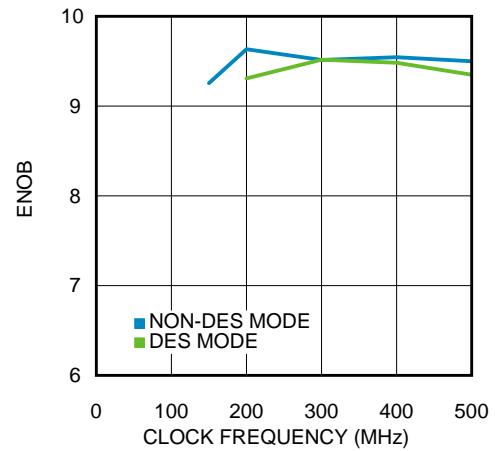

Figure 5-14.

ENOB vs. INPUT FREQUENCY (ADC12D800RF)

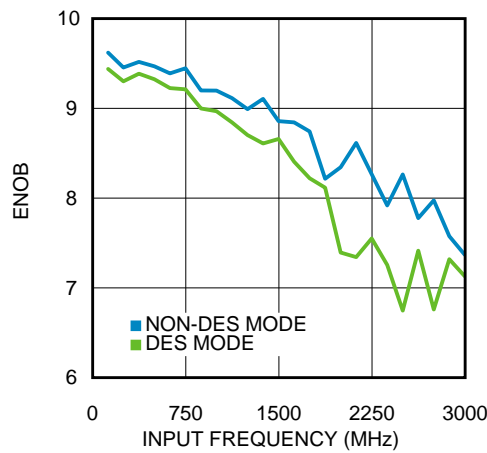

Figure 5-15.

ENOB vs. INPUT FREQUENCY (ADC12D500RF)

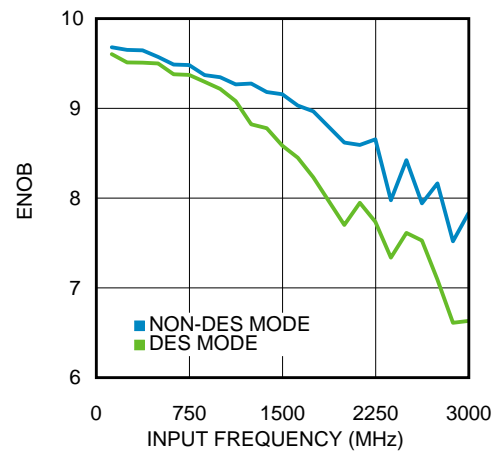

Figure 5-16.

ENOB vs. V_{CM1} (ADC12D800RF)

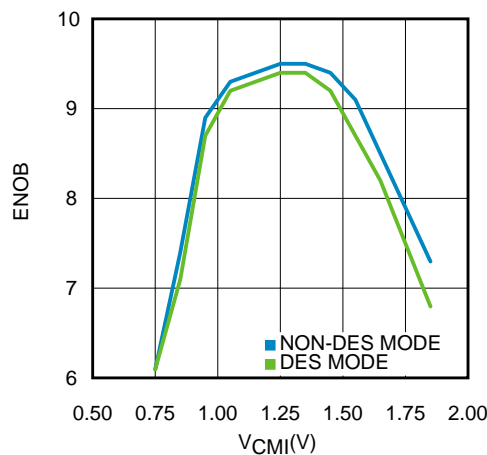

Figure 5-17.

ENOB vs. V_{CM1} (ADC12D500RF)

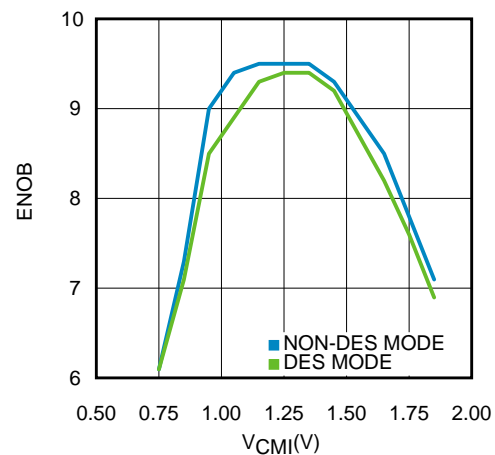

Figure 5-18.

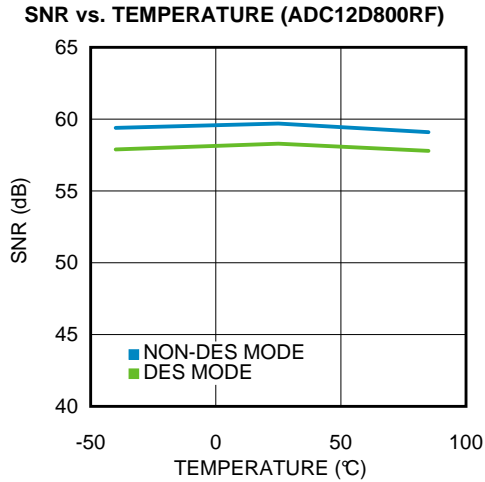

Figure 5-19.

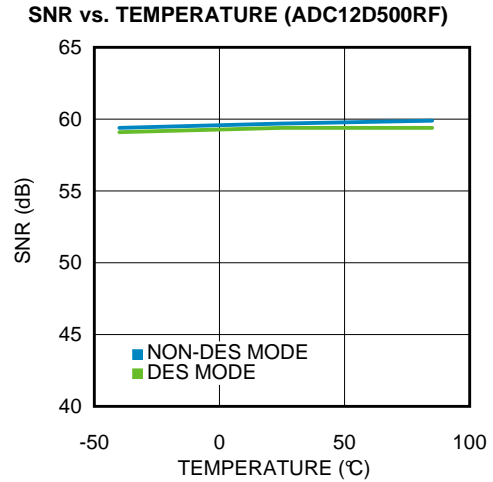

Figure 5-20.

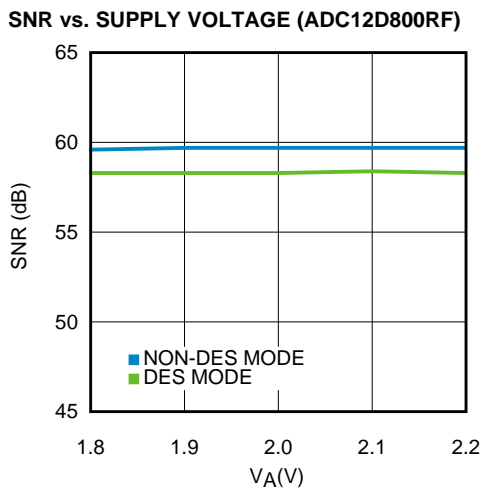

Figure 5-21.

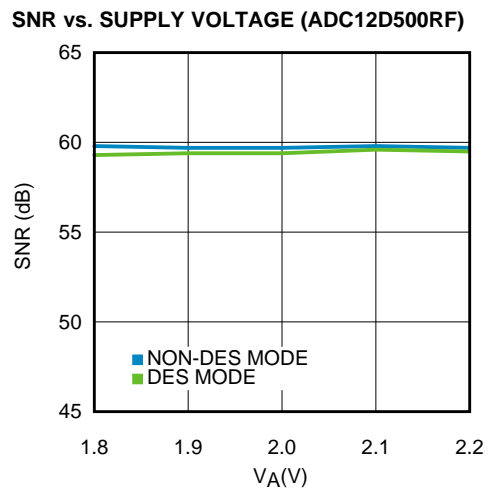

Figure 5-22.

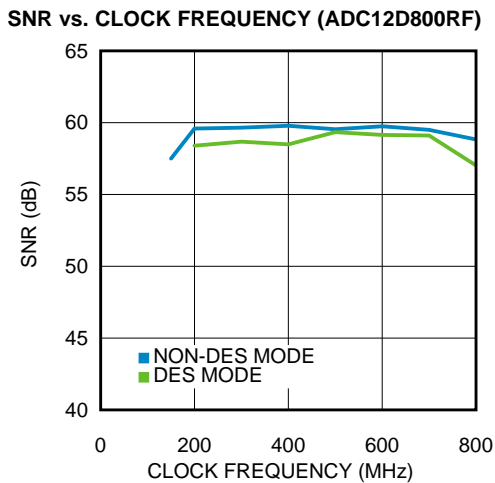

Figure 5-23.

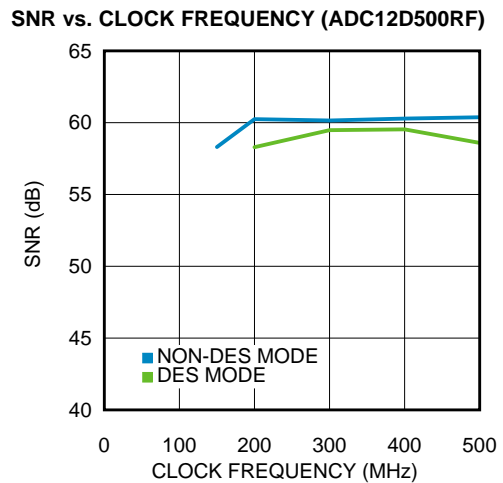

Figure 5-24.

SNR vs. INPUT FREQUENCY (ADC12D800RF)

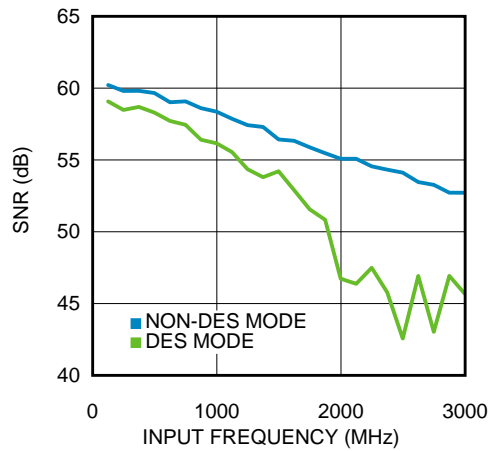

Figure 5-25.

SNR vs. INPUT FREQUENCY (ADC12D500RF)

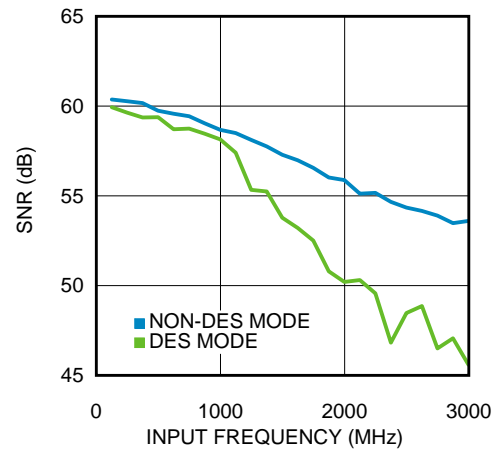

Figure 5-26.

THD vs. TEMPERATURE (ADC12D800RF)

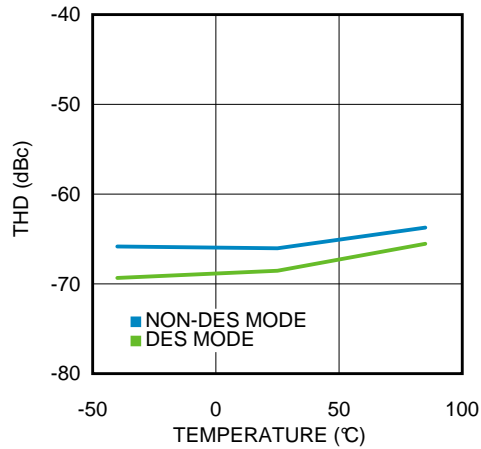

Figure 5-27.

THD vs. TEMPERATURE (ADC12D500RF)

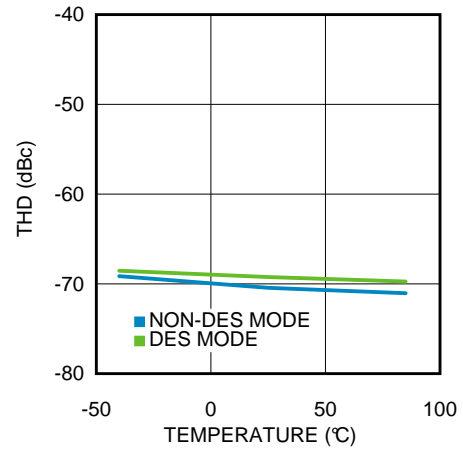

Figure 5-28.

THD vs. SUPPLY VOLTAGE (ADC12D800RF)

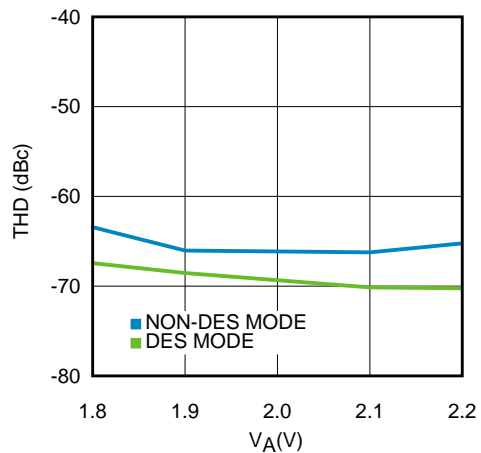

Figure 5-29.

THD vs. SUPPLY VOLTAGE (ADC12D500RF)

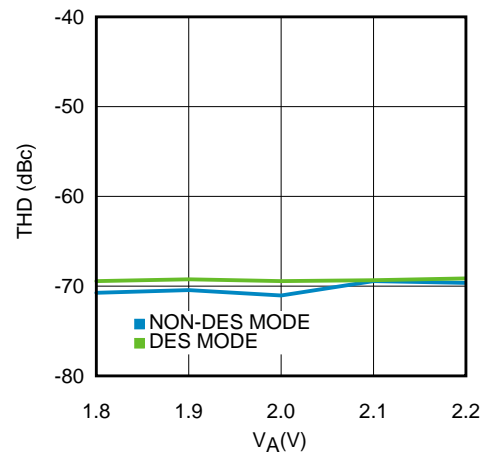

Figure 5-30.

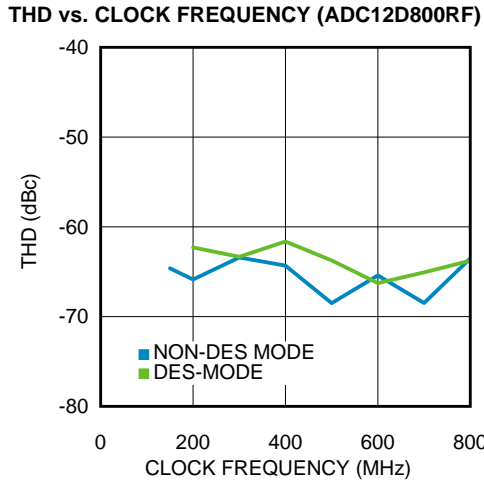

Figure 5-31.

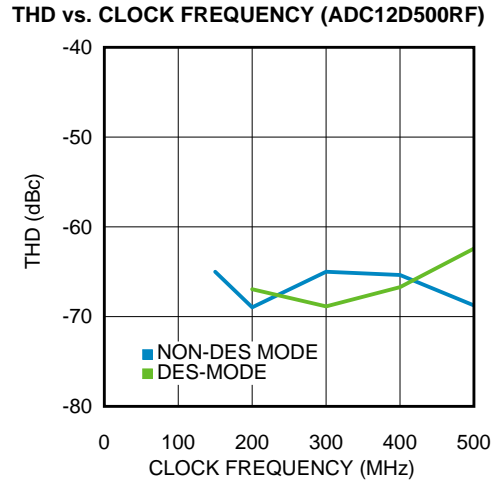

Figure 5-32.

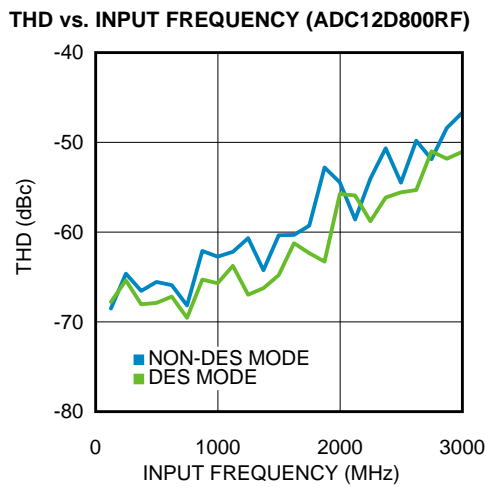

Figure 5-33.

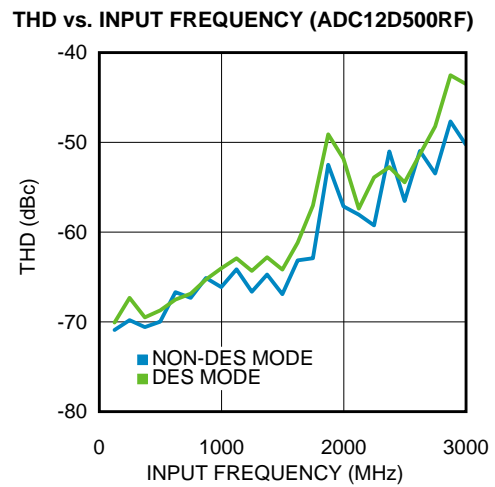

Figure 5-34.

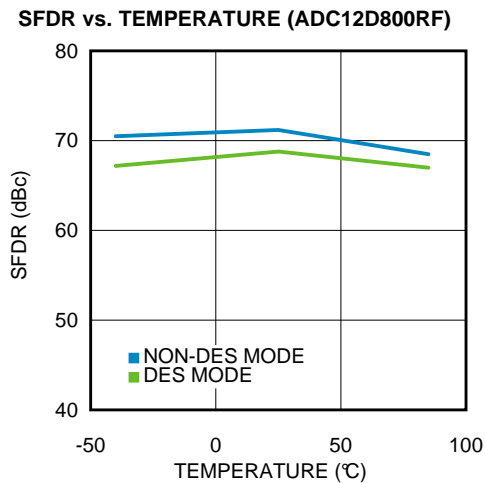

Figure 5-35.

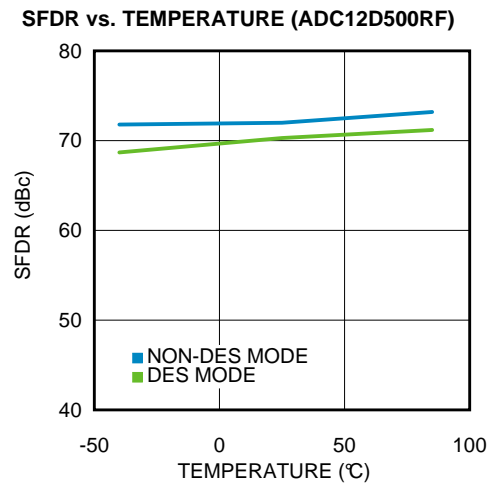

Figure 5-36.

SFDR vs. SUPPLY VOLTAGE (ADC12D800RF)

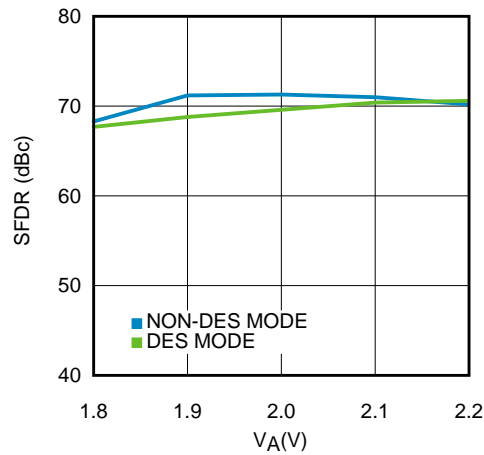

Figure 5-37.

SFDR vs. SUPPLY VOLTAGE (ADC12D500RF)

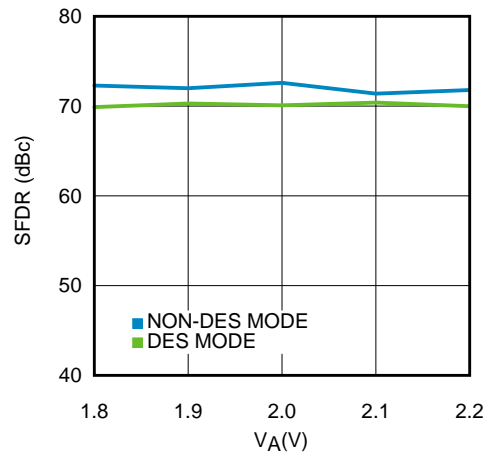

Figure 5-38.

SFDR vs. CLOCK FREQUENCY (ADC12D800RF)

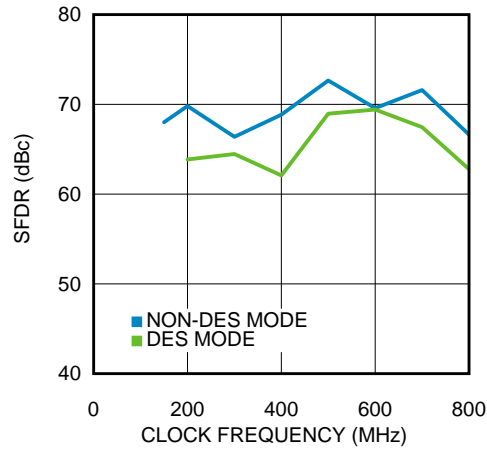

Figure 5-39.

SFDR vs. CLOCK FREQUENCY (ADC12D500RF)

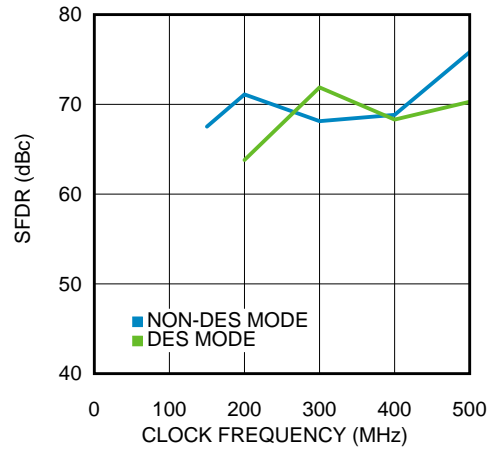

Figure 5-40.

SFDR vs. INPUT FREQUENCY (ADC12D800RF)

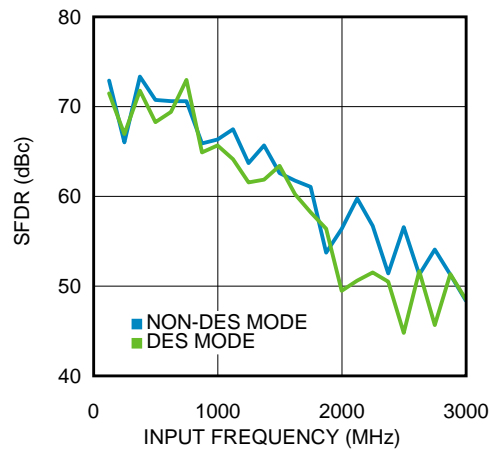

Figure 5-41.

SFDR vs. INPUT FREQUENCY (ADC12D500RF)

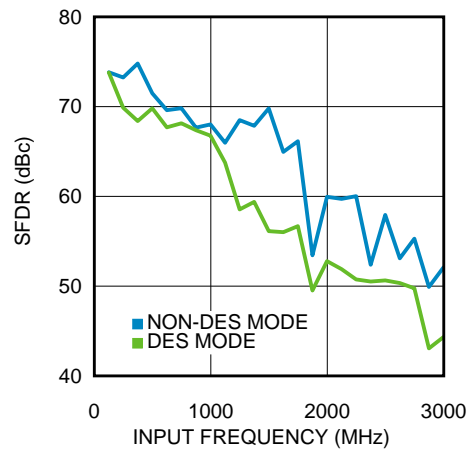

Figure 5-42.

SPECTRAL RESPONSE AT FIN = 498 MHz (ADC12D800RF)

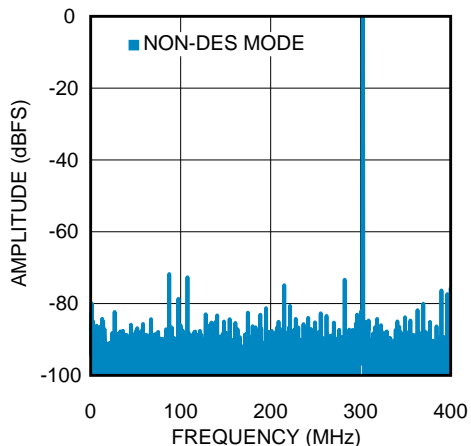

Figure 5-43.

SPECTRAL RESPONSE AT FIN = 498 MHz (ADC12D500RF)

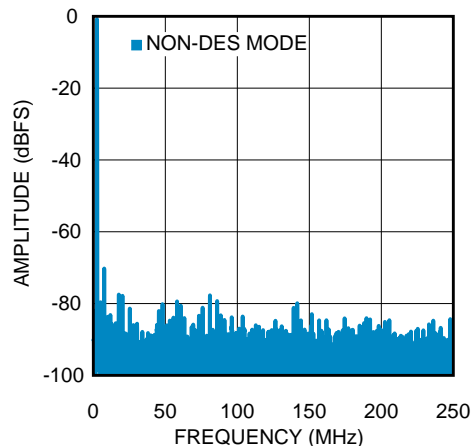

Figure 5-44.

SPECTRAL RESPONSE AT FIN = 498 MHz (ADC12D800RF)

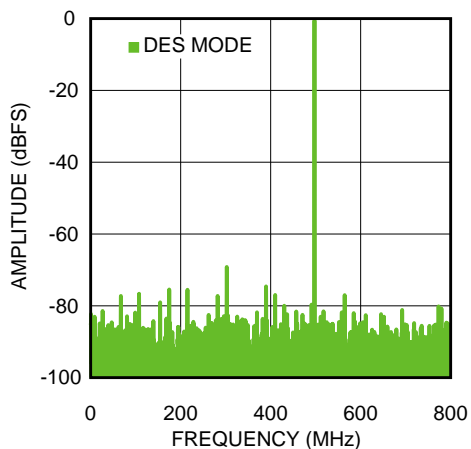

Figure 5-45.

SPECTRAL RESPONSE AT FIN = 498 MHz (ADC12D500RF)

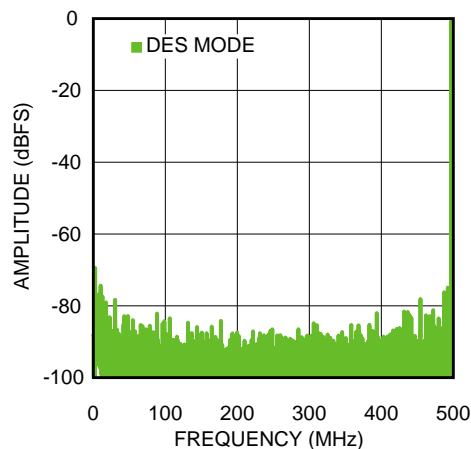

Figure 5-46.

CROSSTALK vs. SOURCE FREQUENCY (ADC12D800RF)

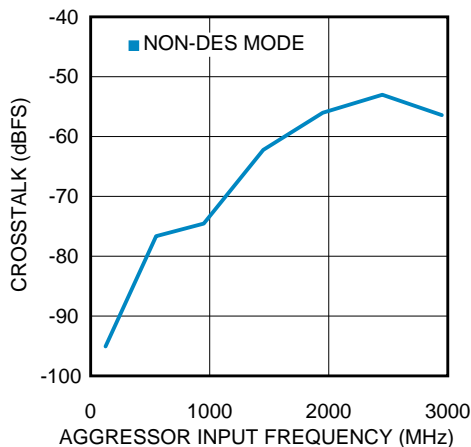

Figure 5-47.

CROSSTALK vs. SOURCE FREQUENCY (ADC12D500RF)

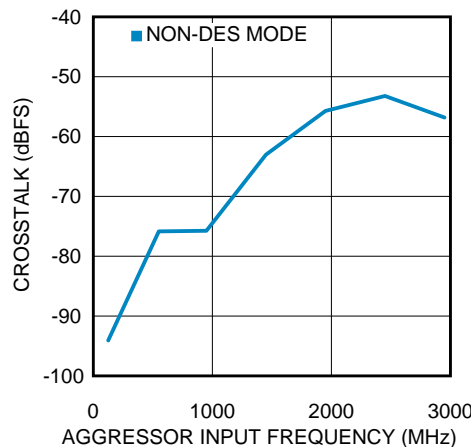

Figure 5-48.

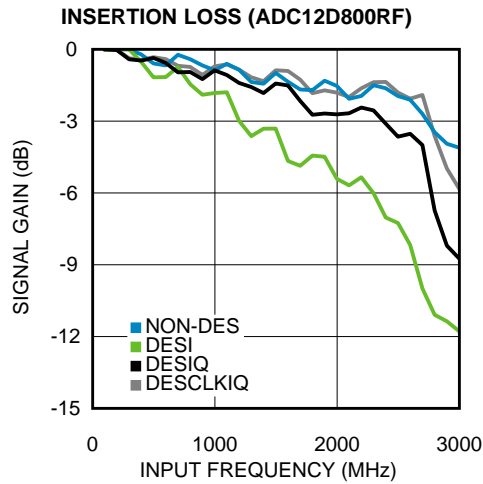

Figure 5-49.

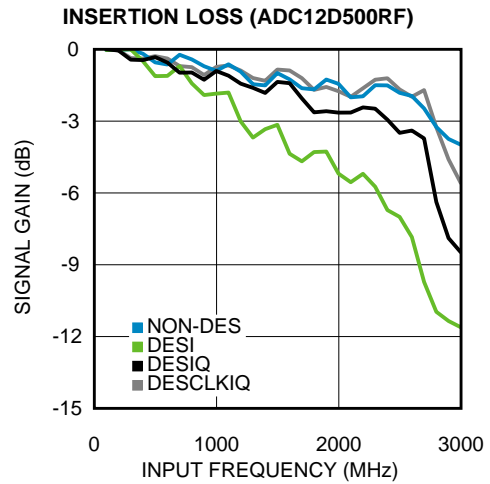

Figure 5-50.

POWER CONSUMPTION vs. CLOCK FREQUENCY (ADC12D800RF)

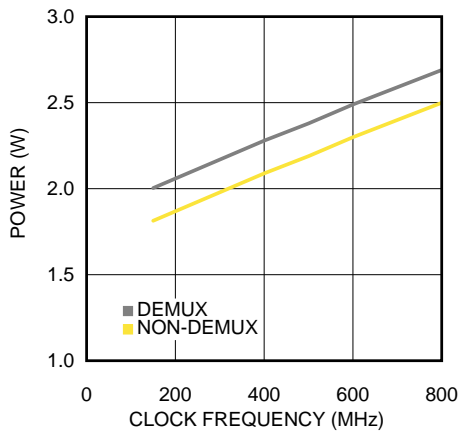

Figure 5-51.

POWER CONSUMPTION vs. CLOCK FREQUENCY (ADC12D500RF)

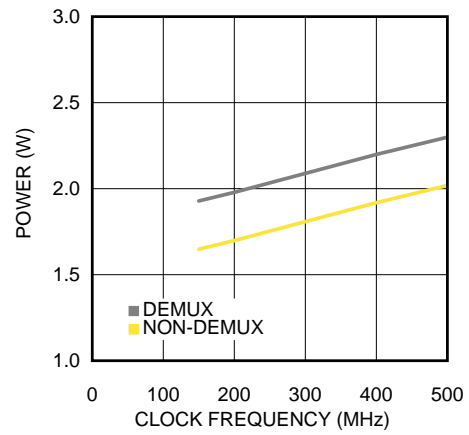

Figure 5-52.

NPR vs. RMS NOISE LOADING LEVEL (ADC12D800RF)

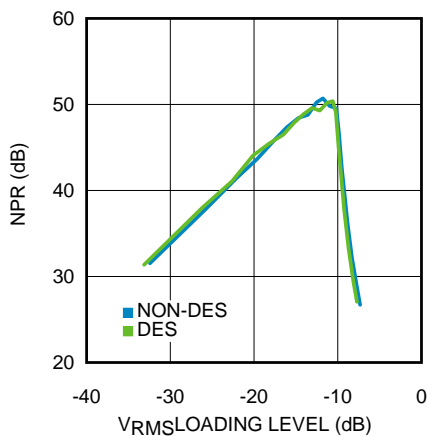

Figure 5-53.

NPR vs. RMS NOISE LOADING LEVEL (ADC12D500RF)

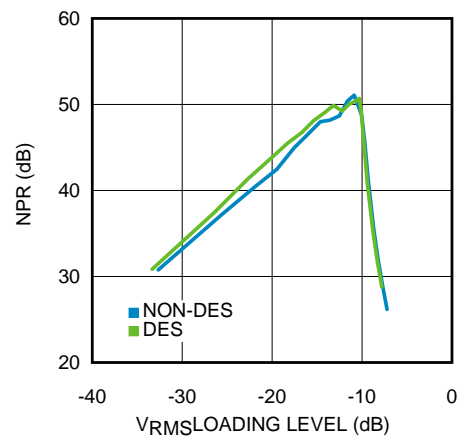

Figure 5-54.

NPR SPECTRAL RESPONSE (ADC12D800RF)

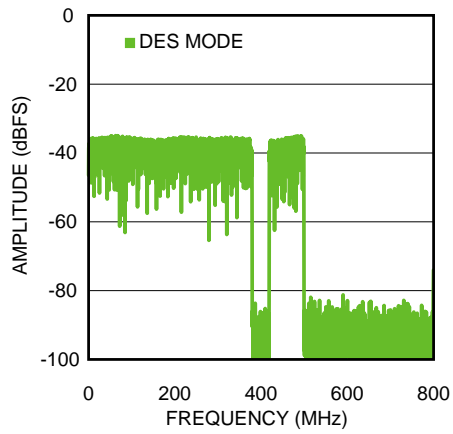

Figure 5-55.

NPR SPECTRAL RESPONSE (ADC12D500RF)

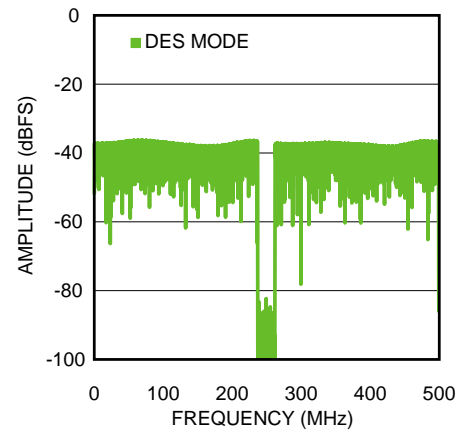

Figure 5-56.

6 Functional Description

The ADC12D800/500RF is a versatile A/D converter with an innovative architecture which permits very high speed operation. The controls available ease the application of the device to circuit solutions. Optimum performance requires adherence to the provisions discussed here and in the [Applications Information](#) Section. This section covers an overview, a description of control modes (Extended Control Mode and Non-Extended Control Mode), and features.

6.1 Overview

The ADC12D800/500RF uses a calibrated folding and interpolating architecture that achieves a high Effective Number of Bits (ENOB). The use of folding amplifiers greatly reduces the number of comparators and power consumption. Interpolation reduces the number of front-end amplifiers required, minimizing the load on the input signal and further reducing power requirements. In addition to correcting other non-idealities, on-chip calibration reduces the INL bow often seen with folding architectures. The result is an extremely fast, high performance, low power converter.

The analog input signal (which is within the converter's input voltage range) is digitized to twelve bits at speeds of 200/200 MSPS to 1.6/1.0 GSPS, typical. Differential input voltages below negative full-scale will cause the output word to consist of all zeroes. Differential input voltages above positive full-scale will cause the output word to consist of all ones. Either of these conditions at the I- or Q-input will cause the Out-of-Range I-channel or Q-channel output (ORI or ORQ), respectively, to output a logic-high signal.

In ECM, an expanded feature set is available via the Serial Interface. The ADC12D800/500RF builds upon previous architectures, introducing a new DES Mode timing adjust feature, AutoSync feature for multi-chip synchronization and increasing to 15-bit for gain and 12-bit plus sign for offset the independent programmable adjustment for each channel.

Each channel has a selectable output demultiplexer which feeds two LVDS buses. If the 1:2 Demux Mode is selected, the output data rate is reduced to half the input sample rate on each bus. When Non-Demux Mode is selected, the output data rate on each channel is at the same rate as the input sample clock and only one 12-bit bus per channel is active.

6.2 Control modes

The ADC12D800/500RF may be operated in one of two control modes: Non-extended Control Mode (Non-ECM) or Extended Control Mode (ECM). In the simpler Non-ECM (also sometimes referred to as Pin Control Mode), the user affects available configuration and control of the device through the control pins. The ECM provides additional configuration and control options through a serial interface and a set of 16 registers, most of which are available to the customer.

6.2.1 Non-Extended Control Mode

In Non-extended Control Mode (Non-ECM), the Serial Interface is not active and all available functions are controlled via various pin settings. Non-ECM is selected by setting the $\overline{\text{ECE}}$ Pin to logic-high. Note that, for the control pins, "logic-high" and "logic-low" refer to V_A and GND, respectively. Nine dedicated control pins provide a wide range of control for the ADC12D800/500RF and facilitate its operation. These control pins provide DES Mode selection, Demux Mode selection, DDR Phase selection, execute Calibration, Calibration Delay setting, Power Down I-channel, Power Down Q-channel, Test Pattern Mode selection, and Full-Scale Input Range selection. In addition to this, two dual-purpose control pins provide for AC/DC-coupled Mode selection and LVDS output common-mode voltage selection. See [Table 6-1](#) for a summary.

Table 6-1. Non-ECM Pin Summary

Pin Name	Logic-Low	Logic-High	Floating
Dedicated Control Pins			
DES	Non-DES Mode	DES Mode	Not valid
NDM	Demux Mode	Non-Demux Mode	Not valid
DDRPh	0° Mode / Falling Mode	90° Mode / Rising Mode	Not valid
CAL	See Calibration Pin (CAL)		Not valid
CalDly	Shorter delay	Longer delay	Not valid
PDI	I-channel active	Power Down I-channel	Power Down I-channel
PDQ	Q-channel active	Power Down Q-channel	Power Down Q-channel
TPM	Non-Test Pattern Mode	Test Pattern Mode	Not valid
FSR	Lower FS input Range	Higher FS input Range	Not valid
Dual-purpose Control Pins			
V _{CMO}	AC-coupled operation	Not allowed	DC-coupled operation
V _{BG}	Not allowed	Higher LVDS common-mode voltage	Lower LVDS common-mode voltage

6.2.1.1 Dual Edge Sampling Pin (DES)

The Dual Edge Sampling (DES) Pin selects whether the ADC12D800/500RF is in DES Mode (logic-high) or Non-DES Mode (logic-low). DES Mode means that a single analog input is sampled by both I- and Q-channels in a time-interleaved manner. One of the ADCs samples the input signal on the rising sampling clock edge (duty cycle corrected); the other ADC samples the input signal on the falling sampling clock edge (duty cycle corrected). In Non-ECM, only the I-input may be used for DES Mode, a.k.a. DESI Mode. In ECM, the Q-input may be selected via the DEQ Bit (Addr: 0h, Bit: 6), a.k.a. DESQ Mode. In ECM, both the I- and Q-inputs may be selected, a.k.a. DESIQ Mode.

To use this feature in ECM, use the DES bit in the Configuration Register (Addr: 0h; Bit: 7). See [DES/Non-DES Mode](#) for more information.

6.2.1.2 Non-Demultiplexed Mode Pin (NDM)

The Non-Demultiplexed Mode (NDM) Pin selects whether the ADC12D800/500RF is in Demux Mode (logic-low) or Non-Demux Mode (logic-high). In Non-Demux Mode, the data from the input is produced at the sampled rate at a single 12-bit output bus. In Demux Mode, the data from the input is produced at half the sampled rate at twice the number of output buses. For Non-DES Mode, each I- or Q-channel will produce its data on one or two buses for Non-Demux or Demux Mode, respectively. For DES Mode, the selected channel will produce its data on two or four buses for Non-Demux or Demux Mode, respectively. If Non-Demux Mode is selected, the default is DDR Mode. If Demux Mode is selected, the default is SDR Mode.

This feature is pin-controlled only and remains active during both Non-ECM and ECM. See [Demux/Non-demux Mode](#) for more information.

6.2.1.3 Dual Data Rate Phase Pin (DDRPh)

The Dual Data Rate Phase (DDRPh) Pin selects whether the ADC12D800/500RF is in 0° Mode (logic-low) or 90° Mode (logic-high) for DDR Mode. If the device is in SDR Mode, then the DDRPh Pin selects whether the ADC12D800/500RF is in Falling Mode (logic-low) or Rising Mode (logic-high). For DDR Mode, the Data may transition either with the DCLK transition (0° Mode) or halfway between DCLK transitions (90° Mode). The DDRPh Pin selects the mode for both the I-channel: DI- and DId-to-DCLKI phase relationship and for the Q-channel: DQ- and DQd-to-DCLKQ phase relationship.

To use this feature in ECM, use the DPS bit in the Configuration Register (Addr: 0h; Bit: 14). See [SDR / DDR Clock](#) for more information.

6.2.1.4 Calibration Pin (CAL)

The Calibration (CAL) Pin may be used to execute an on-command calibration or to disable the power-on calibration. The effect of calibration is to maximize the dynamic performance. To initiate an on-command calibration via the CAL pin, bring the CAL pin high for a minimum of $t_{\text{CAL_H}}$ input clock cycles after it has been low for a minimum of $t_{\text{CAL_L}}$ input clock cycles. Holding the CAL pin high upon power-on will prevent execution of the power-on calibration. In ECM, this pin remains active and is logically OR'd with the CAL bit.

To use this feature in ECM, use the CAL bit in the Configuration Register (Addr: 0h; Bit: 15). See [Calibration Feature](#) for more information.

6.2.1.5 Calibration Delay Pin (CalDly)

The Calibration Delay (CalDly) Pin selects whether a shorter or longer delay time is present, after the application of power, until the start of the power-on calibration. The actual delay time is specified as t_{CalDly} and may be found in [Converter Electrical Characteristics Calibration](#). This feature is pin-controlled only and remains active in ECM. It is recommended to select the desired delay time prior to power-on and not dynamically alter this selection.

See [Calibration Feature](#) for more information.

6.2.1.6 Power Down I-channel Pin (PDI)

The Power Down I-channel (PDI) Pin selects whether the I-channel is powered down (logic-high) or active (logic-low). The digital data output pins, DI and DI_d, (both positive and negative) are put into a high impedance state when the I-channel is powered down. Upon return to the active state, the pipeline will contain meaningless information and must be flushed. The supply currents (typicals and limits) are available for the I-channel powered down or active and may be found in [Converter Electrical Characteristics Power Supply Characteristics](#). The device should be recalibrated following a power-cycle of PDI (or PDQ).

This pin remains active in ECM. In ECM, either this pin or the PDI bit (Addr: 0h; Bit: 11) in the Control Register may be used to power-down the I-channel. See [Power Down](#) for more information.

6.2.1.7 Power Down Q-channel Pin (PDQ)

The Power Down Q-channel (PDQ) Pin selects whether the Q-channel is powered down (logic-high) or active (logic-low). This pin functions similarly to the PDI pin, except that it applies to the Q-channel. The PDI and PDQ pins function independently of each other to control whether each I- or Q-channel is powered down or active.

This pin remains active in ECM. In ECM, either this pin or the PDQ bit (Addr: 0h; Bit: 10) in the Control Register may be used to power-down the Q-channel. See [Power Down](#) for more information.

6.2.1.8 Test Pattern Mode Pin (TPM)

The Test Pattern Mode (TPM) Pin selects whether the output of the ADC12D800/500RF is a test pattern (logic-high) or the converted analog input (logic-low). The ADC12D800/500RF can provide a test pattern at the four output buses independently of the input signal to aid in system debug. In TPM, the ADC is disengaged and a test pattern generator is connected to the outputs, including ORI and ORQ. See [Test Pattern Mode](#) for more information.

6.2.1.9 Full-Scale Input Range Pin (FSR)

The Full-Scale Input Range (FSR) Pin selects whether the full-scale input range for both the I- and Q-channel is higher (logic-high) or lower (logic-low). The input full-scale range is specified as V_{IN_FSR} in [Converter Electrical Characteristics Analog Input/Output and Reference Characteristics](#). In Non-ECM, the full-scale input range for each I- and Q-channel may not be set independently, but it is possible to do so in ECM. The device must be calibrated following a change in FSR to obtain optimal performance.

To use this feature in ECM, use the Configuration Registers (Addr: **3h** and **Bh**). See [Input Control and Adjust](#) for more information.

6.2.1.10 AC/DC-Coupled Mode Pin (V_{CMO})

The V_{CMO} Pin serves a dual purpose. When functioning as an output, it provides the optimal common-mode voltage for the DC-coupled analog inputs. When functioning as an input, it selects whether the device is AC-coupled (logic-low) or DC-coupled (floating). This pin is always active, in both ECM and Non-ECM.

6.2.1.11 LVDS Output Common-mode Pin (V_{BG})

The V_{BG} Pin serves a dual purpose. When functioning as an output, it provides the bandgap reference. When functioning as an input, it selects whether the LVDS output common-mode voltage is higher (logic-high) or lower (floating). The LVDS output common-mode voltage is specified as V_{OS} and may be found in [Converter Electrical Characteristics Digital Control and Output Pin Characteristics](#). This pin is always active, in both ECM and Non-ECM.

6.2.2 Extended Control Mode

In Extended Control Mode (ECM), most functions are controlled via the Serial Interface. In addition to this, several of the control pins remain active. See [Table 6-4](#) for details. ECM is selected by setting the \overline{ECE} Pin to logic-low. If the \overline{ECE} Pin is set to logic-high (Non-ECM), then the registers are reset to their default values. So, a simple way to reset the registers is by toggling the \overline{ECE} pin. Four pins on the ADC12D800/500RF control the Serial Interface: \overline{SCS} , SCLK, SDI and SDO. This section covers the Serial Interface. The Register Definitions are located at the end of the datasheet so that they are easy to find, see [Register Definitions](#).

6.2.2.1 The Serial Interface

The ADC12D800/500RF offers a Serial Interface that allows access to the sixteen control registers within the device. The Serial Interface is a generic 4-wire (optionally 3-wire) synchronous interface that is compatible with SPI type interfaces that are used on many micro-controllers and DSP controllers. Each serial interface access cycle is exactly 24 bits long. A register-read or register-write can be accomplished in one cycle. The signals are defined in such a way that the user can opt to simply join SDI and SDO signals in his system to accomplish a single, bidirectional SDI/O signal. A summary of the pins for this interface may be found in [Table 6-2](#). See [Figure 4-9](#) for the timing diagram and [Converter Electrical Characteristics Serial Port Interface](#) for timing specification details. Control register contents are retained when the device is put into power-down mode. If this feature is unused, the SCLK, SDI, and \overline{SCS} pins may be left floating because they each have an internal pull-up.

Table 6-2. Serial Interface Pins

Pin	Name
C4	\overline{SCS} (Serial Chip Select bar)
C5	SCLK (Serial Clock)
B4	SDI (Serial Data In)
A3	SDO (Serial Data Out)

$\overline{\text{SCS}}$: Each assertion (logic-low) of this signal starts a new register access, i.e. the SDI command field must be ready on the following SCLK rising edge. The user is required to de-assert this signal after the 24th clock. If the $\overline{\text{SCS}}$ is de-asserted before the 24th clock, no data read/write will occur. For a read operation, if the $\overline{\text{SCS}}$ is asserted longer than 24 clocks, the SDO output will hold the D0 bit until $\overline{\text{SCS}}$ is de-asserted. For a write operation, if the $\overline{\text{SCS}}$ is asserted longer than 24 clocks, data write will occur normally through the SDI input upon the 24th clock. Setup and hold times, t_{SCS} and t_{HCS} , with respect to the SCLK must be observed. $\overline{\text{SCS}}$ must be toggled in between register access cycles.

SCLK: This signal is used to register the input data (SDI) on the rising edge; and to source the output data (SDO) on the falling edge. The user may disable the clock and hold it at logic-low. There is no minimum frequency requirement for SCLK; see f_{SCLK} in [Converter Electrical Characteristics Serial Port Interface](#) for more details.

SDI: Each register access requires a specific 24-bit pattern at this input, consisting of a command field and a data field. If the SDI and SDO wires are shared (3-wire mode), then during read operations, it is necessary to tri-state the master which is driving SDI while the data field is being output by the ADC on SDO. The master must be tri-stated before the falling edge of the 8th clock. If SDI and SDO are not shared (4-wire mode), then this is not necessary. Setup and hold times, t_{SH} and t_{SSU} , with respect to the SCLK must be observed.

SDO: This output is normally tri-stated and is driven only when $\overline{\text{SCS}}$ is asserted, the first 8 bits of command data have been received and it is a READ operation. The data is shifted out, MSB first, starting with the 8th clock's falling edge. At the end of the access, when $\overline{\text{SCS}}$ is de-asserted, this output is tri-stated once again. If an invalid address is accessed, the data sourced will consist of all zeroes. If it is a read operation, there will be a bus turnaround time, t_{BSU} , from when the last bit of the command field was read in until the first bit of the data field is written out.

Table 6-3 shows the Serial Interface bit definitions.

Table 6-3. Command and Data Field Definitions

Bit No.	Name	Comments
1	Read/Write (R/W)	1b indicates a read operation 0b indicates a write operation
2-3	Reserved	Bits must be set to 10b
4-7	A<3:0>	16 registers may be addressed. The order is MSB first
8	X	This is a "don't care" bit
9-24	D<15:0>	Data written to or read from addressed register

The serial data protocol is shown for a read and write operation in [Figure 6-1](#) and [Figure 6-2](#), respectively.

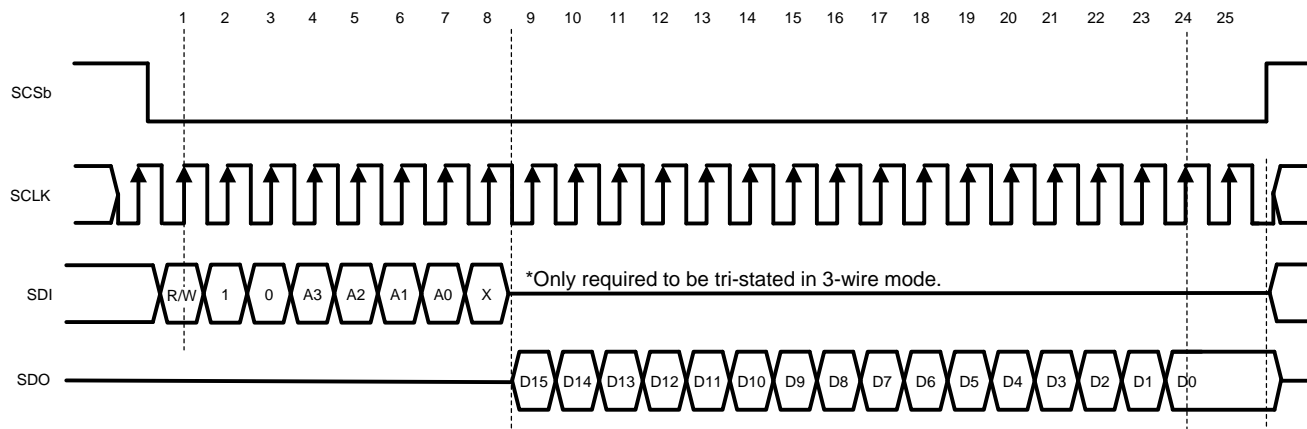

Figure 6-1. Serial Data Protocol - Read Operation

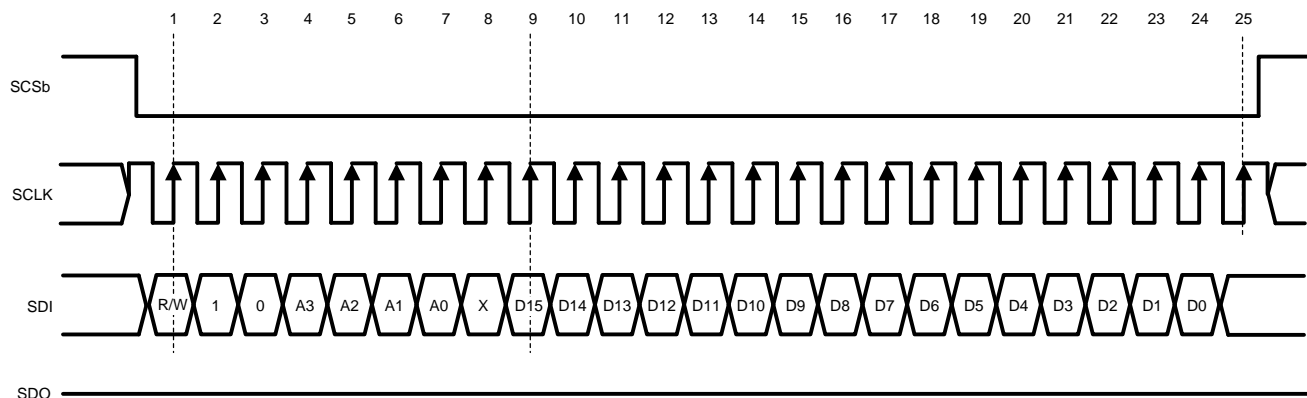

Figure 6-2. Serial Data Protocol - Write Operation

6.3 Features

The ADC12D800/500RF offers many features to make the device convenient to use in a wide variety of applications. [Table 6-4](#) is a summary of the features available, as well as details for the control mode chosen. "N/A" means "Not Applicable."

Table 6-4. Features and Modes

Feature	Non-ECM	Control Pin Active in ECM	ECM	Default ECM State
Input Control and Adjust				
AC/DC-coupled Mode Selection	Selected via V_{CMO} (Pin C2)	Yes	Not available	N/A
Input Full-scale Range Adjust	Selected via FSR (Pin Y3)	No	Selected via the Config Reg (Addr: 3h and Bh)	Mid FSR value
Input Offset Adjust Setting	Not available	N/A	Selected via the Config Reg (Addr: 2h and Ah)	Offset = 0 mV
DES / Non-DES Mode Selection	Selected via DES (Pin V5)	No	Selected via the DES Bit (Addr: 0h; Bit: 7)	Non-DES Mode
DES Mode Input Selection	Not available	N/A	Selected via the DEQ, DIQ Bits (Addr: 0h; Bits: 6:5)	N/A
DESCLIQ Mode⁽¹⁾	Not available	N/A	Selected via the DCK Bit (Addr: Eh; Bit: 6)	N/A
DES Timing Adjust⁽¹⁾	Not available	N/A	Selected via the DES Timing Adjust Reg (Addr: 7h)	Mid skew offset
Sampling Clock Phase Adjust	Not available	N/A	Selected via the Config Reg (Addr: Ch and Dh)	t_{AD} adjust disabled
Output Control and Adjust				
DDR Clock Phase Selection	Selected via DDRPh (Pin W4)	No	Selected via the DPS Bit (Addr: 0h; Bit: 14)	0° Mode
DDR / SDR DCLK Selection	Not available	N/A	Selected via the SDR Bit (Addr: 0h; Bit: 2)	DDR Mode
SDR Rising / Falling DCLK Selection⁽¹⁾	Not available	N/A	Selected via the DPS Bit (Addr: 0h; Bit: 14)	N/A
LVDS Differential Voltage Amplitude Selection	Higher amplitude only	N/A	Selected via the OVS Bit (Addr: 0h; Bit: 13)	Higher amplitude
LVDS Common-Mode Voltage Amplitude Selection⁽¹⁾	Selected via V_{BG} (Pin B1)	Yes	Not available	N/A
Output Formatting Selection⁽¹⁾	Offset Binary only	N/A	Selected via the 2SC Bit (Addr: 0h; Bit: 4)	Offset Binary
Test Pattern Mode at Output	Selected via TPM (Pin A4)	No	Selected via the TPM Bit (Addr: 0h; Bit: 12)	TPM disabled
Demux/Non-Demux Mode Selection	Selected via NDM (Pin A5)	Yes	Not available	N/A
AutoSync⁽¹⁾	Not available	N/A	Selected via the Config Reg (Addr: Eh)	Master Mode, RCOut1/2 disabled
DCLK Reset⁽¹⁾	Not available	N/A	Selected via the Config Reg (Addr: Eh; Bit: 0)	DCLK Reset disabled
Time Stamp⁽¹⁾	Not available	N/A	Selected via the TSE Bit (Addr: 0h; Bit: 3)	Time Stamp disabled
Calibration				
On-command Calibration	Selected via CAL (Pin D6)	Yes	Selected via the CAL Bit (Addr: 0h; Bit: 15)	N/A (CAL = 0)
Power-on Calibration Delay Selection	Selected via CalDly (Pin V4)	Yes	Not available	N/A
Calibration Adjust⁽¹⁾	Not available	N/A	Selected via the Config Reg (Addr: 4h)	t_{CAL}
Read/Write Calibration Settings⁽¹⁾	Not available	N/A	Selected via the SSC Bit (Addr: 4h; Bit: 7)	R/W calibration values disabled
Power-Down				
Power down I-channel	Selected via PDI (Pin U3)	Yes	Selected via the PDI Bit (Addr: 0h; Bit: 11)	I-channel operational

(1) This feature functionality is not tested in production test; performance is tested in the specified/default mode only.

Table 6-4. Features and Modes (continued)

Feature	Non-ECM	Control Pin Active in ECM	ECM	Default ECM State
Power down Q-channel	Selected via PDQ (Pin V3)	Yes	Selected via the PDQ Bit (Addr: 0h; Bit: 10)	Q-channel operational

6.3.1 Input Control and Adjust

There are several features and configurations for the input of the ADC12D800/500RF so that it may be used in many different applications. This section covers AC/DC-coupled Mode, input full-scale range adjust, input offset adjust, DES/Non-DES Mode, and sampling clock phase adjust.

6.3.1.1 AC/DC-coupled Mode

The analog inputs may be AC or DC-coupled. See [AC/DC-Coupled Mode Pin \(VCMO\)](#) for information on how to select the desired mode and [DC-coupled Input Signals](#) and [AC-coupled Input Signals](#) for applications information.

6.3.1.2 Input Full-Scale Range Adjust

The input full-scale range for the ADC12D800/500RF may be adjusted via Non-ECM or ECM. In Non-ECM, a control pin selects a higher or lower value; see [Full-Scale Input Range Pin \(FSR\)](#). In ECM, the input full-scale range may be adjusted with 15-bits of precision. See V_{IN_FSR} in [Converter Electrical Characteristics Analog Input/Output and Reference Characteristics](#) for electrical specification details. Note that the higher and lower full-scale input range settings in Non-ECM correspond to the mid and min full-scale input range settings in ECM. It is necessary to execute an on-command calibration following a change of the input full-scale range. See [Register Definitions](#) for information about the registers.

6.3.1.3 Input Offset Adjust

The input offset adjust for the ADC12D800/500RF may be adjusted with 12-bits of precision plus sign via ECM. See [Register Definitions](#) for information about the registers.

6.3.1.4 DES/Non-DES Mode

The ADC12D800/500RF can operate in Dual-Edge Sampling (DES) or Non-DES Mode. The DES Mode allows for a single analog input to be sampled by both I- and Q-channels. One channel samples the input on the rising edge of the sampling clock and the other samples the same input signal on the falling edge of the sampling clock. A single input is thus sampled twice per clock cycle, resulting in an overall sample rate of twice the sampling clock frequency, e.g. 1.6/1.0 GSPS with a 800/500 MHz sampling clock. Since DES Mode uses both I- and Q-channels to process the input signal, both channels must be powered up for the DES Mode to function properly.

In Non-ECM, only the I-input may be used for the DES Mode input. See [Dual Edge Sampling Pin \(DES\)](#) for information on how to select the DES Mode. In ECM, either the I- or Q-input may be selected by first using the DES bit (Addr: 0h, Bit 7) to select the DES Mode. The DEQ Bit (Addr: 0h, Bit: 6) is used to select the Q-input, but the I-input is used by default. Also, both I- and Q-inputs may be driven externally, i.e. DESIQ Mode, by using the DIQ bit (Addr: 0h, Bit 5). See [THE ANALOG INPUTS](#) for more information about how to drive the ADC in DES Mode.

In DESCLKIQ Mode, the I- and Q-channels sample their inputs 180° out-of-phase with respect to one another, similar to the other DES Modes. DESCLKIQ Mode is similar to the DESIQ Mode, except that the I- and Q-channels remain electrically separate internal to the ADC12D800/500RF. For this reason, both I- and Q-inputs must be externally driven for the DESCLKIQ Mode. The DCK Bit (Addr: Eh, Bit: 6) is used to select the 180° sampling clock mode.

The DESCLKIQ Mode results in the best bandwidth for the interleaved modes. In general, the bandwidth decreases from Non-DES Mode to DES Mode (specifically, DESI or DESQ) because both channels are sampling off the same input signal and non-ideal effects introduced by interleaving the two channels lower the bandwidth. Driving both I- and Q-channels externally (DESIQ Mode and DESCLKIQ Mode) results in better bandwidth because each channel is being driven, which reduces routing losses. The DESCLKIQ Mode has better bandwidth than the DESIQ Mode because the routing internal to the ADC12D800/500 is simpler, which results in less insertion loss.

In the DES Mode, the outputs must be carefully interleaved in order to reconstruct the sampled signal. If the device is programmed into the 1:4 Demux DES Mode, the data is effectively demultiplexed by 1:4. If the sampling clock is 800/500 MHz, the effective sampling rate is doubled to 1.6/1.0 GSPS and each of the 4 output buses has an output rate of 400/250 MSPS. All data is available in parallel. To properly reconstruct the sampled waveform, the four bytes of parallel data that are output with each DCLK must be correctly interleaved. The sampling order is as follows, from the earliest to the latest: DQd, DId, DQ, DI. See [Figure 4-5](#). If the device is programmed into the Non-Demux DES Mode, two bytes of parallel data are output with each edge of the DCLK in the following sampling order, from the earliest to the latest: DQ, DI. See [Figure 4-6](#).

6.3.1.5 DES Timing Adjust

The performance of the ADC12D800/500RF in DES Mode depends on how well the two channels are interleaved, i.e. that the clock samples either channel with precisely a 50% duty-cycle, each channel has the same offset (nominally code 2047/2048), and each channel has the same full-scale range. The ADC12D800/500RF includes an automatic clock phase background adjustment in DES Mode to automatically and continuously adjust the clock phase of the I- and Q-channels. In addition to this, the residual fixed timing skew offset may be further manually adjusted, and further reduce timing spurs for specific applications. See the DES Timing Adjust (Addr: 7h). As the DES Timing Adjust is programmed from 0d to 127d, the magnitude of the $F_s/2$ -Fin timing interleaving spur will decrease to a local minimum and then increase again. The default, nominal setting of 64d may or may not coincide with this local minimum. The user may manually skew the global timing to achieve the lowest possible timing interleaving spur.

6.3.1.6 Sampling Clock Phase Adjust

The sampling clock (CLK) phase may be delayed internally to the ADC up to 825 ps in ECM. This feature is intended to help the system designer remove small imbalances in clock distribution traces at the board level when multiple ADCs are used, or to simplify complex system functions such as beam steering for phase array antennas.

Additional delay in the clock path also creates additional jitter when using the sampling clock phase adjust. Because the sampling clock phase adjust delays all clocks, including the DCLKs and output data, the user is strongly advised to use the minimal amount of adjustment and verify the net benefit of this feature in his system before relying on it.

6.3.2 Output Control and Adjust

There are several features and configurations for the output of the ADC12D800/500RF so that it may be used in many different applications. This section covers DDR clock phase, LVDS output differential and common-mode voltage, output formatting, Demux/Non-demux Mode, Test Pattern Mode, and Time Stamp.

6.3.2.1 SDR / DDR Clock

The ADC12D800/500RF output data can be delivered in Double Data Rate (DDR) or Single Data Rate (SDR). For DDR, the DCLK frequency is half the data rate and data is sent to the outputs on both edges of DCLK; see [Figure 6-3](#). The DCLK-to-Data phase relationship may be either 0° or 90°. For 0° Mode, the Data transitions on each edge of the DCLK. Any offset from this timing is t_{OSK} ; see [Converter Electrical Characteristics AC Electrical Characteristics](#) for details. For 90° Mode, the DCLK transitions in the middle

of each Data cell. Setup and hold times for this transition, t_{SU} and t_H , may also be found in [Converter Electrical Characteristics AC Electrical Characteristics](#). The DCLK-to-Data phase relationship may be selected via the DDRPh Pin in Non-ECM (see [Dual Data Rate Phase Pin \(DDRPh\)](#)) or the DPS bit in the Configuration Register (Addr: 0h; Bit: 14) in ECM. Note that for DDR Mode, the 1:2 Demux Mode is not available.

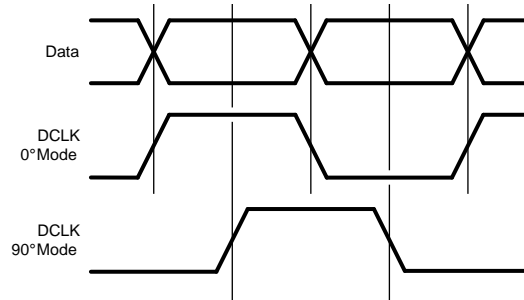

Figure 6-3. DDR DCLK-to-Data Phase Relationship

For SDR, the DCLK frequency is the same as the data rate and data is sent to the outputs on a single edge of DCLK; see [Figure 6-4](#). The Data may transition on either the rising or falling edge of DCLK. Any offset from this timing is t_{OSK} ; see [Converter Electrical Characteristics AC Electrical Characteristics](#) for details. The DCLK rising / falling edge may be selected via the SDR bit in the Configuration Register (Addr: 0h; Bit: 2) in ECM only.

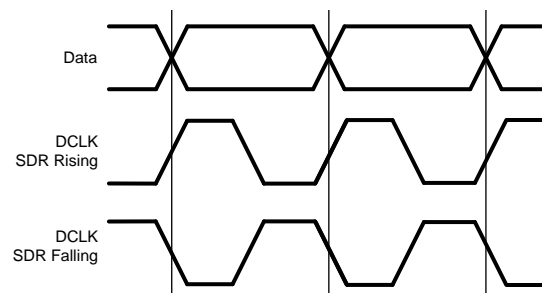

Figure 6-4. SDR DCLK-to-Data Phase Relationship

6.3.2.2 LVDS Output Differential Voltage

The ADC12D800/500RF is available with a selectable higher or lower LVDS output differential voltage. This parameter is V_{OD} and may be found in [Converter Electrical Characteristics Digital Control and Output Pin Characteristics](#). The desired voltage may be selected via the OVS Bit (Addr: 0h, Bit 13). For many applications, in which the LVDS outputs are very close to an FPGA on the same board, for example, the lower setting is sufficient for good performance; this will also reduce the possibility for EMI from the LVDS outputs to other signals on the board. See [Register Definitions](#) for more information.

6.3.2.3 LVDS Output Common-Mode Voltage

The ADC12D800/500RF is available with a selectable higher or lower LVDS output common-mode voltage. This parameter is V_{OS} and may be found in [Converter Electrical Characteristics Digital Control and Output Pin Characteristics](#). See [LVDS Output Common-mode Pin \(VBG\)](#) for information on how to select the desired voltage.

6.3.2.4 Output Formatting

The formatting at the digital data outputs may be either offset binary or two's complement. The default formatting is offset binary, but two's complement may be selected via the 2SC Bit (Addr: 0h, Bit 4); see [Register Definitions](#) for more information.

6.3.2.5 Demux/Non-demux Mode

The ADC12D800/500RF may be in one of two demultiplex modes: Demux Mode or Non-Demux Mode (also sometimes referred to as 1:1 Demux Mode). In Non-Demux Mode, the data from the input is simply output at the sampling rate on one 12-bit bus. In Demux Mode, the data from the input is output at half the sampling rate, on twice the number of buses. Demux/Non-Demux Mode may only be selected by the NDM pin. In Non-DES Mode, the output data from each channel may be demultiplexed by a factor of 1:2 (1:2 Demux Non-DES Mode) or not demultiplexed (Non-Demux Non-DES Mode). In DES Mode, the output data from both channels interleaved may be demultiplexed (1:4 Demux DES Mode) or not demultiplexed (Non-Demux DES Mode).

Note that for 1:2 Demux Mode, the Dual Data Rate (DDR) is not available. See [Table 6-5](#) for a selection of available modes.

Table 6-5. Supported Demux, Data Rate Modes

	Non-Demux Mode	1:2 Demux Mode
DDR	0° Mode / 90° Mode	Not Available
SDR	Rising / Falling Mode	Rising / Falling Mode

6.3.2.6 Test Pattern Mode

The ADC12D800/500RF can provide a test pattern at the four output buses independently of the input signal to aid in system debug. In Test Pattern Mode, the ADC is disengaged and a test pattern generator is connected to the outputs, including ORI and ORQ. The test pattern output is the same in DES Mode or Non-DES Mode. Each port is given a unique 12-bit word, alternating between 1's and 0's. When the part is programmed into the Demux Mode, the test pattern's order is described in [Table 6-6](#). If the I- or Q-channel is powered down, the test pattern will not be output for that channel.

Table 6-6. Test Pattern by Output Port in Demux Mode

Time	Qd	Id	Q	I	ORQ	ORI	Comments
T0	FF7h	FEFh	008h	010h	1b	1b	Pattern Sequence n
T1	FF7h	FEFh	008h	010h	1b	1b	
T2	008h	010h	FF7h	FEFh	1b	1b	
T3	008h	010h	FF7h	FEFh	1b	1b	
T4	008h	010h	008h	010h	0b	0b	Pattern Sequence n+1
T5	FF7h	FEFh	008h	010h	1b	1b	
T6	FF7h	FEFh	008h	010h	1b	1b	
T7	008h	010h	FF7h	FEFh	1b	1b	
T8	008h	010h	FF7h	FEFh	1b	1b	Pattern Sequence n+2
T9	008h	010h	008h	010h	0b	0b	
T10	FF7h	FEFh	008h	010h	1b	1b	
T11	FF7h	FEFh	008h	010h	1b	1b	
T12	008h	010h	FF7h	FEFh	1b	1b	
T13	

When the part is programmed into the Non-Demux Mode, the test pattern's order is described in [Table 6-7](#).

Table 6-7. Test Pattern by Output Port in Non-Demux Mode

Time	Q	I	ORQ	ORI	Comments
T0	008h	010h	0b	0b	Pattern Sequence n
T1	FF7h	FEFh	1b	1b	
T2	008h	010h	0b	0b	
T3	FF7h	FEFh	1b	1b	
T4	008h	010h	0b	0b	
T5	008h	010h	0b	0b	Pattern Sequence n+1
T6	FF7h	FEFh	1b	1b	
T7	008h	010h	0b	0b	
T8	FF7h	FEFh	1b	1b	
T9	008h	010h	0b	0b	
T10	008h	010h	0b	0b	Pattern Sequence n+2
T11	FF7h	FEFh	1b	1b	
T12	008h	010h	0b	0b	
T13	FF7h	FEFh	1b	1b	
T14	

6.3.2.7 Time Stamp

The Time Stamp feature enables the user to capture the timing of an external trigger event, relative to the sampled signal. When enabled via the TSE Bit (Addr: 0h; Bit: 3), the LSB of the digital outputs (DQd, DQ, DI, DI) captures the trigger information. In effect, the 12-bit converter becomes an 11-bit converter and the LSB acts as a 1-bit converter with the same latency as the 11-bit converter. The trigger should be applied to the DCLK_RST input. It may be asynchronous to the ADC sampling clock.

6.3.3 Calibration Feature

The ADC12D800/500RF calibration must be run to achieve specified performance. The calibration procedure is exactly the same regardless of how it was initiated or when it is run. Calibration trims the analog input differential termination resistors, the CLK input resistor, and sets internal bias currents which affect the linearity of the converter. This minimizes full-scale error, offset error, DNL and INL, which results in the maximum dynamic performance, as measured by: SNR, THD, SINAD (SNDR) and ENOB.

6.3.3.1 Calibration Control Pins and Bits

[Table 6-8](#) is a summary of the pins and bits used for calibration. See [Ball Descriptions and Equivalent Circuits](#) for complete pin information and [Figure 4-8](#) for the timing diagram.

Table 6-8. Calibration Pins

Pin (Bit)	Name	Function
D6 (Addr: 0h; Bit 15)	CAL (Calibration)	Initiate calibration
V4 (Addr: 4h)	CalDly (Calibration Delay) Calibration Adjust	Select power-on calibration delay Adjust calibration sequence
B5	CalRun (Calibration Running)	Indicates while calibration is running
C1/D2	Rtrim+/- (Input termination trim resistor)	External resistor used to calibrate analog and CLK inputs
C3/D3	Rext+/- (External Reference resistor)	External resistor used to calibrate internal linearity

6.3.3.2 How to Execute a Calibration

Calibration may be initiated by holding the CAL pin low for at least t_{CAL_L} clock cycles, and then holding it high for at least another t_{CAL_H} clock cycles, as defined in [Converter Electrical Characteristics Calibration](#). The minimum t_{CAL_L} and t_{CAL_H} input clock cycle sequences are required to ensure that random noise does not cause a calibration to begin when it is not desired. The time taken by the calibration procedure is specified as t_{CAL} . The CAL Pin is active in both ECM and Non-ECM. However, in ECM, the CAL Pin is logically OR'd with the CAL Bit, so both the pin and bit are required to be set low before executing another calibration via either pin or bit.

6.3.3.3 Power-on Calibration

For standard operation, power-on calibration begins after a time delay following the application of power, as determined by the setting of the CalDly Pin and measured by t_{CalDly} (see [Converter Electrical Characteristics Calibration](#)). This delay allows the power supply to come up and stabilize before the power-on calibration takes place. The best setting (short or long) of the CalDly Pin depends upon the settling time of the power supply.

It is strongly recommended to set CalDly Pin (to either logic-high or logic-low) before powering the device on since this pin affects the power-on calibration timing. This may be accomplished by setting CalDly via an external 1k Ω resistor connected to GND or V_A . If the CalDly Pin is toggled while the device is powered-on, it can execute a calibration even though the CAL Pin/Bit remains logic-low.

The power-on calibration will not be performed if the CAL pin is logic-high at power-on. In this case, the calibration cycle will not begin until the on-command calibration conditions are met. The ADC12D800/500RF will function with the CAL pin held high at power up, but no calibration will be done and performance will be impaired.

If it is necessary to toggle the CalDly Pin before the system power up sequence, then the CAL Pin/Bit must be set to logic-high during the toggling and afterwards for 10^9 Sampling Clock cycles. This will prevent the power-on calibration, so an on-command calibration must be executed or the performance will be impaired.

6.3.3.4 On-command Calibration

In addition to the power-on calibration, it is recommended to execute an on-command calibration whenever the settings or conditions to the device are altered significantly, in order to obtain optimal parametric performance. Some examples include: changing the FSR via either ECM or Non-ECM, power-cycling either channel, and switching into or out of DES Mode. For best performance, it is also recommended that an on-command calibration be run 20 seconds or more after application of power and whenever the operating temperature changes significantly, relative to the specific system performance requirements.

Due to the nature of the calibration feature, it is recommended to avoid unnecessary activities on the device while the calibration is taking place. For example, do not read or write to the Serial Interface or use the DCLK Reset feature while calibrating the ADC. Doing so will impair the performance of the device until it is re-calibrated correctly. Also, it is recommended to not apply a strong narrow-band signal to the analog inputs during calibration because this may impair the accuracy of the calibration; broad spectrum noise is acceptable.

6.3.3.5 Calibration Adjust

The sequence of the calibration event itself may be adjusted. This feature can be used if a shorter calibration time than the default is required; see t_{CAL} in [Converter Electrical Characteristics Calibration](#). However, the performance of the device, when using this feature is not ensured.

The calibration sequence may be adjusted via CSS (Addr: 4h, Bit 14). The default setting of CSS = 1b executes both R_{IN} and R_{IN_CLK} Calibration (using Rtrim) and internal linearity Calibration (using Rext). Executing a calibration with CSS = 0b executes only the internal linearity Calibration. The first time that Calibration is executed, it must be with CSS = 1b to trim R_{IN} and R_{IN_CLK} . However, once the device is at its operating temperature and R_{IN} has been trimmed at least one time, it will not drift significantly. To save time in subsequent calibrations, trimming R_{IN} and R_{IN_CLK} may be skipped, i.e. by setting CSS = 0b.

6.3.3.6 Read/Write Calibration Settings

When the ADC performs a calibration, the calibration constants are stored in an array which is accessible via the Calibration Values register (Addr: 5h). To save the time which it takes to execute a calibration, t_{CAL} , or to allow re-use of a previous calibration result, these values can be read from and written to the register at a later time. For example, if an application requires the same input impedance, R_{IN} , this feature can be used to load a previously determined set of values. For the calibration values to be valid, the ADC must be operating under the same conditions, including temperature, at which the calibration values were originally determined by the ADC.

To read calibration values from the SPI, do the following:

1. Set ADC to desired operating conditions.
2. Set SSC (Addr: 4h, Bit 7) to 1.
3. Read exactly 240 times the Calibration Values register (Addr: 5h). The register values are R0, R1, R2... R239 where R0 is a dummy value. The contents of R<239:1> should be stored.
4. Set SSC (Addr: 4h, Bit 7) to 0.
5. Continue with normal operation.

To write calibration values to the SPI, do the following:

1. Set ADC to operating conditions at which Calibration Values were previously read.
2. Set SSC (Addr: 4h, Bit 7) to 1.
3. Write exactly 239 times the Calibration Values register (Addr: 5h). The registers should be written with stored register values R1, R2... R239.
4. Make two additional dummy writes of 0000h.
5. Set SSC (Addr: 4h, Bit 7) to 0.
6. Continue with normal operation.

6.3.3.7 Calibration and Power-Down

If PDI and PDQ are simultaneously asserted during a calibration cycle, the ADC12D800/500RF will immediately power down. The calibration cycle will continue when either or both channels are powered back up, but the calibration will be compromised due to the incomplete settling of bias currents directly after power up. Therefore, a new calibration should be executed upon powering the ADC12D800/500RF back up. In general, the ADC12D800/500RF should be recalibrated when either or both channels are powered back up, or after one channel is powered down. For best results, this should be done after the device has stabilized to its operating temperature.

6.3.3.8 Calibration and the Digital Outputs

During calibration, the digital outputs (including DI, DI_d, DQ, DQ_d and OR) are set logic-low, to reduce noise. The DCLK runs continuously during calibration. After the calibration is completed and the CalRun signal is logic-low, it takes an additional 60 Sampling Clock cycles before the output of the ADC12D800/500RF is valid converted data from the analog inputs. This is the time it takes for the pipeline to flush, as well as for other internal processes.

6.3.4 Power Down

On the ADC12D800/500RF, the I- and Q-channels may be powered down individually. This may be accomplished via the control pins, PDI and PDQ, or via ECM. In ECM, the PDI and PDQ pins are logically OR'd with the Control Register setting. See [Power Down I-channel Pin \(PDI\)](#) and [Power Down Q-channel Pin \(PDQ\)](#) for more information.

6.4 Applications Information

6.4.1 THE ANALOG INPUTS

The ADC12D800/500RF will continuously convert any signal which is present at the analog inputs, as long as a CLK signal is also provided to the device. This section covers important aspects related to the analog inputs including: acquiring the input, driving the ADC in DES Mode, the reference voltage and FSR, out-of-range indication, AC/DC-coupled signals, and single-ended input signals.

6.4.1.1 Acquiring the Input

The Aperture Delay, t_{AD} , is the amount of delay, measured from the sampling edge of the clock input, after which signal present at the input pin is sampled inside the device. Data is acquired at the rising edge of CLK+ in Non-DES Mode and both the falling and rising edges of CLK+ in DES Mode. In Non-DES Mode, the I- and Q-channels always sample data on the rising edge of CLK+. In DES Mode, i.e. DESI, DESQ, DESIQ, and DESCLKIQ, the I-channel samples data on the rising edge of CLK+ and the Q-channel samples data on the falling edge of CLK+. The digital equivalent of that data is available at the digital outputs a constant number of sampling clock cycles later for the DI, DQ, DI_d and DQ_d output buses, a.k.a. Latency, depending on the demultiplex mode which is selected. In addition to the Latency, there is a constant output delay, t_{OD} , before the data is available at the outputs. See t_{OD} in the Timing Diagrams. See t_{LAT} , t_{AD} , and t_{OD} in [Converter Electrical Characteristics AC Electrical Characteristics](#).

6.4.1.2 Driving the ADC in DES Mode

The ADC12D800/500RF can be configured as either a 2-channel, 800/500 GSPS device (Non-DES Mode) or a 1-channel 1.6/1.0 GSPS device (DES Mode). When the device is configured in DES Mode, there is a choice for with which input to drive the single-channel ADC. These are the 3 options:

DES – externally driving the I-channel input only. This is the default selection when the ADC is configured in DES Mode. It may also be referred to as “DESI” for added clarity.

DESQ – externally driving the Q-channel input only.

DESIQ, DESCLKIQ – externally driving both the I- and Q-channel inputs. VinI+ and VinQ+ should be driven with the exact same signal. VinI- and VinQ- should be driven with the exact same signal, which is the differential compliment to the one driving VinI+ and VinQ+.

The input impedance for each I- and Q-input is 100Ω differential (or 50Ω single-ended), so the trace to each VinI+, VinI-, VinQ+, and VinQ- should always be 50Ω single-ended. If a single I- or Q-input is being driven, then that input will present a 100Ω differential load. For example, if a 50Ω single-ended source is driving the ADC, then a 1:2 balun will transform the impedance to 100Ω differential. However, if the ADC is being driven in DESIQ Mode, then the 100Ω differential impedance from the I-input will appear in parallel with the Q-input for a composite load of 50Ω differential and a 1:1 balun would be appropriate. See Figure 6-5 for an example circuit driving the ADC in DESIQ Mode. A recommended part selection is using the Mini-Circuits TC1-1-13MA+ balun with Ccouple = 0.22μF.

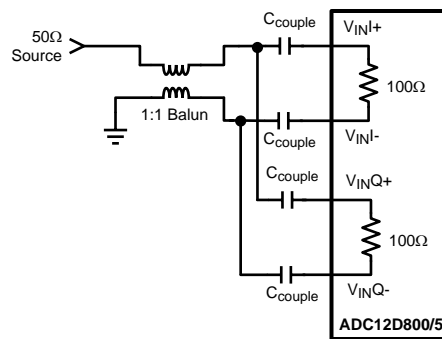

Figure 6-5. Driving DESIQ Mode

In the case that only one channel is used in Non-DES Mode or that the ADC is driven in DESI or DESQ Mode, the unused analog input should be terminated to reduce any noise coupling into the ADC. See Table 6-9 for details.

Table 6-9. Unused Analog Input Recommended Termination

Mode	Power Down	Coupling	Recommended Termination
Non-DES	Yes	AC/DC	Tie Unused+ and Unused- to Vbg
DES/Non-DES	No	DC	Tie Unused+ and Unused- to Vbg
DES/Non-DES	No	AC	Tie Unused+ to Unused-

6.4.1.3 FSR and the Reference Voltage

The full-scale analog differential input range (V_{IN_FSR}) of the ADC12D800/500RF is derived from an internal bandgap reference. In Non-ECM, this full-scale range has two settings controlled by the FSR Pin; see Full-Scale Input Range Pin (FSR). The FSR Pin operates on both I- and Q-channels. In ECM, the full-scale range may be independently set for each channel via Addr:3h and Bh with 15 bits of precision; see Register Definitions. The best SNR is obtained with a higher full-scale input range, but better distortion and SFDR are obtained with a lower full-scale input range. It is not possible to use an external analog reference voltage to modify the full-scale range, and this adjustment should only be done digitally, as described.

A buffered version of the internal bandgap reference voltage is made available at the V_{BG} Pin for the user. The V_{BG} pin can drive a load of up to 80 pF and source or sink up to 100 μA. It should be buffered if more current than this is required. This pin remains as a constant reference voltage regardless of what full-scale range is selected and may be used for a system reference. V_{BG} is a dual-purpose pin and it may also be used to select a higher LVDS output common-mode voltage; see LVDS Output Common-mode Pin (VBG).

6.4.1.4 Out-Of-Range Indication

Differential input signals are digitized to 12 bits, based on the full-scale range. Signal excursions beyond the full-scale range, i.e. greater than $+V_{IN_FSR}/2$ or less than $-V_{IN_FSR}/2$, will be clipped at the output. An input signal which is above the FSR will result in all 1's at the output and an input signal which is below the FSR will result in all 0's at the output. When the conversion result is clipped for the I-channel input, the Out-of-Range I-channel (ORI) output is activated such that ORI+ goes high and ORI- goes low while the signal is out of range. This output is active as long as accurate data on either or both of the buses would be outside the range of 000h to FFFh. The Q-channel has a separate ORQ which functions similarly.

6.4.1.5 Maximum Input Range

The recommended operating and absolute maximum input range may be found in [Operating Ratings](#) and [Absolute Maximum Ratings](#), respectively. Under the stated allowed operating conditions, each Vin+ and Vin- input pin may be operated in the range from 0V to 2.15V if the input is a continuous 100% duty cycle signal and from 0V to 2.5V if the input is a 10% duty cycle signal. The absolute maximum input range for Vin+ and Vin- is from -0.15V to 2.5V. These limits apply only for input signals for which the input common mode voltage is properly maintained.

6.4.1.6 AC-coupled Input Signals

The ADC12D800/500RF analog inputs require a precise common-mode voltage. This voltage is generated on-chip when AC-coupling Mode is selected. See [AC/DC-Coupled Mode Pin \(VCMO\)](#) for more information about how to select AC-coupled Mode.

In AC-coupled Mode, the analog inputs must of course be AC-coupled. For an ADC12D800/500RF used in a typical application, this may be accomplished by on-board capacitors, as shown in [Figure 6-6](#). For the ADC12D800RFRB, the SMA inputs on the Reference Board are directly connected to the analog inputs on the ADC12D800RF, so this may be accomplished by DC blocks (included with the hardware kit).

When the AC-coupled Mode is selected, an analog input channel that is not used (e.g. in DES Mode) should be connected to AC ground, e.g. through capacitors to ground. Do not connect an unused analog input directly to ground.

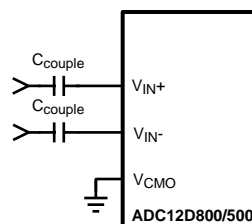

Figure 6-6. AC-coupled Differential Input

The analog inputs for the ADC12D800/500RF are internally buffered, which simplifies the task of driving these inputs and the RC pole which is generally used at sampling ADC inputs is not required. If the user desires to place an amplifier circuit before the ADC, care should be taken to choose an amplifier with adequate noise and distortion performance, and adequate gain at the frequencies used for the application.

6.4.1.7 DC-coupled Input Signals

In DC-coupled Mode, the ADC12D800/500RF differential inputs must have the correct common-mode voltage. This voltage is provided by the device itself at the V_{CMO} output pin. It is recommended to use this voltage because the V_{CMO} output potential will change with temperature and the common-mode voltage of the driving device should track this change. Full-scale distortion performance falls off as the input common mode voltage deviates from V_{CMO} . Therefore, it is recommended to keep the input common-mode voltage within 100 mV of V_{CMO} (typical), although this range may be extended to ± 150 mV (maximum). See V_{CMI} in [Converter Electrical Characteristics Analog Input/Output and Reference Characteristics](#) and ENOB vs. V_{CMI} in [Typical Performance Plots](#). Performance in AC- and DC-coupled Mode are similar, provided that the input common mode voltage at both analog inputs remains within 100 mV of V_{CMO} .

6.4.1.8 Single-Ended Input Signals

The analog inputs of the ADC12D800/500RF are not designed to accept single-ended signals. The best way to handle single-ended signals is to first convert them to differential signals before presenting them to the ADC. The easiest way to accomplish single-ended to differential signal conversion is with an appropriate balun-transformer, as shown in [Figure 6-7](#).

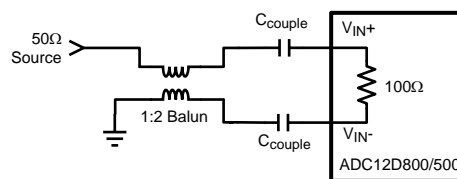

Figure 6-7. Single-Ended to Differential Conversion Using a Balun

When selecting a balun, it is important to understand the input architecture of the ADC. The impedance of the analog source should be matched to the ADC12D800/500RF's on-chip 100Ω differential input termination resistor. The range of this termination resistor is specified as R_{IN} in [Converter Electrical Characteristics Analog Input/Output and Reference Characteristics](#).

6.4.2 THE CLOCK INPUTS

The ADC12D800/500RF has a differential clock input, CLK+ and CLK-, which must be driven with an AC-coupled, differential clock signal. This provides the level shifting necessary to allow for the clock to be driven with LVDS, PECL, LVPECL, or CML levels. The clock inputs are internally terminated to 100Ω differential and self-biased. This section covers coupling, frequency range, level, duty-cycle, jitter, and layout considerations.

6.4.2.1 CLK Coupling

The clock inputs of the ADC12D800/500RF must be capacitively coupled to the clock pins as indicated in [Figure 6-8](#).

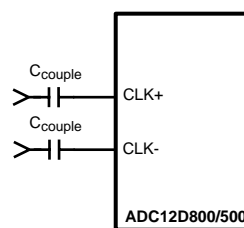

Figure 6-8. Differential Input Clock Connection

The choice of capacitor value will depend on the clock frequency, capacitor component characteristics and other system economic factors. For example, on the ADC12D800RFRB, the capacitors have the value $C_{\text{couple}} = 4.7 \text{ nF}$ which yields a highpass cutoff frequency, $f_c = 677.2 \text{ kHz}$.

6.4.2.2 CLK Frequency

Although the ADC12D800/500RF is tested and its performance is ensured with a differential 1.0/1.6 GHz sampling clock, it will typically function well over the input clock frequency range; see $f_{\text{CLK}}(\text{min})$ and $f_{\text{CLK}}(\text{max})$ in [Converter Electrical Characteristics AC Electrical Characteristics](#). Operation up to $f_{\text{CLK}}(\text{max})$ is possible if the maximum ambient temperatures indicated are not exceeded. Operating at sample rates above $f_{\text{CLK}}(\text{max})$ for the maximum ambient temperature may result in reduced device reliability and product lifetime. This is due to the fact that higher sample rates results in higher power consumption and die temperatures.

6.4.2.3 CLK Level

The input clock amplitude is specified as $V_{\text{IN_CLK}}$ in [Converter Electrical Characteristics Sampling Clock Characteristics](#). Input clock amplitudes above the max $V_{\text{IN_CLK}}$ may result in increased input offset voltage. This would cause the converter to produce an output code other than the expected 2047/2048 when both input pins are at the same potential. Insufficient input clock levels will result in poor dynamic performance. Both of these results may be avoided by keeping the clock input amplitude within the specified limits of $V_{\text{IN_CLK}}$.

6.4.2.4 CLK Duty Cycle

The duty cycle of the input clock signal can affect the performance of any A/D converter. The ADC12D800/500RF features a duty cycle clock correction circuit which can maintain performance over the 20%-to-80% specified clock duty-cycle range. This feature is enabled by default and provides improved ADC clocking, especially in the Dual-Edge Sampling (DES) Mode.

6.4.2.5 CLK Jitter

High speed, high performance ADCs such as the ADC12D800/500RF require a very stable input clock signal with minimum phase noise or jitter. ADC jitter requirements are defined by the ADC resolution (number of bits), maximum ADC input frequency and the input signal amplitude relative to the ADC input full scale range. The maximum jitter (the sum of the jitter from all sources) allowed to prevent a jitter-induced reduction in SNR is found to be

$$t_{\text{J(MAX)}} = (V_{\text{IN(P-P)}} / V_{\text{FSR}}) \times (1 / (2^{(N+1)} \times \pi \times f_{\text{IN}})) \quad (1)$$

where $t_{\text{J(MAX)}}$ is the rms total of all jitter sources in seconds, $V_{\text{IN(P-P)}}$ is the peak-to-peak analog input signal, V_{FSR} is the full-scale range of the ADC, "N" is the ADC resolution in bits and f_{IN} is the maximum input frequency, in Hertz, at the ADC analog input.

$t_{\text{J(MAX)}}$ is the square root of the sum of the squares (RSS) of the jitter from all sources, including: the ADC input clock, system, input signals and the ADC itself. Since the effective jitter added by the ADC is beyond user control, it is recommended to keep the sum of all other externally added jitter to a minimum.

6.4.2.6 CLK Layout

The ADC12D800/500RF clock input is internally terminated with a trimmed 100Ω resistor. The differential input clock line pair should have a characteristic impedance of 100Ω and (when using a balun), be terminated at the clock source in that (100Ω) characteristic impedance.

It is good practice to keep the ADC input clock line as short as possible, tightly coupled, keep it well away from any other signals, and treat it as a transmission line. Otherwise, other signals can introduce jitter into the input clock signal. Also, the clock signal can introduce noise into the analog path if it is not properly isolated.

6.4.3 THE LVDS OUTPUTS

The Data, ORI, ORQ, DCLKI and DCLKQ outputs are LVDS. The electrical specifications of the LVDS outputs are compatible with typical LVDS receivers available on ASIC and FPGA chips; but they are not IEEE or ANSI communications standards compliant due to the low +1.9V supply used on this chip. These outputs should be terminated with a 100Ω differential resistor placed as closely to the receiver as possible. If the 100Ω differential resistance is built in to the receiver, then an externally placed resistor is not necessary. This section covers common-mode and differential voltage, and data rate.

6.4.3.1 Common-mode and Differential Voltage

The LVDS outputs have selectable common-mode and differential voltage, V_{OS} and V_{OD} ; see [Converter Electrical Characteristics Digital Control and Output Pin Characteristics](#). See [Output Control and Adjust](#) for more information.

Selecting the higher V_{OS} will also increase V_{OD} slightly. The differential voltage, V_{OD} , may be selected for the higher or lower value. For short LVDS lines and low noise systems, satisfactory performance may be realized with the lower V_{OD} . This will also result in lower power consumption. If the LVDS lines are long and/or the system in which the ADC12D800/500RF is used is noisy, it may be necessary to select the higher V_{OD} .

6.4.3.2 Output Data Rate

The data is produced at the output at the same rate it is sampled at the input. The minimum recommended input clock rate for this device is $f_{CLK(MIN)}$; see [Converter Electrical Characteristics AC Electrical Characteristics](#). However, it is possible to operate the device in 1:2 Demux Mode and capture data from just one 12-bit bus, e.g. just DI (or DI_d) although both DI and DI_d are fully operational. This will decimate the data by two and effectively halve the data rate.

6.4.3.3 Terminating Unused LVDS Output Pins

If the ADC is used in Non-Demux Mode, then only the DI and DQ data outputs will have valid data present on them. The DI_d and DQ_d data outputs may be left not connected; if unused, they are internally tri-stated.

Similarly, if the Q-channel is powered-down (i.e. PDQ is logic-high), the DQ data output pins, DCLKQ and ORQ may be left not connected.

6.4.4 SYNCHRONIZING MULTIPLE ADC12D800/500RFS IN A SYSTEM

The ADC12D800/500RF has two features to assist the user with synchronizing multiple ADCs in a system; AutoSync and DCLK Reset. The AutoSync feature is new and designates one ADC12D800/500RF as the Master ADC and other ADC12D800/500RFs in the system as Slave ADCs. The DCLK Reset feature performs the same function as the AutoSync feature, but is the first generation solution to synchronizing multiple ADCs in a system; it is disabled by default. For the application in which there are multiple Master and Slave ADC12D800/500RFs in a system, AutoSync may be used to synchronize the Slave ADC12D800/500RF(s) to each respective Master ADC12D800/500RF and the DCLK Reset may be used to synchronize the Master ADC12D800/500RFs to each other.

If the AutoSync or DCLK Reset feature is not used, see [Table 6-10](#) for recommendations about terminating unused pins.

Table 6-10. Unused AutoSync and DCLK Reset Pin Recommendation

Pin(s)	Unused termination
RCLK+/-	Do not connect.
RCOUT1+/-	Do not connect.
RCOUT2+/-	Do not connect.
DCLK_RST+	Connect to GND via 1kΩ resistor.
DCLK_RST-	Connect to V _A via 1kΩ resistor.

6.4.4.1 AutoSync Feature

AutoSync is a new feature which continuously synchronizes the outputs of multiple ADC12D800/500RFs in a system. It may be used to synchronize the DCLK and data outputs of one or more Slave ADC12D800/500RFs to one Master ADC12D800/500RF. Several advantages of this feature include: no special synchronization pulse required, any upset in synchronization is recovered upon the next DCLK cycle, and the Master/Slave ADC12D800/500RFs may be arranged as a binary tree so that any upset will quickly propagate out of the system.

An example system is shown below in Figure 6-9 which consists of one Master ADC and two Slave ADCs. For simplicity, only one DCLK is shown; in reality, there is DCLKI and DCLKQ, but they are always in phase with one another.

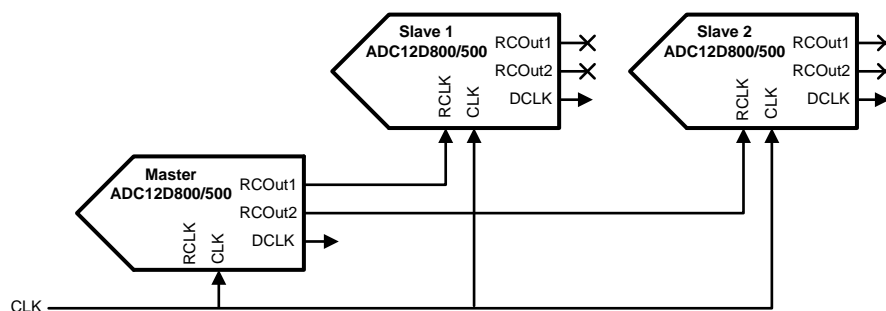

Figure 6-9. AutoSync Example

In order to synchronize the DCLK (and Data) outputs of multiple ADCs, the DCLKs must transition at the same time, as well as be in phase with one another. The DCLK at each ADC is generated from the CLK after some latency, plus t_{OD} minus t_{AD} . Therefore, in order for the DCLKs to transition at the same time, the CLK signal must reach each ADC at the same time. To tune out any differences in the CLK path to each ADC, the t_{AD} adjust feature may be used. However, using the t_{AD} adjust feature will also affect when the DCLK is produced at the output. If the device is in Demux Mode, then there are four possible phases which each DCLK may be generated on because the typical CLK = 1GHz and DCLK = 250 MHz for this case. The RCLK signal controls the phase of the DCLK, so that each Slave DCLK is on the same phase as the Master DCLK.

The AutoSync feature may only be used via the Control Registers. For more information, see [AN-2132](#).

6.4.4.2 DCLK Reset Feature

The DCLK reset feature is available via ECM, but it is disabled by default. DCLKI and DCLKQ are always synchronized, by design, and do not require a pulse from DCLK_RST to become synchronized.

The DCLK_RST signal must observe certain timing requirements, which are shown in Figure 4-7 of the Timing Diagrams. The DCLK_RST pulse must be of a minimum width and its deassertion edge must observe setup and hold times with respect to the CLK input rising edge. These timing specifications are listed as t_{PWR} , t_{SR} and t_{HR} and may be found in [Converter Electrical Characteristics AC Electrical Characteristics](#).

The DCLK_RST signal can be asserted asynchronously to the input clock. If DCLK_RST is asserted, the DCLK output is held in a designated state (logic-high) in Demux Mode; in Non-Demux Mode, the DCLK continues to function normally. Depending upon when the DCLK_RST signal is asserted, there may be a narrow pulse on the DCLK line during this reset event. When the DCLK_RST signal is de-asserted, there are $t_{\text{SYNC_DLY}}$ CLK cycles of systematic delay and the next CLK rising edge synchronizes the DCLK output with those of other ADC12D800/500RFs in the system. For 90° Mode (DDRPh = logic-high), the synchronizing edge occurs on the rising edge of CLK, 4 cycles after the first rising edge of CLK after DCLK_RST is released. For 0° Mode (DDRPh = logic-low), this is 5 cycles instead. The DCLK output is enabled again after a constant delay of t_{OD} .

For both Demux and Non-Demux Modes, there is some uncertainty about how DCLK comes out of the reset state for the first DCLK_RST pulse. For the second (and subsequent) DCLK_RST pulses, the DCLK will come out of the reset state in a known way. Therefore, if using the DCLK Reset feature, it is recommended to apply one "dummy" DCLK_RST pulse before using the second DCLK_RST pulse to synchronize the outputs. This recommendation applies each time the device or channel is powered-on.

When using DCLK_RST to synchronize multiple ADC12D800/500RFs, it is required that the Select Phase bits in the Control Register (Addr: Eh, Bits 3,4) be the same for each Master ADC12D800/500RF.

6.4.5 SUPPLY/GROUNDING, LAYOUT AND THERMAL RECOMMENDATIONS

6.4.5.1 Power Planes

All supply buses for the ADC should be sourced from a common linear voltage regulator. This ensures that all power buses to the ADC are turned on and off simultaneously. This single source will be split into individual sections of the power plane, with individual decoupling and connection to the different power supply buses of the ADC. Due to the low voltage but relatively high supply current requirement, the optimal solution may be to use a switching regulator to provide an intermediate low voltage, which is then regulated down to the final ADC supply voltage by a linear regulator. Please refer to the documentation provided for the [ADC12D800FRB](#) for additional details on specific regulators that are recommended for this configuration.

Power for the ADC should be provided through a broad plane which is located on one layer adjacent to the ground plane(s). Placing the power and ground planes on adjacent layers will provide low impedance decoupling of the ADC supplies, especially at higher frequencies. The output of a linear regulator should feed into the power plane through a low impedance multi-via connection. The power plane should be split into individual power peninsulas near the ADC. Each peninsula should feed a particular power bus on the ADC, with decoupling for that power bus connecting the peninsula to the ground plane near each power/ground pin pair. Using this technique can be difficult on many printed circuit CAD tools. To work around this, zero ohm resistors can be used to connect the power source net to the individual nets for the different ADC power buses. As a final step, the zero ohm resistors can be removed and the plane and peninsulas can be connected manually after all other error checking is completed.

6.4.5.2 Bypass Capacitors

The general recommendation is to have one 100nF capacitor for each power/ground pin pair. The capacitors should be surface mount multi-layer ceramic chip capacitors similar to Panasonic part number ECJ-0EB1A104K.

6.4.5.3 Ground Planes

Grounding should be done using continuous full ground planes to minimize the impedance for all ground return paths, and provide the shortest possible image/return path for all signal traces.

6.4.5.4 Power System Example

The ADC12D800RFRB uses continuous ground planes (except where clear areas are needed to provide appropriate impedance management for specific signals), see [Figure 6-10](#). Power is provided on one plane, with the 1.9V ADC supply being split into multiple zones or peninsulas for the specific power buses of the ADC. Decoupling capacitors are connected between these power bus peninsulas and the adjacent ground planes using vias. The capacitors are located as close to the individual power/ground pin pairs of the ADC as possible. In most cases, this means the capacitors are located on the opposite side of the PCB to the ADC.

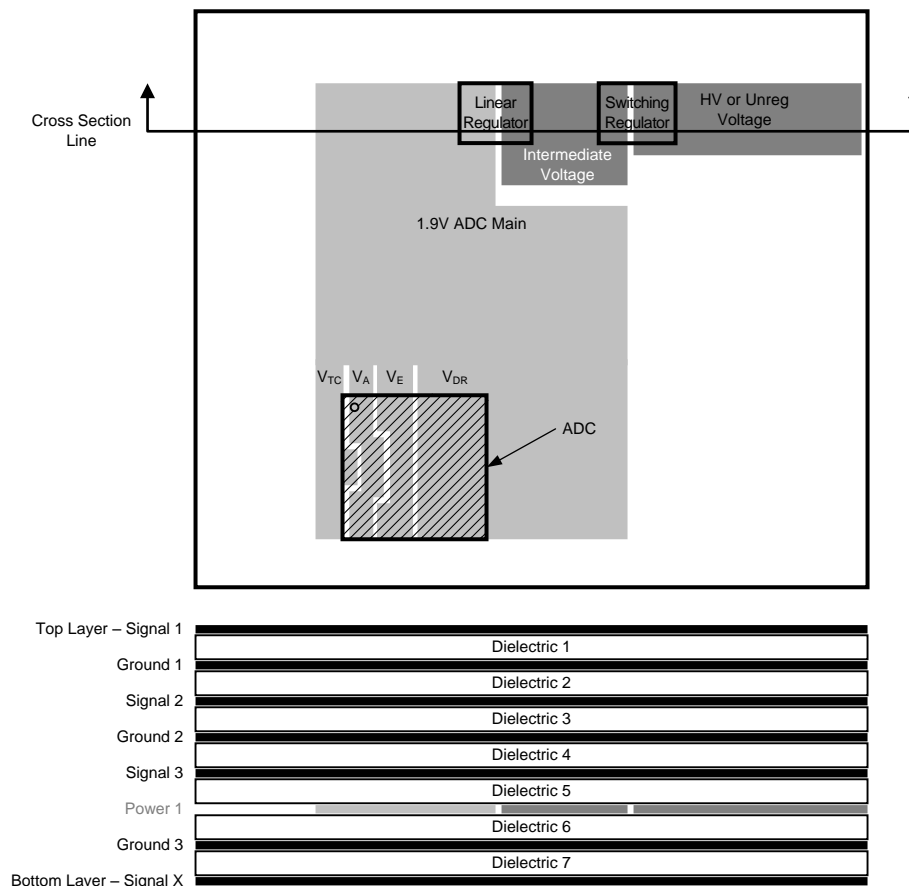

Figure 6-10. Power and Grounding Example

6.4.5.5 Thermal Management

The Heat Slug Ball Grid Array (HSBGA) package is a modified version of the industry standard plastic BGA (Ball Grid Array) package. Inside the package, a copper heat spreader cap is attached to the substrate top with exposed metal in the center top area of the package. This results in a 20% improvement (typical) in thermal performance over the standard plastic BGA package.

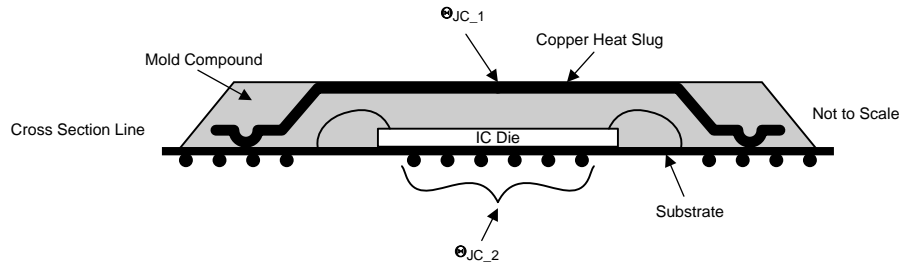

Figure 6-11. HSBGA Conceptual Drawing

The center balls are connected to the bottom of the die by vias in the package substrate, [Figure 6-11](#). This gives a low thermal resistance between the die and these balls. Connecting these balls to the PCB ground planes with a low thermal resistance path is the best way to dissipate the heat from the ADC. These pins should also be connected to the ground plane via a low impedance path for electrical purposes. The direct connection to the ground planes is an easy method to spread heat away from the ADC. Along with the ground plane, the parallel power planes will provide additional thermal dissipation.

The center ground balls should be soldered down to the recommended ball pads (See [AN-1126](#)). These balls will have wide traces which in turn have vias which connect to the internal ground planes, and a bottom ground pad/pour if possible. This ensures a good ground is provided for these balls, and that the optimal heat transfer will occur between these balls and the PCB ground planes.

In spite of these package enhancements, analysis using the standard JEDEC JESD51-7 four-layer PCB thermal model shows that ambient temperatures must be limited to 70/77°C to ensure a safe operating junction temperature for the ADC12D800/500RF. However, most applications using the ADC12D800/500RF will have a printed circuit board which is more complex than that used in JESD51-7. Typical circuit boards will have more layers than the JESD51-7 (eight or more), several of which will be used for ground and power planes. In those applications, the thermal resistance parameters of the ADC12D800/500RF and the circuit board can be used to determine the actual safe ambient operating temperature up to a maximum of 85°C.

Three key parameters are provided to allow for modeling and calculations. Because there are two main thermal paths between the ADC die and external environment, the thermal resistance for each of these paths is provided. θ_{JC1} represents the thermal resistance between the die and the exposed metal area on the top of the HSBGA package. θ_{JC2} represents the thermal resistance between the die and the center group of balls on the bottom of the HSBGA package. The final parameter is the allowed maximum junction temperature, T_J .

In other applications, a heat sink or other thermally conductive path can be added to the top of the HSBGA package to remove heat. In those cases, θ_{JC1} can be used along with the thermal parameters for the heat sink or other thermal coupling added. Representative heat sinks which might be used with the ADC12D800/500RF include the Cool Innovations p/n 3-1212XXG and similar products from other vendors. In many applications, the printed circuit board will provide the primary thermal path conducting heat away from the ADC package. In those cases, θ_{JC2} can be used in conjunction with printed circuit board thermal modeling software to determine the allowed operating conditions that will maintain the die temperature below the maximum allowable limit. Additional dissipation can be achieved by coupling a heat sink to the copper pour area on the bottom side of the printed circuit board.

Typically, dissipation will occur through one predominant thermal path. In these cases, the following calculations can be used to determine the maximum safe ambient operating temperature for the ADC12D500RF, for example:

$$T_J = T_A + P_D \times (\theta_{JC} + \theta_{CA})$$

$$T_J = T_A + P_{C(MAX)} \times (\theta_{JC} + \theta_{CA})$$

For θ_{JC} , the value for the primary thermal path in the given application environment should be used (θ_{JC1} or θ_{JC2}). θ_{CA} is the thermal resistance from the case to ambient, which would typically be that of the heat sink used. Using this relationship and the desired ambient temperature, the required heat sink thermal resistance can be found. Alternately, the heat sink thermal resistance can be used to find the maximum ambient temperature. For more complex systems, thermal modeling software can be used to evaluate the printed circuit board system and determine the expected junction temperature given the total system dissipation and ambient temperature.

6.4.6 SYSTEM POWER-ON CONSIDERATIONS

There are a couple important topics to consider associated with the system power-on event including configuration and calibration, and the Data Clock.

6.4.6.1 Power-on, Configuration, and Calibration

Following the application of power to the ADC12D800/500RF, several events must take place before the output from the ADC12D800/500RF is valid and at full performance; at least one full calibration must be executed with the device configured in the desired mode.

Following the application of power to the ADC12D800/500RF, there is a delay of t_{CalDly} and then the Power-on Calibration is executed. This is why it is recommended to set the CalDly Pin via an external pull-up or pull-down resistor. This ensures that the state of that input will be properly set at the same time that power is applied to the ADC and t_{CalDly} will be a known quantity. For the purpose of this section, it is assumed that CalDly is set as recommended.

The Control Bits or Pins must be set or written to configure the ADC12D800/500RF in the desired mode. This must take place via either Extended Control Mode or Non-ECM (Pin Control Mode) before subsequent calibrations will yield an output at full performance in that mode. Some examples of modes include DES/Non-DES Mode, Demux/Non-demux Mode, and Full-Scale Range.

The simplest case is when device is in Non-ECM and the Control Pins are set by pull-up/down resistors, see [Figure 6-12](#). For this case, the settings to the Control Pins ramp concurrently to the ADC voltage. Following the delay of t_{CalDly} and the calibration execution time, t_{CAL} , the output of the ADC12D800/500RF is valid and at full performance. If it takes longer than t_{CalDly} for the system to stabilize at its operating temperature, it is recommended to execute an on-command calibration at that time.

Another case is when the FPGA configures the Control Pins (Non-ECM) or writes to the SPI (ECM), see [Figure 6-13](#). It is always necessary to comply with the Operating Ratings and Absolute Maximum ratings, i.e. the Control Pins may not be driven below the ground or above the supply, regardless of what the voltage currently applied to the supply is. Therefore, it is not recommended to write to the Control Pins or SPI before power is applied to the ADC12D800/500RF. As long as the FPGA has completed writing to the Control Pins or SPI, the Power-on Calibration will result in a valid output at full performance. Once again, if it takes longer than t_{CalDly} for the system to stabilize at its operating temperature, it is recommended to execute an on-command calibration at that time.

Due to system requirements, it may not be possible for the FPGA to write to the Control Pins or SPI before the Power-on Calibration takes place, see [Figure 6-14](#). It is not critical to configure the device before the Power-on Calibration, but it is critical to realize that the output for such a case is not at its full performance. Following an On-command Calibration, the device will be at its full performance.

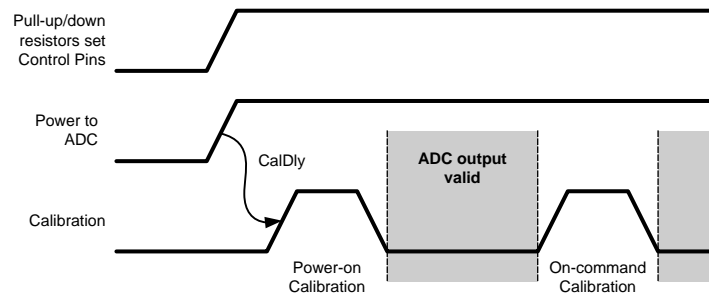

Figure 6-12. Power-on with Control Pins set by Pull-up/down Resistors

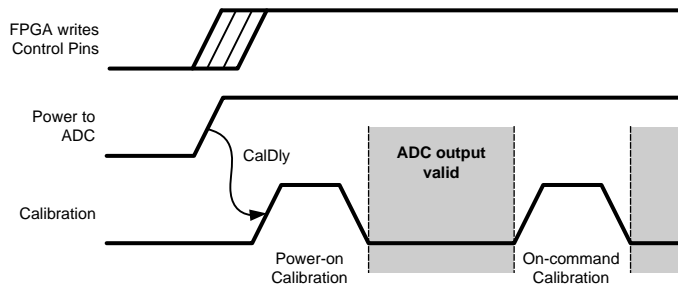

Figure 6-13. Power-on with Control Pins set by FPGA pre Power-on Cal

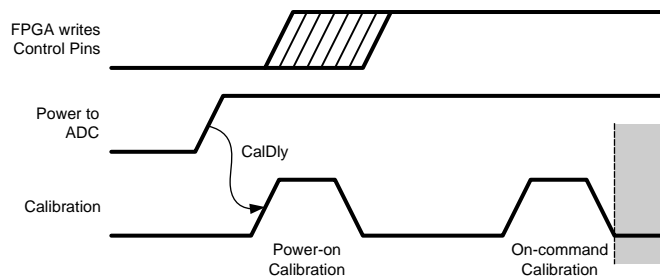

Figure 6-14. Power-on with Control Pins set by FPGA post Power-on Cal

6.4.6.2 Power-on and Data Clock (DCLK)

Many applications use the DCLK output for a system clock. For the ADC12D800/500RF, each I- and Q-channel has its own DCLKI and DCLKQ, respectively. The DCLK output is always active, unless that channel is powered-down or the DCLK Reset feature is used while the device is in Demux Mode. As the supply to the ADC12D800/500RF ramps, the DCLK also comes up, see this example from the ADC12D800RFRB: [Figure 6-15](#). While the supply is too low, there is no output at DCLK. As the supply continues to ramp, DCLK functions intermittently with irregular frequency, but the amplitude continues to track with the supply. Much below the low end of operating supply range of the ADC12D800/500RF, the DCLK is already fully operational.

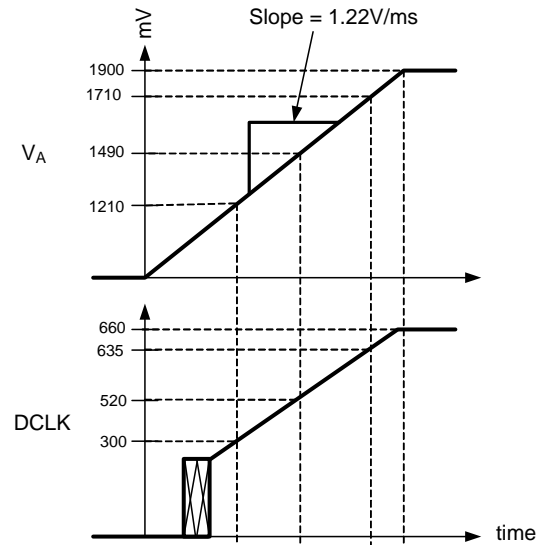

Figure 6-15. Supply and DCLK Ramping

6.4.7 RECOMMENDED SYSTEM CHIPS

TI recommends these other chips including temperature sensors, clocking devices, and amplifiers in order to support the ADC12D800/500RF in a system design.

6.4.7.1 Temperature Sensor

The ADC12D800/500RF has an on-die temperature diode connected to pins Tdiode+/- which may be used to monitor the die temperature. TI also provides a family of temperature sensors for this application which monitor different numbers of external devices, see [Table 6-11](#).

Table 6-11. Temperature Sensor Recommendation

Number of External Devices Monitored	Recommended Temperature Sensor
1	LM95235
2	LM95213
4	LM95214

The temperature sensor (LM95235/13/14) is an 11-bit digital temperature sensor with a 2-wire System Management Bus (SMBus) interface that can monitor the temperature of one, two, or four remote diodes as well as its own temperature. It can be used to accurately monitor the temperature of up to one, two, or four external devices such as the ADC12D800/500RF, a FPGA, other system components, and the ambient temperature.

The temperature sensor reports temperature in two different formats for +127.875°C/-128°C range and 0°/255°C range. It has a Sigma-Delta ADC core which provides the first level of noise immunity. For improved performance in a noisy environment, the temperature sensor includes programmable digital filters for Remote Diode temperature readings. When the digital filters are invoked, the resolution for the Remote Diode readings increases to 0.03125°C. For maximum flexibility and best accuracy, the temperature sensor includes offset registers that allow calibration for other types of diodes.

Diode fault detection circuitry in the temperature sensor can detect the absence or fault state of a remote diode: whether D+ is shorted to the power supply, D- or ground, or floating.

In the following typical application, the LM95213 is used to monitor the temperature of an ADC12D800/500RF as well as an FPGA, see Figure 6-16. If this feature is unused, the Tdiode+/- pins may be left floating.

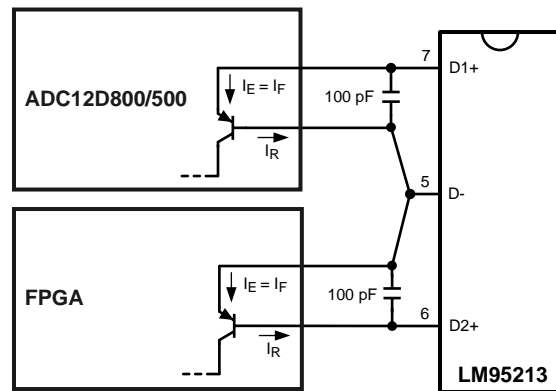

Figure 6-16. Typical Temperature Sensor Application

6.4.7.2 Clocking Device

The clock source can be a PLL/VCO device such as the LMX2531LQxxx family of products. The specific device should be selected according to the desired ADC sampling clock frequency. The ADC12D800RFRB uses the LMX2531LQ1570E, with the ADC clock source provided by the Aux PLL output. Other devices which may be considered based on clock source, jitter cleaning, and distribution purposes are the LMK01XXX, LMK02XXX, LMK03XXX and LMK04XXX product families.

6.4.7.3 Amplifiers for the Analog Input

The following amplifiers can be used for ADC12D800/500RF applications which require DC coupled input or signal gain, neither of which can be provided with a transformer coupled input circuit:

Table 6-12. Amplifier Recommendations

Amplifier	Bandwidth	Brief features
LMH6552	1.5 GHz	Configurable gain
LMH6553	900 MHz	Output clamp and configurable gain
LMH6554	2.8 GHz	Configurable gain
LMH6555	1.2 GHz	Fixed gain

6.4.7.4 Balun Recommendations for Analog Input

The following baluns are recommended for the ADC12D800/500RF for applications which require no gain. When evaluating a balun for the application of driving an ADC, some important qualities to consider are phase error and magnitude error.

Table 6-13. Balun Recommendations

Balun	Bandwidth
Mini Circuits TC1-1-13MA+	4.5 - 3000MHz
Anaren B0430J50100A00	400 - 3000 MHz
Mini Circuits ADTL2-18	30 - 1800 MHz

6.5 Register Definitions

Ten read/write registers provide several control and configuration options in the Extended Control Mode. These registers have no effect when the device is in the Non-extended Control Mode. Each register description below also shows the Power-On Reset (POR) state of each control bit. See [Table 6-14](#) for a summary.

Table 6-14. Register Addresses

A3	A2	A1	A0	Hex	Register Addressed
0	0	0	0	0h	Configuration Register 1
0	0	0	1	1h	Reserved
0	0	1	0	2h	I-channel Offset Adjust
0	0	1	1	3h	I-channel Full-Scale Range Adjust
0	1	0	0	4h	Calibration Adjust
0	1	0	1	5h	Calibration Values
0	1	1	0	6h	Reserved
0	1	1	1	7h	DES Timing Adjust
1	0	0	0	8h	Reserved
1	0	0	1	9h	Reserved
1	0	1	0	Ah	Q-channel Offset Adjust
1	0	1	1	Bh	Q-channel Full-Scale Range Adjust
1	1	0	0	Ch	Aperture Delay Coarse Adjust
1	1	0	1	Dh	Aperture Delay Fine Adjust
1	1	1	0	Eh	AutoSync
1	1	1	1	Fh	Reserved

Table 6-15. Configuration Register 1

Addr: 0h (0000b)									POR state: 2000h							
Bit	15	14	13	12	11	10	9	8	7	6	5	4	3	2	1	0
Name	CAL	DPS	OVS	TPM	PDI	PDQ	Res	Res	DES	DEQ	DIQ	2SC	TSE	SDR	Res	
POR	0	0	1	0	0	0	0	0	0	0	0	0	0	0	0	0
Bit 15	CAL: Calibration Enable. When this bit is set to 1b , an on-command calibration is initiated. This bit is not reset automatically upon completion of the calibration. Therefore, the user must reset this bit to 0b and then set it to 1b again to execute another calibration. This bit is logically OR'd with the CAL Pin; both bit and pin must be set to 0b before either is used to execute a calibration. ⁽¹⁾															
Bit 14	DPS: DCLK Phase Select. In DDR, set this bit to 0b to select the 0° Mode DDR Data-to-DCLK phase relationship and to 1b to select the 90° Mode. Note that for 1:2 Demux Mode, the Dual Data Rate (DDR) is not available. In SDR, set this bit to 0b to transition the data on the Rising edge of DCLK; set this bit to 1b to transition the data on the Falling edge of DCLK. ⁽¹⁾															
Bit 13	OVS: Output Voltage Select. This bit sets the differential voltage level for the LVDS outputs including Data, OR, and DCLK. 0b selects the lower level and 1b selects the higher level. See V _{OD} in Converter Electrical Characteristics Digital Control and Output Pin Characteristics for details.															
Bit 12	TPM: Test Pattern Mode. When this bit is set to 1b , the device will continually output a fixed digital pattern at the digital Data and OR outputs. When set to 0b , the device will continually output the converted signal, which was present at the analog inputs. See Test Pattern Mode for details about the TPM pattern.															
Bit 11	PDI: Power-down I-channel. When this bit is set to 0b , the I-channel is fully operational; when it is set to 1b , the I-channel is powered-down. The I-channel may be powered-down via this bit or the PDI Pin, which is active, even in ECM.															
Bit 10	PDQ: Power-down Q-channel. When this bit is set to 0b , the Q-channel is fully operational; when it is set to 1b , the Q-channel is powered-down. The Q-channel may be powered-down via this bit or the PDQ Pin, which is active, even in ECM.															
Bit 9	Reserved. Must be set as shown.															
Bit 8	Reserved. Must be set as shown.															
Bit 7	DES: Dual-Edge Sampling Mode select. When this bit is set to 0b , the device will operate in the Non-DES Mode; when it is set to 1b , the device will operate in the DES Mode. See DES/Non-DES Mode for more information.															

(1) This pin/bit functionality is not tested in production test; performance is tested in the specified/default mode only.

Bit 6	DEQ: DES Q-input select, a.k.a. DESQ Mode. When the device is in DES Mode, this bit selects the input that the device will operate on. The default setting of 0b selects the I-input and 1b selects the Q-input.		
Bit 5	DIQ: DES I- and Q-input, a.k.a. DESIQ Mode. When in DES Mode, setting this bit to 1b shorts the I- and Q-inputs internally to the device. If the bit is left at its default 0b , the I- and Q-inputs remain electrically separate. In this mode, both the I- and Q-inputs must be externally driven; see DES/Non-DES Mode for more information. ⁽¹⁾ The allowed DES Modes settings are shown below. For DESCLKIQ Mode, see Addr Eh.		
	Mode	Addr 0h, Bit<7:5>	Addr Eh, Bit<6>
	Non-DES Mode	000 b	0 b
	DESI Mode	100 b	0 b
	DESQ Mode	110 b	0 b
	DESIQ Mode	101 b	0 b
Bit 4	2SC: Two's Complement output. For the default setting of 0b , the data is output in Offset Binary format; when set to 1b , the data is output in Two's Complement format. ⁽¹⁾		
Bit 3	TSE: Time Stamp Enable. For the default setting of 0b , the Time Stamp feature is not enabled; when set to 1b , the feature is enabled. See Output Control and Adjust for more information about this feature. ⁽²⁾		
Bit 2	SDR: Single Data Rate. For the default setting of 0b , the data is clocked in Dual Data Rate; when set to 1b , the data is clocked in Single Data Rate. See Output Control and Adjust for more information about this feature. Note that for DDR Mode, the 1:2 Demux Mode is not available. See Table 6-5 for a selection of available modes.		
Bits 1:0	Reserved. Must be set as shown.		

(2) This pin/bit functionality is not tested in production test; performance is tested in the specified/default mode only.

Table 6-16. Reserved

Addr: 1h (0001b)									POR state: 2907h							
Bit	15	14	13	12	11	10	9	8	7	6	5	4	3	2	1	0
Name	Res															
POR	0	0	1	0	1	0	0	1	0	0	0	0	0	1	1	1
Bits 15:0	Reserved. Must be set as shown.															

Table 6-17. I-channel Offset Adjust

Addr: 2h (0010b)									POR state: 0000h							
Bit	15	14	13	12	11	10	9	8	7	6	5	4	3	2	1	0
Name	Res			OS	OM(11:0)											
POR	0	0	0	0	0	0	0	0	0	0	0	0	0	0	0	0
Bits 15:13	Reserved. Must be set to 0b .															
Bit 12	OS: Offset Sign. The default setting of 0b incurs a positive offset of a magnitude set by Bits 11:0 to the ADC output. Setting this bit to 1b incurs a negative offset of the set magnitude.															
Bits 11:0	OM(11:0): Offset Magnitude. These bits determine the magnitude of the offset set at the ADC output (straight binary coding). The range is from 0 mV for OM(11:0) = 0d to 45 mV for OM(11:0) = 4095d in steps of ~11 μ V. Monotonicity is specified by design only for the 9 MSBs.															
	Code								Offset [mV]							
	0000 0000 0000 (default)								0							
	1000 0000 0000								22.5							
	1111 1111 1111								45							

Table 6-18. I-channel Full Scale Range Adjust

Addr: 3h (0011b)									POR state: 4000h							
Bit	15	14	13	12	11	10	9	8	7	6	5	4	3	2	1	0
Name	Res	FM(14:0)														
POR	0	1	0	0	0	0	0	0	0	0	0	0	0	0	0	0

Bit 15	Reserved. Must be set to 0b.	
Bits 14:0	FM(14:0): FSR Magnitude. These bits increase the ADC full-scale range magnitude (straight binary coding.) The range is from 600 mV (0d) to 1000 mV (32767d) with the default setting at 800 mV (16384d). Monotonicity is specified by design only for the 9 MSBs. The mid-range (low) setting in ECM corresponds to the nominal (low) setting in Non-ECM. A greater range of FSR values is available in ECM, i.e. FSR values above 800 mV. See V_{IN_FSR} in Converter Electrical Characteristics Analog Input/Output and Reference Characteristics for characterization details.	
	Code	FSR [mV]
	000 0000 0000 0000	600
	100 0000 0000 0000 (default)	800
	111 1111 1111 1111	1000

Table 6-19. Calibration Adjust⁽¹⁾

Addr: 4h (0100b)									POR state: DB4Bh							
Bit	15	14	13	12	11	10	9	8	7	6	5	4	3	2	1	0
Name	Res	CSS	Res					SSC	Res							
POR	1	1	0	1	1	0	1	1	0	1	0	0	1	0	1	1

(1) This feature functionality is not tested in production test; performance is tested in the specified/default mode only.

Bit 15	Reserved. Must be set as shown.															
Bit 14	CSS: Calibration Sequence Select. The default 1b selects the following calibration sequence: reset all previously calibrated elements to nominal values, do R_{IN} Calibration, do internal linearity Calibration. Setting CSS = 0b selects the following calibration sequence: do not reset R_{IN} to its nominal value, skip R_{IN} calibration, do internal linearity Calibration. The calibration must be completed at least one time with CSS = 1b to calibrate R_{IN} . Subsequent calibrations may be run with CSS = 0b (skip R_{IN} calibration) or 1b (full R_{IN} and internal linearity Calibration).															
Bits 13:8	Reserved. Must be set as shown.															
Bit 7	SSC: SPI Scan Control. Setting this control bit to 1b allows the calibration values, stored in Addr: 5h, to be read/written. When not reading/writing the calibration values, this control bit should left at its default 0b setting. See Calibration Feature for more information.															
Bits 6:0	Reserved. Must be set as shown.															

Table 6-20. Calibration Values⁽¹⁾

Addr: 5h (0101b)									POR state: XXXXh							
Bit	15	14	13	12	11	10	9	8	7	6	5	4	3	2	1	0
Name	SS(15:0)															
POR	X	X	X	X	X	X	X	X	X	X	X	X	X	X	X	X

(1) This feature functionality is not tested in production test; performance is tested in the specified/default mode only.

Bits 15:0	SS(15:0): SPI Scan. When the ADC performs a self-calibration, the values for the calibration are stored in this register and may be read from/ written to it. Set SSC (Addr: 4h, Bit 7) to read/write. See Calibration Feature for more information.															
-----------	--	--	--	--	--	--	--	--	--	--	--	--	--	--	--	--

Table 6-21. Reserved - ADC12D800RF

Addr: 6h (0110b)									POR state: 1C2Eh							
Bit	15	14	13	12	11	10	9	8	7	6	5	4	3	2	1	0
Name	Res															
POR	0	0	0	1	1	1	0	0	0	0	1	0	1	1	1	0
Bits 15:0	Reserved. Must be set as shown.															

Table 6-22. Reserved - ADC12D500RF

Addr: 6h (0110b)									POR state: 1C6Eh							
Bit	15	14	13	12	11	10	9	8	7	6	5	4	3	2	1	0
Name	Res															
POR	0	0	0	1	1	1	0	0	0	1	1	0	1	1	1	0

Bits 15:0	Reserved. Must be set as shown. Although Bits 6 and 5 may be written to / read from the Control Registers, its final internal value is set in hardware.
-----------	---

Table 6-23. DES Timing Adjust⁽¹⁾

Addr: 7h (0111b)									POR state: 8142h							
Bit	15	14	13	12	11	10	9	8	7	6	5	4	3	2	1	0
Name	DTA(6:0)								Res							
POR	1	0	0	0	0	0	0	1	0	1	0	0	0	0	1	0

(1) This feature functionality is not tested in production test; performance is tested in the specified/default mode only.

Bits 15:9	DTA(6:0): DES Mode Timing Adjust. In the DES Mode, the time at which the falling edge sampling clock samples relative to the rising edge of the sampling clock may be adjusted; the automatic duty cycle correction continues to function. See Input Control and Adjust for more information. The nominal step size is 30fs.
Bits 8:0	Reserved. Must be set as shown.

Table 6-24. Reserved

Addr: 8h (1000b)									POR state: 0F0Fh							
Bit	15	14	13	12	11	10	9	8	7	6	5	4	3	2	1	0
Name	Res															
POR	0	0	0	0	1	1	1	1	0	0	0	0	1	1	1	1
Bits 15:0	Reserved. Must be set as shown.															

Table 6-25. Reserved

Addr: 9h (1001b)									POR state: 0000h							
Bit	15	14	13	12	11	10	9	8	7	6	5	4	3	2	1	0
Name	Res															
POR	0	0	0	0	0	0	0	0	0	0	0	0	0	0	0	0
Bits 15:0	Reserved. Must be set as shown.															

Table 6-26. Q-channel Offset Adjust

Addr: Ah (1010b)									POR state: 0000h							
Bit	15	14	13	12	11	10	9	8	7	6	5	4	3	2	1	0
Name	Res			OS	OM(11:0)											
POR	0	0	0	0	0	0	0	0	0	0	0	0	0	0	0	0
Bits 15:13	Reserved. Must be set to 0b.															
Bit 12	OS: Offset Sign. The default setting of 0b incurs a positive offset of a magnitude set by Bits 11:0 to the ADC output. Setting this bit to 1b incurs a negative offset of the set magnitude.															
Bits 11:0	OM(11:0): Offset Magnitude. These bits determine the magnitude of the offset set at the ADC output (straight binary coding). The range is from 0 mV for OM(11:0) = 0d to 45 mV for OM(11:0) = 4095d in steps of ~11 μV. Monotonicity is specified by design only for the 9 MSBs.															
	Code								Offset [mV]							
	0000 0000 0000 (default)								0							
	1000 0000 0000								22.5							
	1111 1111 1111								45							

Table 6-27. Q-channel Full-Scale Range Adjust

Addr: Bh (1011b)									POR state: 4000h							
Bit	15	14	13	12	11	10	9	8	7	6	5	4	3	2	1	0
Name	Res	FM(14:0)														
POR	0	1	0	0	0	0	0	0	0	0	0	0	0	0	0	0
Bit 15	Reserved. Must be set to 0b.															
Bits 14:0	FM(14:0): FSR Magnitude. These bits increase the ADC full-scale range magnitude (straight binary coding.) The range is from 600 mV (0d) to 1000 mV (32767d) with the default setting at 800 mV (16384d). Monotonicity is specified by design only for the 9 MSBs. The mid-range (low) setting in ECM corresponds to the nominal (low) setting in Non-ECM. A greater range of FSR values is available in ECM, i.e. FSR values above 800 mV. See V_{IN_FSR} in Converter Electrical Characteristics Analog Input/Output and Reference Characteristics for characterization details.															
	Code								FSR [mV]							
	000 0000 0000 0000								600							
	100 0000 0000 0000 (default)								800							
	111 1111 1111 1111								1000							

Table 6-28. Aperture Delay Coarse Adjust

Addr: Ch (1100b)									POR state: 0004h							
Bit	15	14	13	12	11	10	9	8	7	6	5	4	3	2	1	0
Name	CAM(11:0)												STA	DCC	Res	
POR	0	0	0	0	0	0	0	0	0	0	0	0	0	1	0	0
Bits 15:4	CAM(11:0): Coarse Adjust Magnitude. This 12-bit value determines the amount of delay that will be applied to the input CLK signal. The range is 0 ps delay for CAM(11:0) = 0d to a maximum delay of 825 ps for CAM(11:0) = 2431d (± 95 ps due to PVT variation) in steps of ~ 340 fs. For code CAM(11:0) = 2432d and above, the delay saturates and the maximum delay applies. Additional, finer delay steps are available in register Dh. Either STA (Bit 3) or SA (Addr: Dh, Bit 8) must be selected to enable this function.															
Bit 3	STA: Select t_{AD} Adjust. Set this bit to 1b to enable the t_{AD} adjust feature, which will make both coarse and fine adjustment settings, i.e. CAM(11:0) and FAM(5:0), available.															
Bit 2	DCC: Duty Cycle Correct. This bit can be set to 0b to disable the automatic duty-cycle stabilizer feature of the chip. This feature is enabled by default.															
Bits 1:0	Reserved. Must be set to 0b.															

Table 6-29. Aperture Delay Fine Adjust

Addr: Dh (1101b)									POR state: 0000h							
Bit	15	14	13	12	11	10	9	8	7	6	5	4	3	2	1	0
Name	FAM(5:0)						Res	SA	Res							
POR	0	0	0	0	0	0	0	0	0	0	0	0	0	0	0	0
Bits 15:10	FAM(5:0): Fine Aperture Adjust Magnitude. This 6-bit value determines the amount of additional delay that will be applied to the input CLK when the Clock Phase Adjust feature is enabled via STA (Addr: Ch, Bit 3) or SA (Addr: Dh, Bit 8). The range is straight binary from 0 ps delay for FAM(5:0) = 0d to 2.3 ps delay for FAM(5:0) = 63d (± 300 fs due to PVT variation) in steps of ~ 36 fs.															
Bit 9	Reserved. Must be set to 0b.															
Bit 8	SA: Select t_{AD} Adjust. Set this bit to 1b to enable the t_{AD} adjust feature. This bit is the same as STA (Addr: Ch, Bit 3), except that if SA is enabled, then the value of the STA bit is ignored.															
Bits 7:0	Reserved. Must be set as shown.															

Table 6-30. AutoSync⁽¹⁾

Addr: Eh (1110b)									POR state: 0003h							
Bit	15	14	13	12	11	10	9	8	7	6	5	4	3	2	1	0
Name	DRC(8:0)								DCK	Res	SP(1:0)			ES	DOC	DR
POR	0	0	0	0	0	0	0	0	0	0	0	0	0	0	1	1

(1) This feature functionality is not tested in production test; performance is tested in the specified/default mode only.

Bits 15:7	DRC(8:0): Delay Reference Clock (8:0). These bits may be used to increase the delay on the input reference clock when synchronizing multiple ADCs. The delay may be set from a minimum of 0s (0d) to a maximum of 1200 ps (319d). The delay remains the maximum of 1200 ps for any codes above or equal to 319d. See SYNCHRONIZING MULTIPLE ADC12D800/500RFS IN A SYSTEM for more information.
Bit 6	DCK: DESCLKIQ Mode. Set this bit to 1b to enable Dual-Edge Sampling, in which the Sampling Clock samples the I- and Q-channels 180° out of phase with respect to one another, i.e. the DESCLKIQ Mode. To select the DESCLKIQ Mode, Addr: 0h, Bits <7:5> must also be set to 000b. See Input Control and Adjust for more information. ⁽¹⁾
Bit 5	Reserved. Must be set as shown.
Bits 4:3	SP(1:0): Select Phase. These bits select the phase of the reference clock which is latched. The codes correspond to the following phase shift: 00 = 0° 01 = 90° 10 = 180° 11 = 270°
Bit 2	ES: Enable Slave. Set this bit to 1b to enable the Slave Mode of operation. In this mode, the internal divided clocks are synchronized with the reference clock coming from the master ADC. The master clock is applied on the input pins RCLK. If this bit is set to 0b, then the device is in Master Mode.
Bit 1	DOC: Disable Output reference Clocks. Setting this bit to 0b sends a CLK/4 signal on RCOut1 and RCOut2. The default setting of 1b disables these output drivers. This bit functions as described, regardless of whether the device is operating in Master or Slave Mode, as determined by ES (Bit 2).
Bit 0	DR: Disable Reset. The default setting of 1b leaves the DCLK_RST functionality disabled. Set this bit to 0b to enable DCLK_RST functionality.

(1) This feature functionality is not tested in production test; performance is tested in the specified/default mode only.

Table 6-31. Reserved

Addr: Fh (1111b)									POR state: 001Dh							
Bit	15	14	13	12	11	10	9	8	7	6	5	4	3	2	1	0
Name	Res															
POR	0	0	0	0	0	0	0	0	0	0	0	1	1	1	0	1
Bits 15:0	Reserved. This address is read only.															

Revision History

NOTE: Page numbers for previous revisions may differ from page numbers in the current version.

Changes from Revision D (March 2013) to Revision E	Page
<ul style="list-style-type: none">Changed layout of National Data Sheet to TI format	74

PACKAGING INFORMATION

Orderable Device	Status (1)	Package Type	Package Drawing	Pins	Package Qty	Eco Plan (2)	Lead finish/ Ball material (6)	MSL Peak Temp (3)	Op Temp (°C)	Device Marking (4/5)	Samples
ADC12D500RFIUT	ACTIVE	BGA	NXA	292	40	Non-RoHS & Green	Call TI	Level-3-220C-168 HR	-40 to 85	ADC12D500RFIUT	Samples
ADC12D500RFIUT/NOPB	ACTIVE	BGA	NXA	292	40	RoHS & Green	SNAG	Level-3-250C-168 HR	-40 to 85	ADC12D500RFIUT	Samples
ADC12D800RFIUT	ACTIVE	BGA	NXA	292	40	Non-RoHS & Green	Call TI	Level-3-220C-168 HR	-40 to 85	ADC12D800RFIUT	Samples
ADC12D800RFIUT/NOPB	ACTIVE	BGA	NXA	292	40	RoHS & Green	SNAG	Level-3-250C-168 HR	-40 to 85	ADC12D800RFIUT	Samples

(1) The marketing status values are defined as follows:

ACTIVE: Product device recommended for new designs.

LIFEBUY: TI has announced that the device will be discontinued, and a lifetime-buy period is in effect.

NRND: Not recommended for new designs. Device is in production to support existing customers, but TI does not recommend using this part in a new design.

PREVIEW: Device has been announced but is not in production. Samples may or may not be available.

OBSELETE: TI has discontinued the production of the device.

(2) **RoHS:** TI defines "RoHS" to mean semiconductor products that are compliant with the current EU RoHS requirements for all 10 RoHS substances, including the requirement that RoHS substance do not exceed 0.1% by weight in homogeneous materials. Where designed to be soldered at high temperatures, "RoHS" products are suitable for use in specified lead-free processes. TI may reference these types of products as "Pb-Free".

RoHS Exempt: TI defines "RoHS Exempt" to mean products that contain lead but are compliant with EU RoHS pursuant to a specific EU RoHS exemption.

Green: TI defines "Green" to mean the content of Chlorine (Cl) and Bromine (Br) based flame retardants meet JS709B low halogen requirements of <=1000ppm threshold. Antimony trioxide based flame retardants must also meet the <=1000ppm threshold requirement.

(3) MSL, Peak Temp. - The Moisture Sensitivity Level rating according to the JEDEC industry standard classifications, and peak solder temperature.

(4) There may be additional marking, which relates to the logo, the lot trace code information, or the environmental category on the device.

(5) Multiple Device Markings will be inside parentheses. Only one Device Marking contained in parentheses and separated by a "-" will appear on a device. If a line is indented then it is a continuation of the previous line and the two combined represent the entire Device Marking for that device.

(6) Lead finish/Ball material - Orderable Devices may have multiple material finish options. Finish options are separated by a vertical ruled line. Lead finish/Ball material values may wrap to two lines if the finish value exceeds the maximum column width.

Important Information and Disclaimer:The information provided on this page represents TI's knowledge and belief as of the date that it is provided. TI bases its knowledge and belief on information provided by third parties, and makes no representation or warranty as to the accuracy of such information. Efforts are underway to better integrate information from third parties. TI has taken and

continues to take reasonable steps to provide representative and accurate information but may not have conducted destructive testing or chemical analysis on incoming materials and chemicals. TI and TI suppliers consider certain information to be proprietary, and thus CAS numbers and other limited information may not be available for release.

In no event shall TI's liability arising out of such information exceed the total purchase price of the TI part(s) at issue in this document sold by TI to Customer on an annual basis.

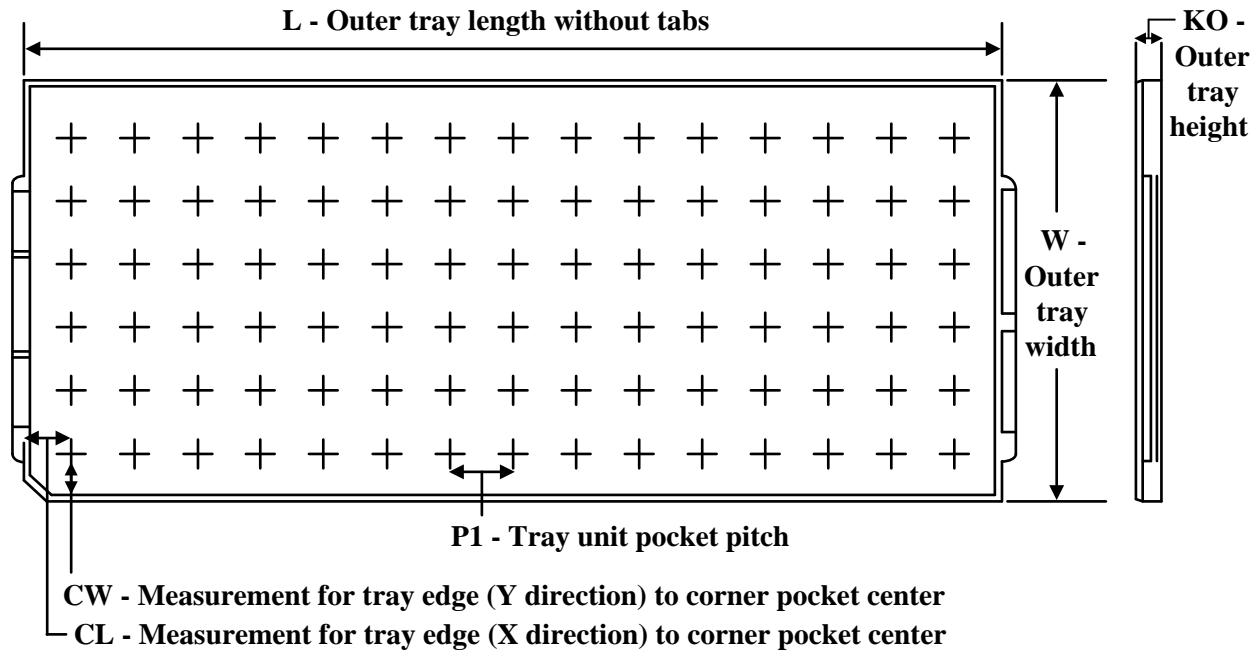
TRAY

Chamfer on Tray corner indicates Pin 1 orientation of packed units.

*All dimensions are nominal

Device	Package Name	Package Type	Pins	SPQ	Unit array matrix	Max temperature (°C)	L (mm)	W (mm)	K0 (µm)	P1 (mm)	CL (mm)	CW (mm)
ADC12D500RFIUT	NXA	BGA	292	40	4 X 10	150	322.6	135.9	7620	29.2	26.1	24.15
ADC12D500RFIUT/ NOPB	NXA	BGA	292	40	4 X 10	150	322.6	135.9	7620	29.2	26.1	24.15
ADC12D800RFIUT	NXA	BGA	292	40	4 X 10	150	322.6	135.9	7620	29.2	26.1	24.15
ADC12D800RFIUT/ NOPB	NXA	BGA	292	40	4 X 10	150	322.6	135.9	7620	29.2	26.1	24.15

NXA0292A

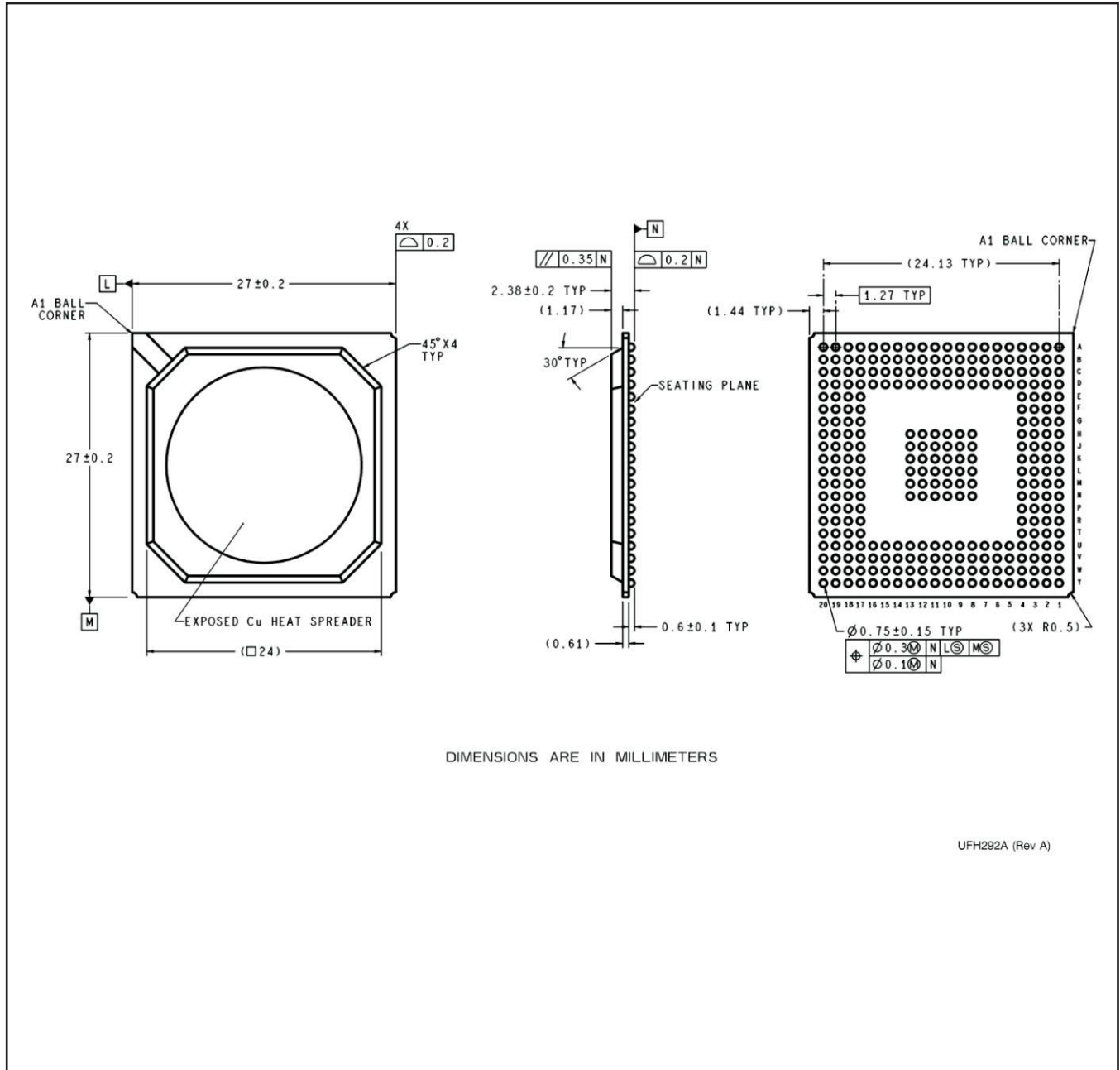

DIMENSIONS ARE IN MILLIMETERS

UFH292A (Rev A)

IMPORTANT NOTICE AND DISCLAIMER

TI PROVIDES TECHNICAL AND RELIABILITY DATA (INCLUDING DATA SHEETS), DESIGN RESOURCES (INCLUDING REFERENCE DESIGNS), APPLICATION OR OTHER DESIGN ADVICE, WEB TOOLS, SAFETY INFORMATION, AND OTHER RESOURCES "AS IS" AND WITH ALL FAULTS, AND DISCLAIMS ALL WARRANTIES, EXPRESS AND IMPLIED, INCLUDING WITHOUT LIMITATION ANY IMPLIED WARRANTIES OF MERCHANTABILITY, FITNESS FOR A PARTICULAR PURPOSE OR NON-INFRINGEMENT OF THIRD PARTY INTELLECTUAL PROPERTY RIGHTS.

These resources are intended for skilled developers designing with TI products. You are solely responsible for (1) selecting the appropriate TI products for your application, (2) designing, validating and testing your application, and (3) ensuring your application meets applicable standards, and any other safety, security, regulatory or other requirements.

These resources are subject to change without notice. TI grants you permission to use these resources only for development of an application that uses the TI products described in the resource. Other reproduction and display of these resources is prohibited. No license is granted to any other TI intellectual property right or to any third party intellectual property right. TI disclaims responsibility for, and you will fully indemnify TI and its representatives against, any claims, damages, costs, losses, and liabilities arising out of your use of these resources.

TI's products are provided subject to [TI's Terms of Sale](#) or other applicable terms available either on [ti.com](https://www.ti.com) or provided in conjunction with such TI products. TI's provision of these resources does not expand or otherwise alter TI's applicable warranties or warranty disclaimers for TI products.

TI objects to and rejects any additional or different terms you may have proposed.

Mailing Address: Texas Instruments, Post Office Box 655303, Dallas, Texas 75265
Copyright © 2023, Texas Instruments Incorporated