

DESCRIPTION : ABOVE PCB/BELOW PCB, DECK AND PUSH ROD LOCATION ARE AS VIEW BY USER.

PRODUCT NO.	PUSH ROD LOCATION	STAND-OFF HEIGHT	MATING RECEPTACLE	P.C.B SIDE	RECOMMENDED P.C.B LAYOUT	MOUNT STYLE TO PCB AND PUSH ROD SIDE
(A) 74054-*****			(B)			
000CAS	RIGHT	0.0	100 POSITIONS (2x50) 0.8mm RECEPTACLE PART NO. 73277-101402LF	ABOVE	SEE DRAWING NO.: TA-1050	
020CAS	RIGHT	2.0				
022CAS	RIGHT	2.2				
028CAS	RIGHT	2.8				
040CAS	RIGHT	4.0				
043CAS	RIGHT	4.3				
050CAS	RIGHT	5.0				
100CAS	LEFT	0.0				
120CAS	LEFT	2.0				
122CAS	LEFT	2.2				
128CAS	LEFT	2.8				
140CAS	LEFT	4.0				
143CAS	LEFT	4.3				
150CAS	LEFT	5.0				
022CAR	RIGHT	2.2				
122CAT	LEFT	2.2				
522CAS	RIGHT	2.2				
540CAS	RIGHT	4.0				
543CAS	RIGHT	4.3				
550CAS	RIGHT	5.0				
622CAS	LEFT	2.2				
640CAS	LEFT	4.0				
643CAS	LEFT	4.3				
650CAS	LEFT	5.0				

2-STEP CARDBUS WITH METAL COVER						
322CAS	LEFT	2.2	100 POSITIONS (2x50) 0.8mm RECEPTACLE PART NO.	ABOVE	SEE DRAWING NO.: TA-1050	

2-STEP CARDBUS WITH SPECIAL PUSH ROD						
740CAS-B	LEFT PUSH ROD COLOR :BLACK	4.0	100 POSITIONS (2x50) 0.8mm RECEPTACLE PART NO.	BELOW	SEE DRAWING NO.: TA-1050	
840CAS	RIGHT PUSH ROD COLOR :BLACK	4.0	100 POSITIONS (2x50) 0.8mm RECEPTACLE PART NO.	BELOW	SEE DRAWING NO.: TA-1050	
740CAS-BLF	LEFT PUSH ROD COLOR :BLACK (Lead-Free type)	4.0	100 POSITIONS (2x50) 0.8mm RECEPTACLE PART NO.	BELOW	SEE DRAWING NO.: TA-1050	
840CASLF	RIGHT PUSH ROD COLOR :BLACK (Lead-Free type)	4.0	100 POSITIONS (2x50) 0.8mm RECEPTACLE PART NO.	BELOW	SEE DRAWING NO.: TA-1050	

NOTES:

- 8.0mm MIN CARD EJECT.
- EJECT TRAVEL: 9.50mm
- MATERIAL:
 - 3.1 EJECT HEADER ASS'Y
 - PLASTIC HOUSING: HIGH TEMPERATURE THERMOPLASTIC UL94V-0 BLACK
 - PIN: COPPER ALLOY
 - PCB: FR4
 - PLASTIC GUIDE: HIGH TEMPERATURE THERMOPLASTIC UL94V-0 BLACK
 - PLATE: STAINLESS
 - EMI CONTACT: PHOSPHOR BRONZE
 - 3.2 RECEPTACLE
 - PLASTIC: HIGH TEMPERATURE THERMOPLASTIC UL94V-0 BLACK
 - PIN: BeCu
- FINISH
 - PIN :(FOR OTHER VERSIONS)
 - UNDER PLATING: 0.5um MIN. Ni
 - CONTACT AREA: 0.076 μm MIN. GOLD
 - PIN :(FOR LEAD-FREE TYPE)
 - UNDER PLATING: 1.27um MIN. Ni
 - CONTACT AREA: 0.076 μm MIN. GOLD
 - SOLDER TAIL: 2.5um MIN. PURE Tin.
 - GROUND SHIELD :
 - UNDER PLATING: 0.75um MIN. Ni
 - CONTACT SURFACE: 0.03um GOLD MIN. OVER PdNi 0.5um MIN.(GOLD FLASH DOUBLE SIDES) OR, 0.38um GOLD(ONE SIDE ONLY)
- PUSH ROD LOCATION AND P.C.B. ARE AS APPEARS INSTALLED
- DIM "X"

4.25±0.1	3.5±0.1	5.0±0.1
OTHERS	36,67	1,17,34,35,51,68
- DO NOT TOUCH AND KEEP CLEAN THE SURFACES OF PCB OF HEADER ASS'Y.
- P.C.B LAYOUT AND PIN ASSIGNMENT REFERED TO PART NUMBER TA-1050.
- PRODUCT SPEC:110-263

ORDERING INFORMATION

THREADED INSERT ASSEMBLED BY BERG		
NAME	PART NO.	Q'TY
(A) EJECT HEADER ASS'Y	74054-*****	1
(B) MATING RECEPTACLE	73277-101402LF	1

mat'l. code	surface	tolerance	projection	product family
	ISO 1302	ISO 406 ISO 1181		CARDBUS SINGLE DECK
ltr ecn no dr date	tolerances unless otherwise specified	title		
S N05-0087 WB 06/17/05	angles	CARDBUS SINGLE DECK		
T N05-0175 WB 03/23/05	linear ± 0.30	2-STEP, TYPE 1/2/3		
U N08-0028 MZ 02/22/08	±2'	scale		
V ELX-N-011416 ZK 04/07/12	dr WENDY CHEN 09/23/97	dwg no 74054 sheet 1 of 10 size A4		
	engr STELAR CHU 09/23/97	type CUSTOMER Drawing		
	chr JOSEPH HSIA 09/23/97			
	app JENN TSAO 09/23/97			
sheet revision	V V V V V V V V V V			
index sheet	1 2 3 4 5 6 7 8 9 10			

FCI CONFIDENTIAL

FCI

FCI

FCI

D

DESCRIPTION : ABOVE PCB/BELOW PCB, DECK AND PUSH ROD LOCATION ARE AS VIEW BY USER.

PRODUCT NO.	PUSH ROD LOCATION	STAND-OFF HEIGHT	MATING RECEPTACLE (B)	P.C.B SIDE	RECOMMENDED P.C.B LAYOUT	MOUNT STYLE TO PCB AND PUSH ROD SIDE				
(A) 74054-*****										
000CASLF	RIGHT	0.0	100 POSITIONS (2x50) 0.8mm RECEPTACLE PART NO. 73277-101402LF	ABOVE	SEE DRAWING NO.: TA-1050					
020CASLF	RIGHT	2.0								
022CASLF	RIGHT	2.2								
028CASLF	RIGHT	2.8								
040CASLF	RIGHT	4.0								
043CASLF	RIGHT	4.3								
050CASLF	RIGHT	5.0								
100CASLF	LEFT	0.0								
120CASLF	LEFT	2.0								
122CASLF	LEFT	2.2								
128CASLF	LEFT	2.8								
140CASLF	LEFT	4.0								
143CASLF	LEFT	4.3								
150CASLF	LEFT	5.0								
022CARLF	RIGHT	2.2	100 POSITIONS (2x50) 0.8mm RECEPTACLE PART NO. 73277-101402LF	BELOW	SEE DRAWING NO.: TA-1050					
122CATLF	LEFT	2.2								
522CASLF	RIGHT	2.2								
540CASLF	RIGHT	4.0								
543CASLF	RIGHT	4.3								
550CASLF	RIGHT	5.0								
622CASLF	LEFT	2.2								
640CASLF	LEFT	4.0								
643CASLF	LEFT	4.3								
650CASLF	LEFT	5.0								
322CASLF	LEFT	2.2					100 POSITIONS (2x50) 0.8mm RECEPTACLE PART NO.	ABOVE	SEE DRAWING NO.: TA-1050	
740CAS-B	LEFT PUSH ROD COLOR :BLACK	4.0					100 POSITIONS (2x50) 0.8mm RECEPTACLE PART NO.	BELOW	SEE DRAWING NO.: TA-1050	
840CAS	RIGHT PUSH ROD COLOR :BLACK	4.0					100 POSITIONS (2x50) 0.8mm RECEPTACLE PART NO.	BELOW	SEE DRAWING NO.: TA-1050	
740CAS-BLF	LEFT PUSH ROD COLOR :BLACK (Lead-Free type)	4.0					100 POSITIONS (2x50) 0.8mm RECEPTACLE PART NO.	BELOW	SEE DRAWING NO.: TA-1050	
840CASLF	RIGHT PUSH ROD COLOR :BLACK (Lead-Free type)	4.0	100 POSITIONS (2x50) 0.8mm RECEPTACLE PART NO.	BELOW	SEE DRAWING NO.: TA-1050					

2-STEP CARDBUS WITH METAL COVER

2-STEP CARDBUS WITH SPECIAL PUSH ROD

NOTES:

- 8.0mm MIN CARD EJECT.
- EJECT TRAVEL: 9.50mm
- MATERIAL:
 - 3.1 EJECT HEADER ASS'Y
 - PLASTIC HOUSING: HIGH TEMPERATURE THERMOPLASTIC UL94V-0 BLACK
 - PIN: COPPER ALLOY
 - PCB: FR4
 - PLASTIC GUIDE: HIGH TEMPERATURE THERMOPLASTIC UL94V-0 BLACK
 - PLATE: STAINLESS
 - EMI CONTACT: PHOSPHOR BRONZE
 - 3.2 RECEPTACLE
 - PLASTIC: HIGH TEMPERATURE THERMOPLASTIC UL94V-0 BLACK
 - PIN: BeCu
- FINISH
 - PIN :(FOR OTHER VERSIONS)
 - UNDER PLATING: 0.5um MIN. Ni
 - CONTACT AREA: 0.076 μm MIN. GOLD
 - PIN :(FOR LEAD-FREE TYPE)
 - UNDER PLATING: 1.27um MIN. Ni
 - CONTACT AREA: 0.076 μm MIN. GOLD
 - SOLDER TAIL: 2.5um MIN. PURE Tin.
 - GROUND SHIELD :
 - UNDER PLATING: 0.75um MIN. Ni
 - CONTACT SURFACE: 0.03um GOLD MIN. OVER PdNi 0.5um MIN.(GOLD FLASH DOUBLE SIDES) OR, 0.38um GOLD(ONE SIDE ONLY)
- PUSH ROD LOCATION AND P.C.B. ARE AS APPEARS INSTALLED
- DIM "X"

4.25±0.1	3.5±0.1	5.0±0.1
OTHERS	36,67	1,17,34,35,51,68
- DO NOT TOUCH AND KEEP CLEAN THE SURFACES OF PCB OF HEADER ASS'Y.
- P.C.B LAYOUT AND PIN ASSIGNMENT REFERED TO PART NUMBER TA-1050.
- IF LEAD FREE P.N.THE HOUSING WILL WITHSTAND EXPOSURE TO 260°C PEAK TEMPERATURE FOR 10 SECONDS IN A WAVE SOLDER APPLICATION WITH A 1.00MM MINIMUM THICK CIRCUIT BOARD.
- IF LEAD FREE P/N.THE PRODUCT MEETS EUROPEAN UNION DIRECTIVES AND OTHER COUNTRY REGULATIONS AS DISCRIBLED IN GS-22-008
- LEAD FREE P/N PACKAGING MEETS GS-14-920 SPECIFICATION
- PRODUCT SPEC:110-263

ORDERING INFORMATION

THREADED INSERT ASSEMBLED BY BERG		
NAME	PART NO.	Q'TY
(A) EJECT HEADER ASS'Y	74054-*****LF	1
(B) MATING RECEPTACLE	73277-101402LF	1

mat'l. code	surface ISO 1302	tolerance ISO 406	projection ISO 1181	product family
ltr ecn nodr date	tolerances unless otherwise specified			title
v	angles	linear ± 0.30	MM	CARDBUS SINGLE DECK 2-STEP, TYPE 1/2/3
	±2'		scale	dwg no 74054 sheet 2 of 0 size A4
	dr WENDY CHEN 09/23/97	engr STELAR CHU 09/23/97	chr JOSEPH HSIA 09/23/97	type CUSTOMER Drawing
	app JENN TSAO 09/23/97			
sheet index	revision sheet			

FCI CONFIDENTIAL

FCI CONFIDENTIAL

This document is the property of and embodies CONFIDENTIAL and PROPRIETARY information of FCI. No part of this information shown on this document may be used in any way or disclosed to others without the written consent of FCI. Copyright FCI.

FCI CONFIDENTIAL



This document is the property of and embodies CONFIDENTIAL and PROPRIETARY information of FCI. No part of this information shown on this document may be used in any way or disclosed to others without the written consent of FCI.
Copyright FCI.

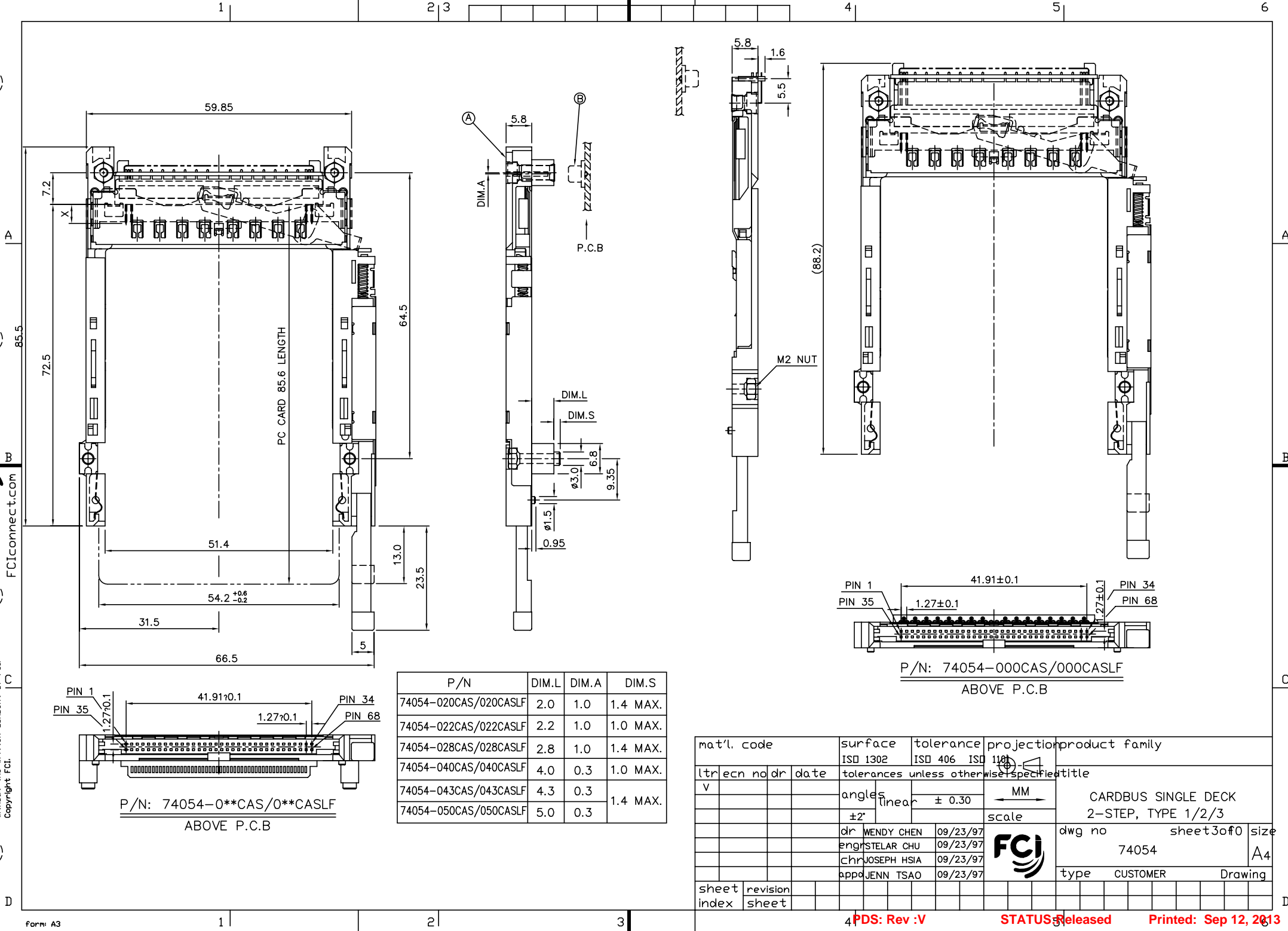

P/N	DIM.L	DIM.A	DIM.S
74054-020CAS/020CASLF	2.0	1.0	1.4 MAX.
74054-022CAS/022CASLF	2.2	1.0	1.0 MAX.
74054-028CAS/028CASLF	2.8	1.0	1.4 MAX.
74054-040CAS/040CASLF	4.0	0.3	1.0 MAX.
74054-043CAS/043CASLF	4.3	0.3	1.4 MAX.
74054-050CAS/050CASLF	5.0	0.3	

P/N: 74054-000CAS/000CASLF
ABOVE P.C.B

P/N: 74054-0**CAS/0**CASLF
ABOVE P.C.B

mat'l. code		surface	tolerance	projection	product family	
ISO 1302		ISO 406	ISO 1181			
tr ecn no dr date		tolerances unless otherwise specified			title	
v		angles	linear	± 0.30	MM	
		±2'			scale	
		dr WENDY CHEN	09/23/97		dwg no	
		enr STELAR CHU	09/23/97		74054	sheet 3 of 0
		chr JOSEPH HSIA	09/23/97			size
		app JENN TSAO	09/23/97			A4
sheet index		revision sheet		type CUSTOMER Drawing		

FCI CONFIDENTIAL



This document is the property of and embodies CONFIDENTIAL and PROPRIETARY information of FCI. No part of this information shown on this document may be used in any way or disclosed to others without the written consent of FCI.
Copyright FCI.

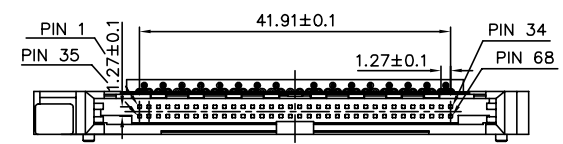
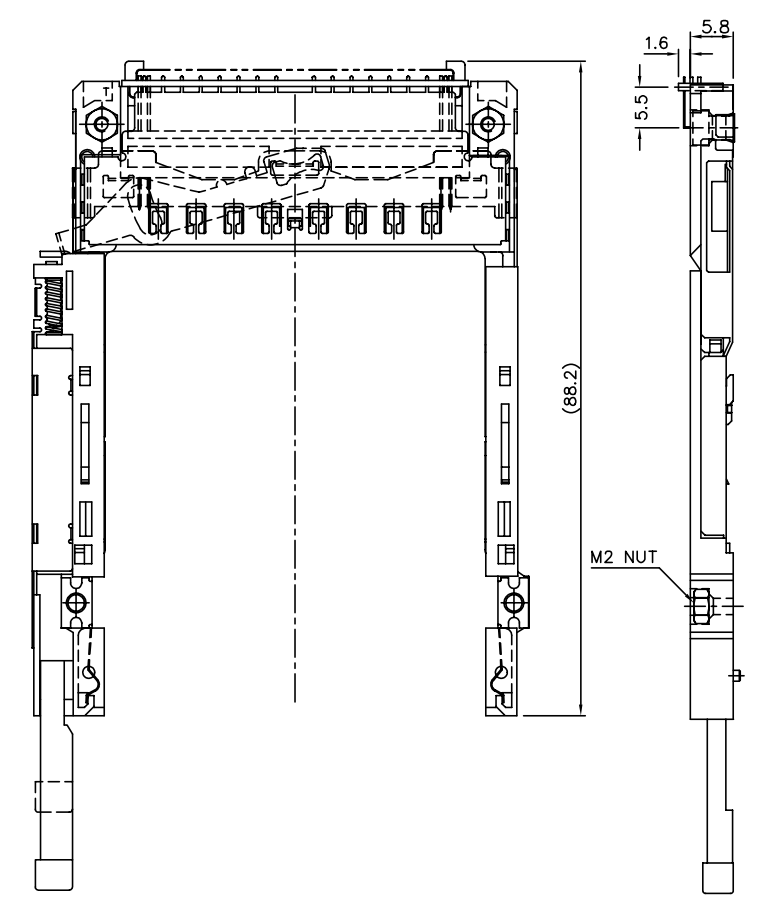
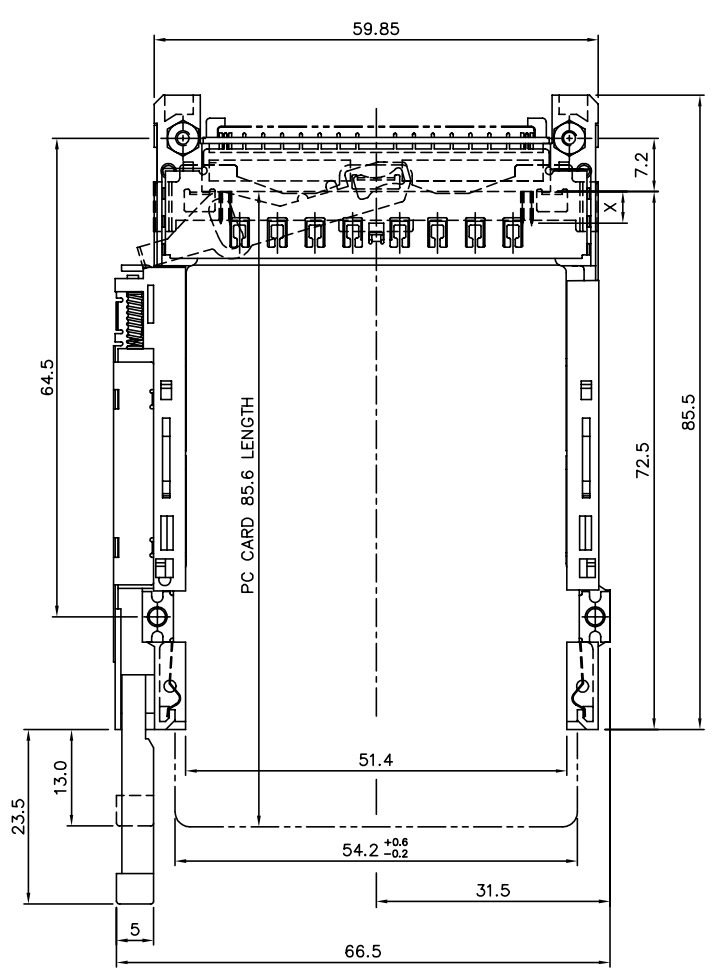
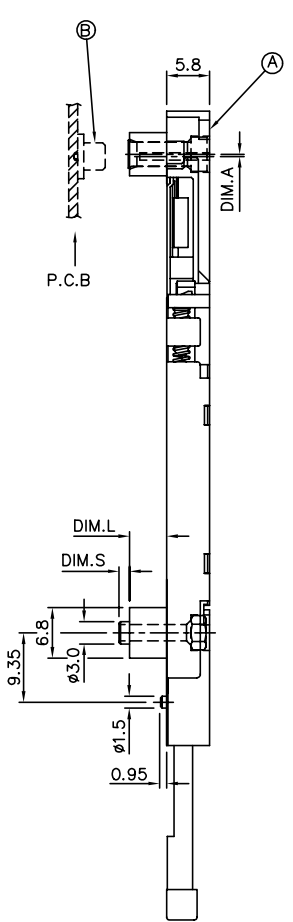

P/N: 74054-100CAS/100CASLF
ABOVE P.C.B

P/N	DIM.L	DIM.A	DIM.S
74054-120CAS/120CASLF	2.0	1.0	1.4 MAX.
74054-122CAS/122CASLF	2.2	1.0	1.0 MAX.
74054-128CAS/128CASLF	2.8	1.0	1.4 MAX.
74054-140CAS/140CASLF	4.0	0.3	1.0 MAX.
74054-143CAS/143CASLF	4.3	0.3	1.4 MAX.
74054-150CAS/150CASLF	5.0	0.3	1.4 MAX.

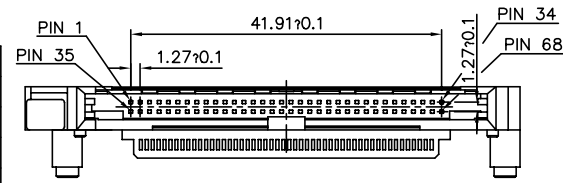

P/N: 74054-1**CAS/1**CASLF
ABOVE P.C.B

mat'l. code		surface ISO 1302		tolerance ISO 406 ISO 1181		projection 1:1		product family	
tr/ecn no/dr		date		tolerances unless otherwise specified		title		CARDBUS SINGLE DECK 2-STEP, TYPE 1/2/3	
v		angles		linear ± 0.30		MM		dwg no 74054 sheet 4 of 0 size A4	
		±2'				scale		type CUSTOMER Drawing	
		dr WENDY CHEN 09/23/97		engr STELAR CHU 09/23/97		chr JOSEPH HSIA 09/23/97		app JENN TSAO 09/23/97	
sheet index		revision sheet							



FCI CONFIDENTIAL



This document is the property of and embodies CONFIDENTIAL and PROPRIETARY information of FCI. No part of this information shown on this document may be used in any way or disclosed to others without the written consent of FCI.
Copyright FCI.

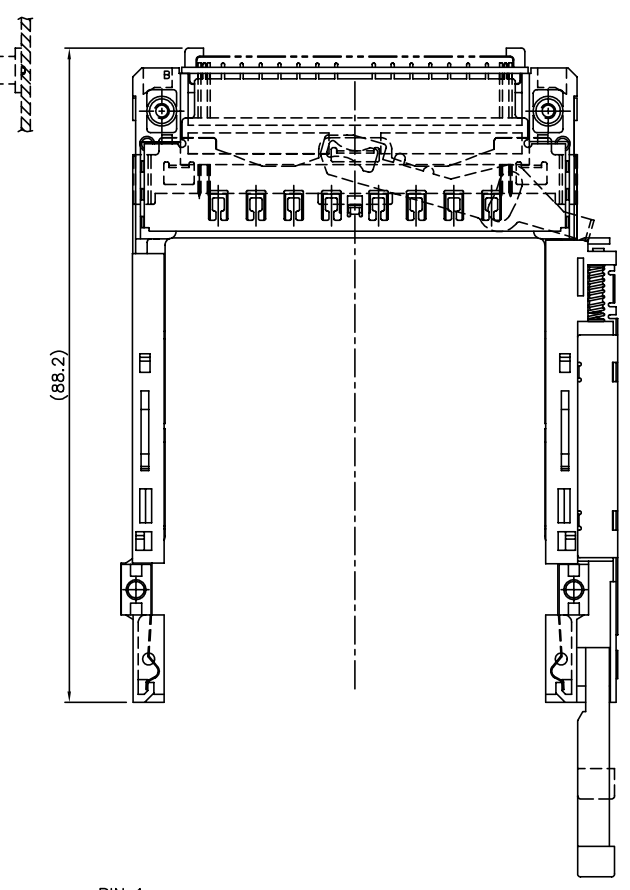
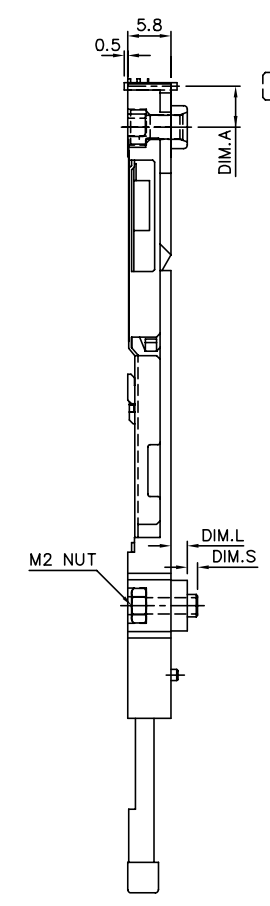
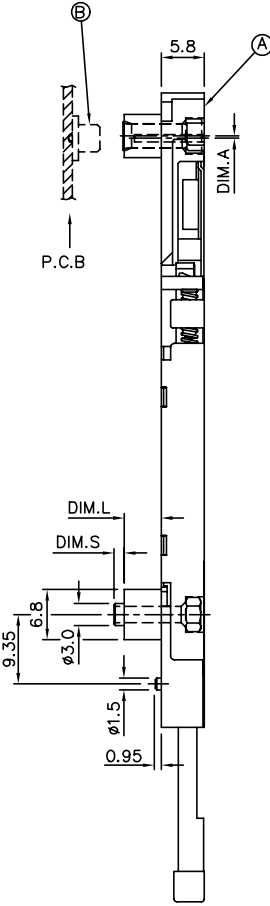
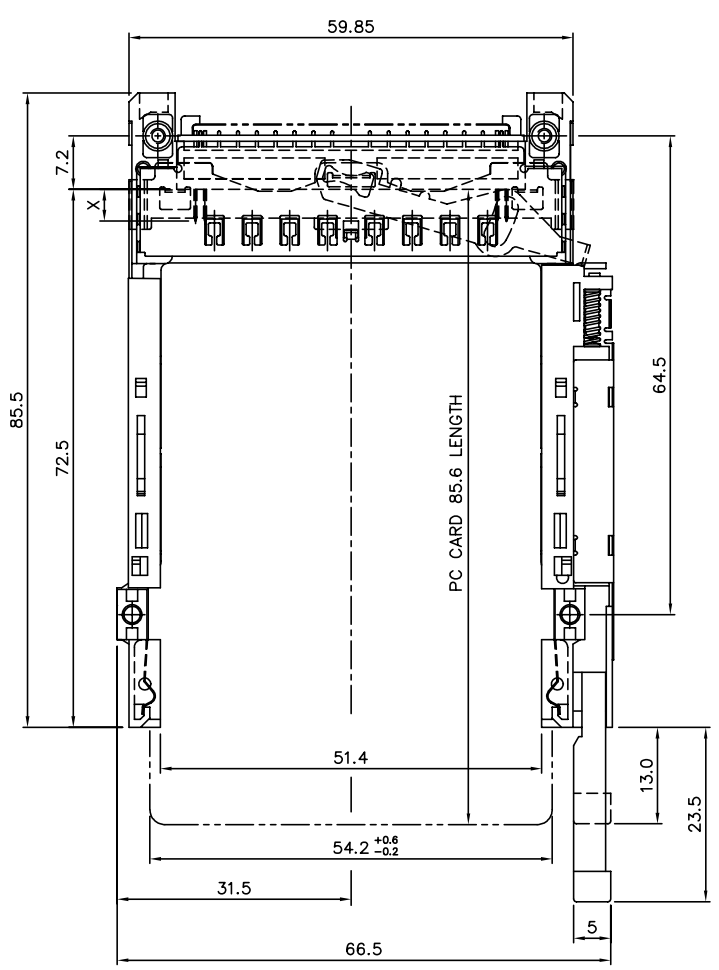

74054-522CAS/522CASLF
BELOW BOARD

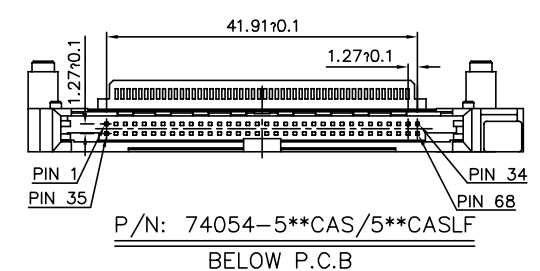

P/N	DIM.L	DIM.A	DIM.S
74054-522CAS/522CASLF	2.2	5.5	1.4 MAX.
74054-540CAS/540CASLF	4.0	0.3	1.0 MAX.
74054-543CAS/543CASLF	4.3	0.3	1.4 MAX.
74054-550CAS/550CASLF	5.0	0.3	

mat'l. code		surface	tolerance	projection	product family
		ISO 1302	ISO 406	ISO 1181	
tr	ec	no	dr	date	tolerances unless otherwise specified
v					title
			angles	linear	± 0.30
			±2'	scale	MM
		dr	WENDY CHEN	09/23/97	CARDBUS SINGLE DECK 2-STEP, TYPE 1/2/3
		engr	STELAR CHU	09/23/97	
		chr	JOSEPH HSIA	09/23/97	
		app	JENN TSAO	09/23/97	
		dwg no	74054	sheet 5 of 0	size
		type	CUSTOMER		A4
sheet index	revision sheet	Drawing			

FCI CONFIDENTIAL



This document is the property of and embodies CONFIDENTIAL and PROPRIETARY information of FCI. No part of this information shown on this document may be used in any way or disclosed to others without the written consent of FCI.
Copyright FCI.

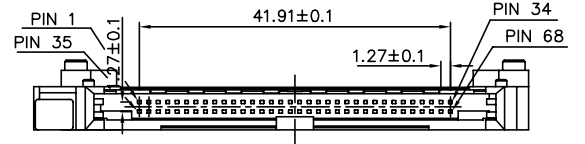
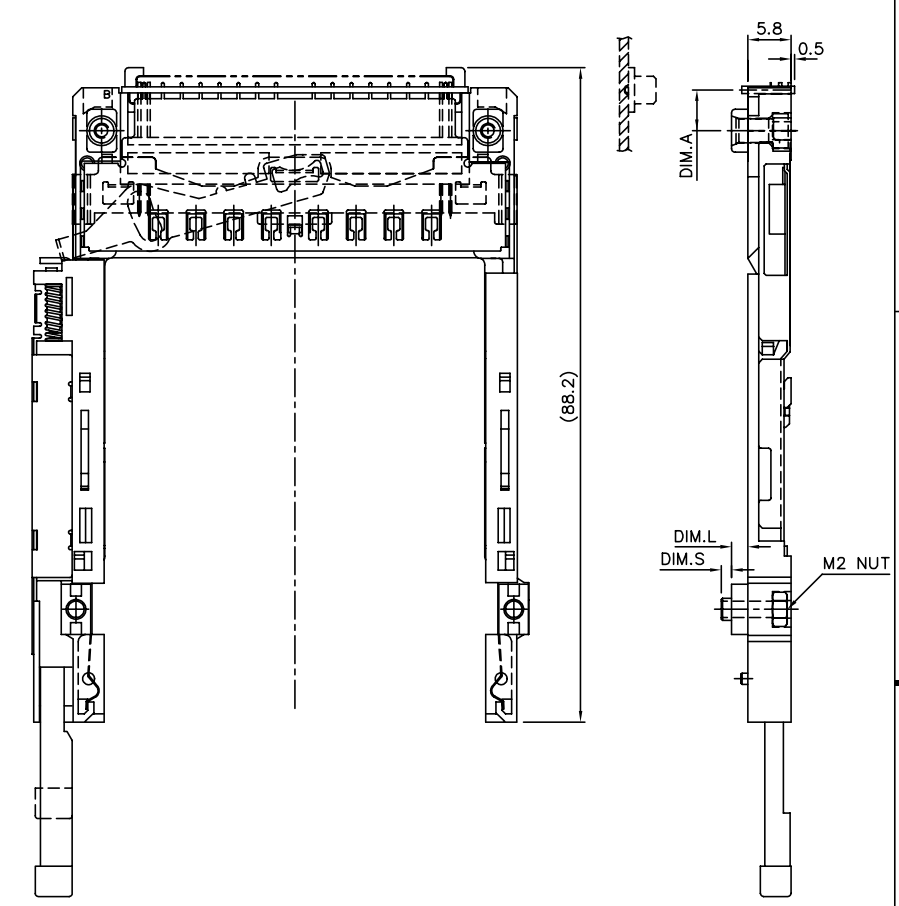
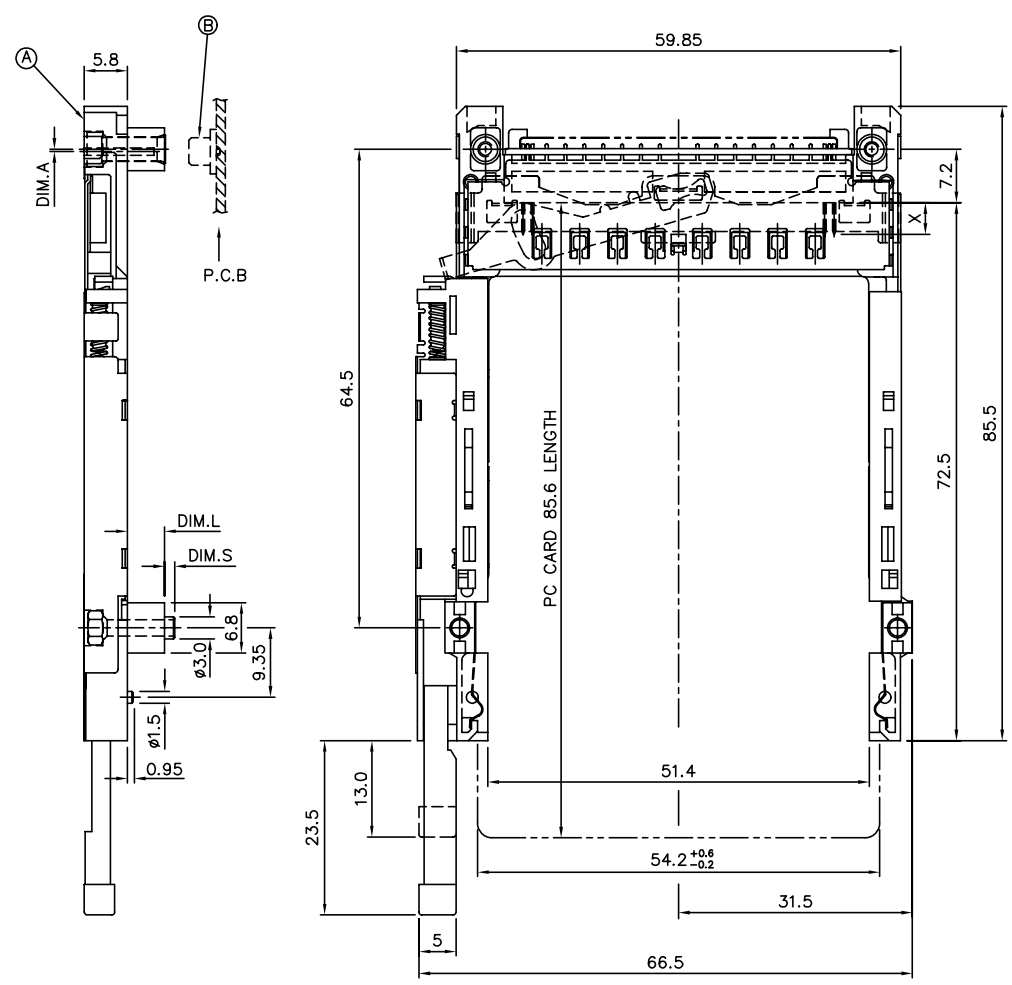

74054-622CAS/622CASLF
BELOW BOARD

P/N	DIM.L	DIM.A	DIM.S
74054-622CAS/622CASLF	2.2	5.5	1.4 MAX.
74054-640CAS/640CASLF	4.0	0.3	1.0 MAX.
74054-643CAS/643CASLF	4.3	0.3	1.4 MAX.
74054-650CAS/650CASLF	5.0	0.3	

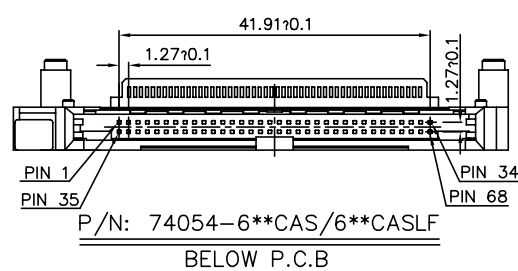

mat'l. code	surface	tolerance	projection	product family
	ISO 1302	ISO 406 ISO 1181		CARDBUS SINGLE DECK
tr/ecn no/dr	date	tolerances unless otherwise specified	title	2-STEP, TYPE 1/2/3
v		angles	linear	MM
		±2'	± 0.30	scale
	dr WENDY CHEN	09/23/97		dwg no
	engr STELAR CHU	09/23/97		74054
	chr JOSEPH HSIA	09/23/97		sheet 6 of 0
	app JENN TSAO	09/23/97		size A4
sheet index	revision sheet			type CUSTOMER Drawing

FCI CONFIDENTIAL

FCI
FCIconnect.com

This document is the property of and embodies CONFIDENTIAL and PROPRIETARY information of FCI. No part of the information shown on this document may be used in any way or disclosed to others without the written consent of FCI.
Copyright FCI.

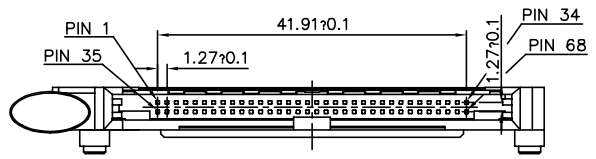
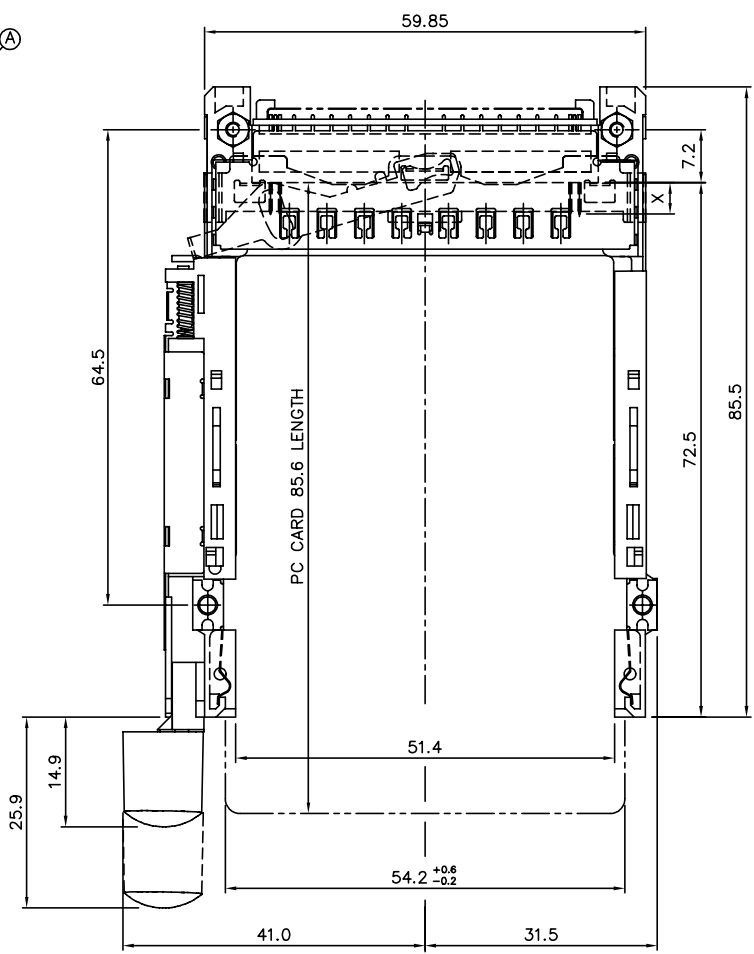
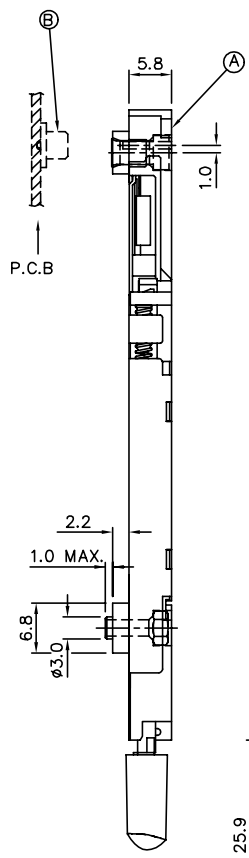

P/N: 74054-122CAT/122CATLF
ABOVE P.C.B

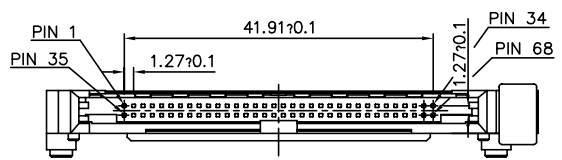
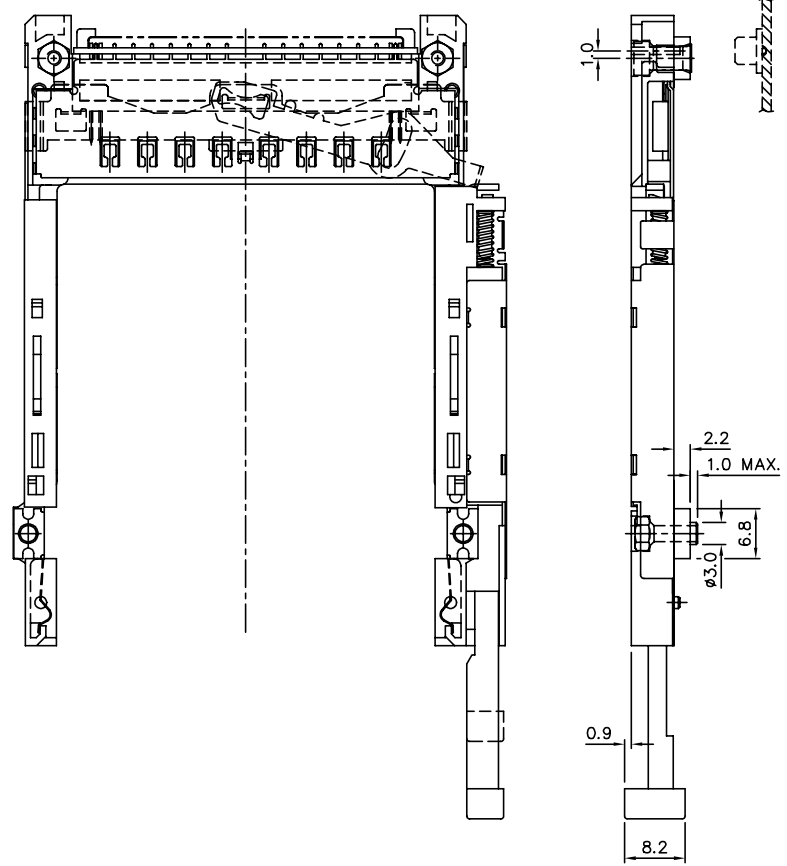

P/N: 74054-022CAR /022CARLF
ABOVE P.C.B

mat'l. code	surface	tolerance	projection	product family
	ISD 1302	ISD 406 ISD 110		
ltr ecn no dr date	tolerances unless otherwise specified			title
V	angles	linear	± 0.30	CARBUS SINGLE DECK 2-STEP, TYPE 1/2/3
	±2'		MM	
	dr	WENDY CHEN	09/23/97	dwg no
	eng	STELAR CHU	09/23/97	74054
	chr	JOSEPH HSIA	09/23/97	sheet 7 of 0
	app	JENN TSAO	09/23/97	size A4
sheet index	revision sheet			type CUSTOMER Drawing

PART NUMBER
 74054-322CAS
 74054-322CASLF

FCI CONFIDENTIAL

This document is the property of and embodies CONFIDENTIAL and PROPRIETARY information of FCI. No part of this information shown on this document may be used in any way or disclosed to others without the written consent of FCI.
 Copyright FCI.

FCI
 FCIconnect.com

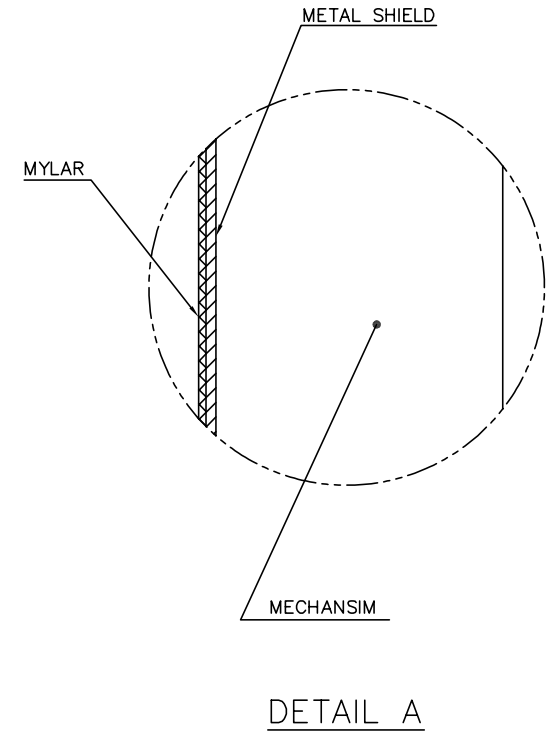
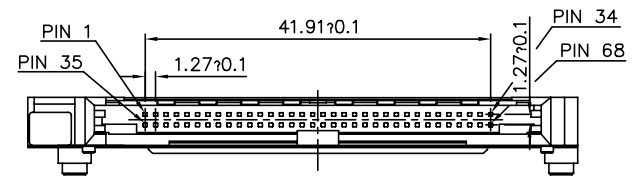
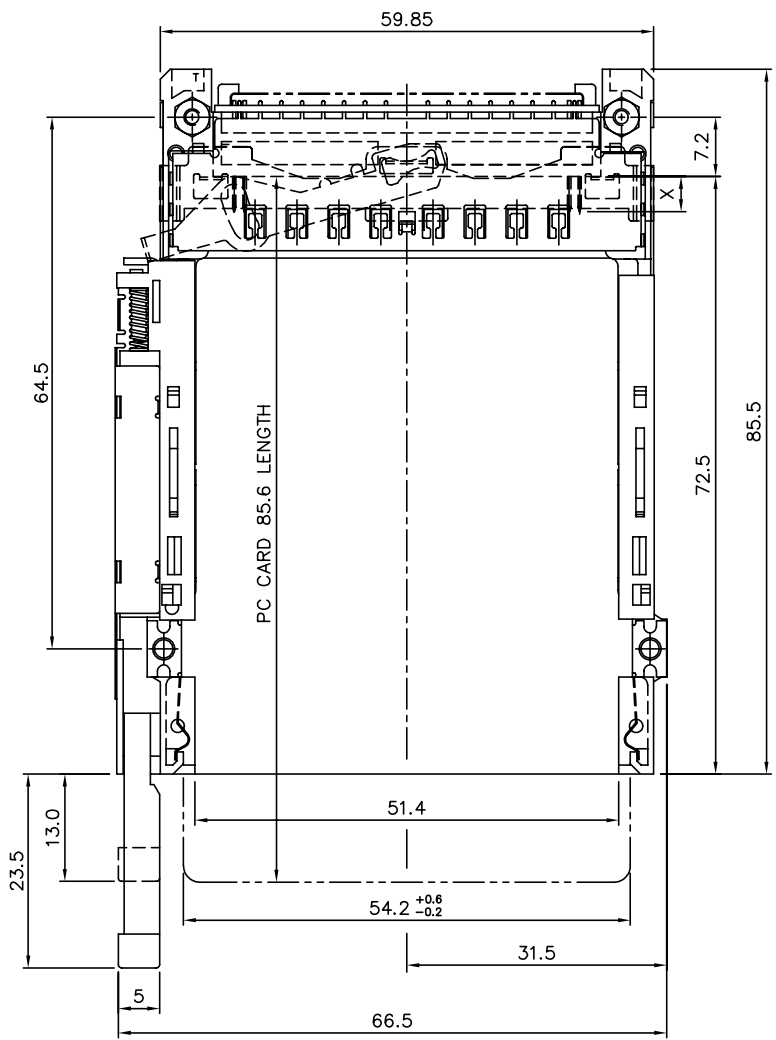
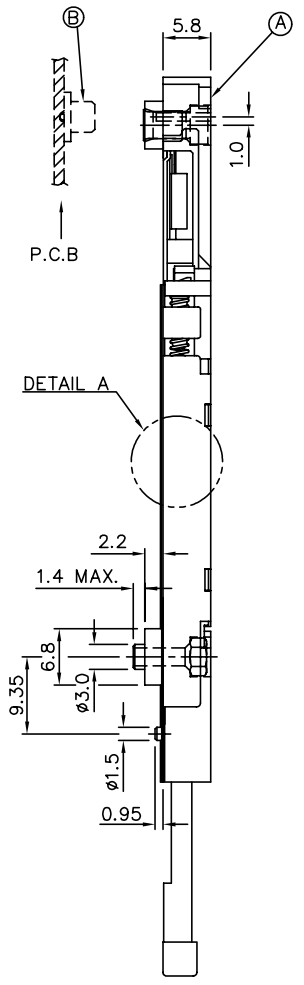

mat'l. code	surface ISO 1302	tolerance ISO 406 ISO 1101	projection 1:1	product family
trn ecn no dr date	tolerances unless otherwise specified			title
v	angles ±2'	linear ± 0.30	MM	CARBUS SINGLE DECK 2-STEP, TYPE 1/2/3
	dr WENDY CHEN 09/23/97	engr STELAR CHU 09/23/97	chr JOSEPH HSIA 09/23/97	app JENN TSAO 09/23/97
sheet index	revision sheet	FCI		dwg no 74054 sheet 8 of 10 size A4
				type CUSTOMER Drawing

FCI CONFIDENTIAL



This document is the property of and embodies CONFIDENTIAL and PROPRIETARY information of FCI. No part of this information shown on this document may be used in any way or disclosed to others without the written consent of FCI.
Copyright FCI.

PART NUMBER	PUSH ROD COLOR
74054-740CAS-B	BLACK

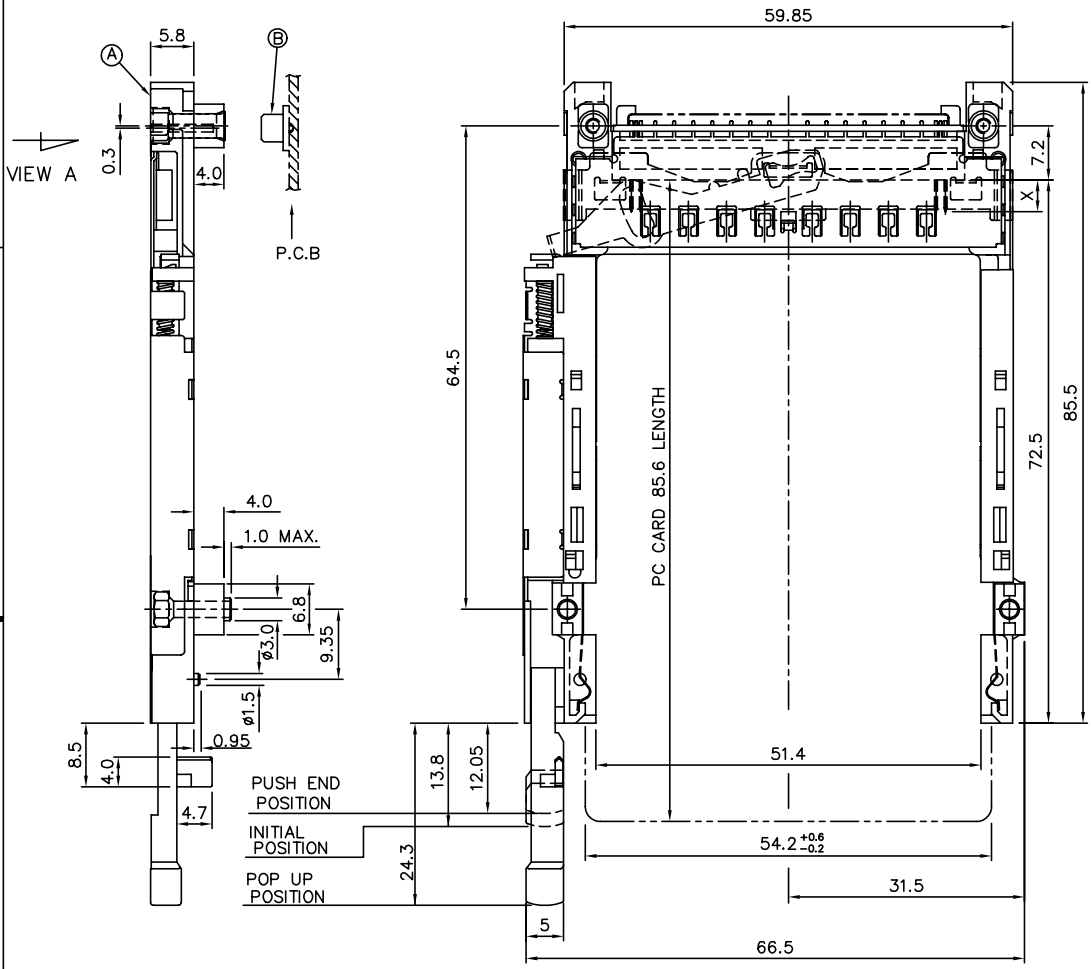

VIEW A
(FOR 74054-740CAS-B/840CAS ONLY)

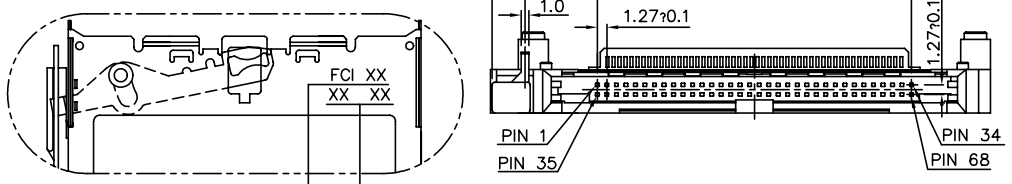

XX XX : MONTH / DAY
(MANUFACTURE DATE)
XX: YEAR

PART NUMBER	PUSH ROD COLOR
74054-840CAS	BLACK

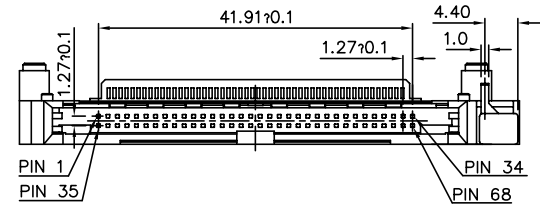
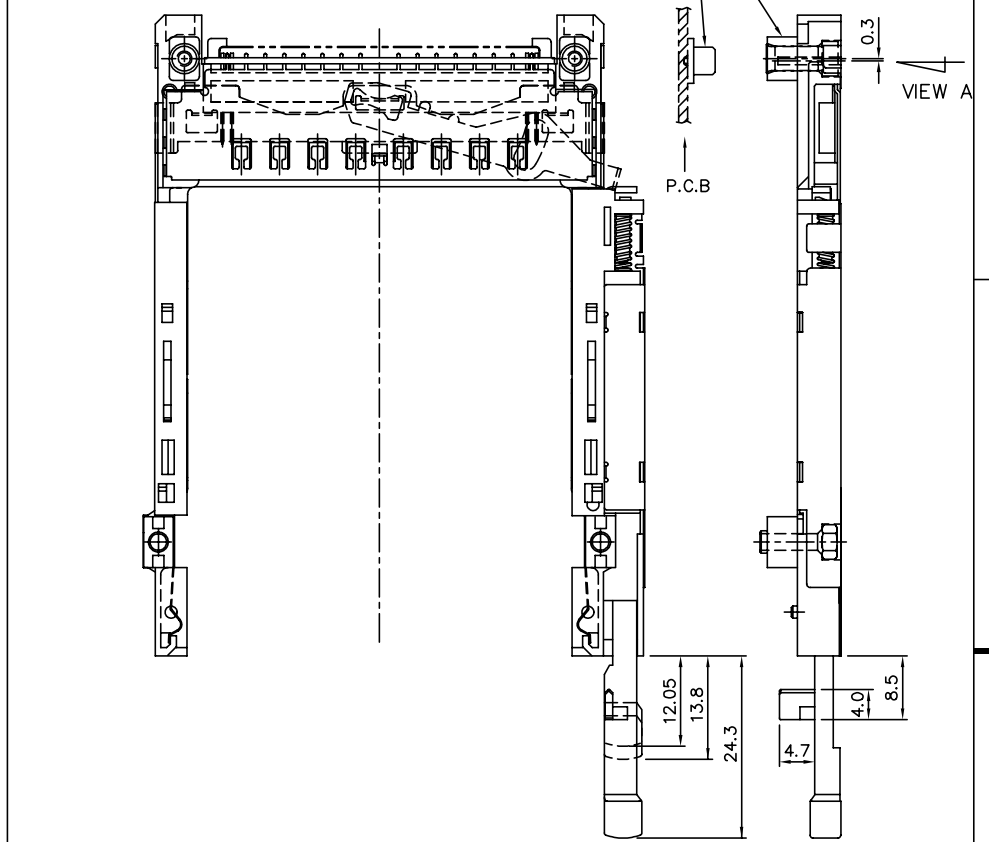

mat'l. code	surface	tolerance	projection	product family	
	ISO 1302	ISO 406 ISO 1181	1:1	CARBUS SINGLE DECK	
trn ecn no dr date	tolerances unless otherwise specified				
v	angles	linear	± 0.30	MM	
	±2'			scale	
	dr WENDY CHEN	09/23/97	FCI	dwg no	
	engr STELAR CHU	09/23/97		74054	sheet 9 of 0
	chr JOSEPH HSIA	09/23/97			size
	app JENN TSAO	09/23/97			A4
sheet index	revision sheet			type CUSTOMER	Drawing

FCI CONFIDENTIAL

FCI
FCIconnect.com
This document is the property of and embodies CONFIDENTIAL and PROPRIETARY information of FCI. No part of this information shown on this document may be used in any way or disclosed to others without the written consent of FCI.
Copyright FCI.

PART NUMBER	PUSH ROD COLOR
74054-740CAS-BLF	BLACK

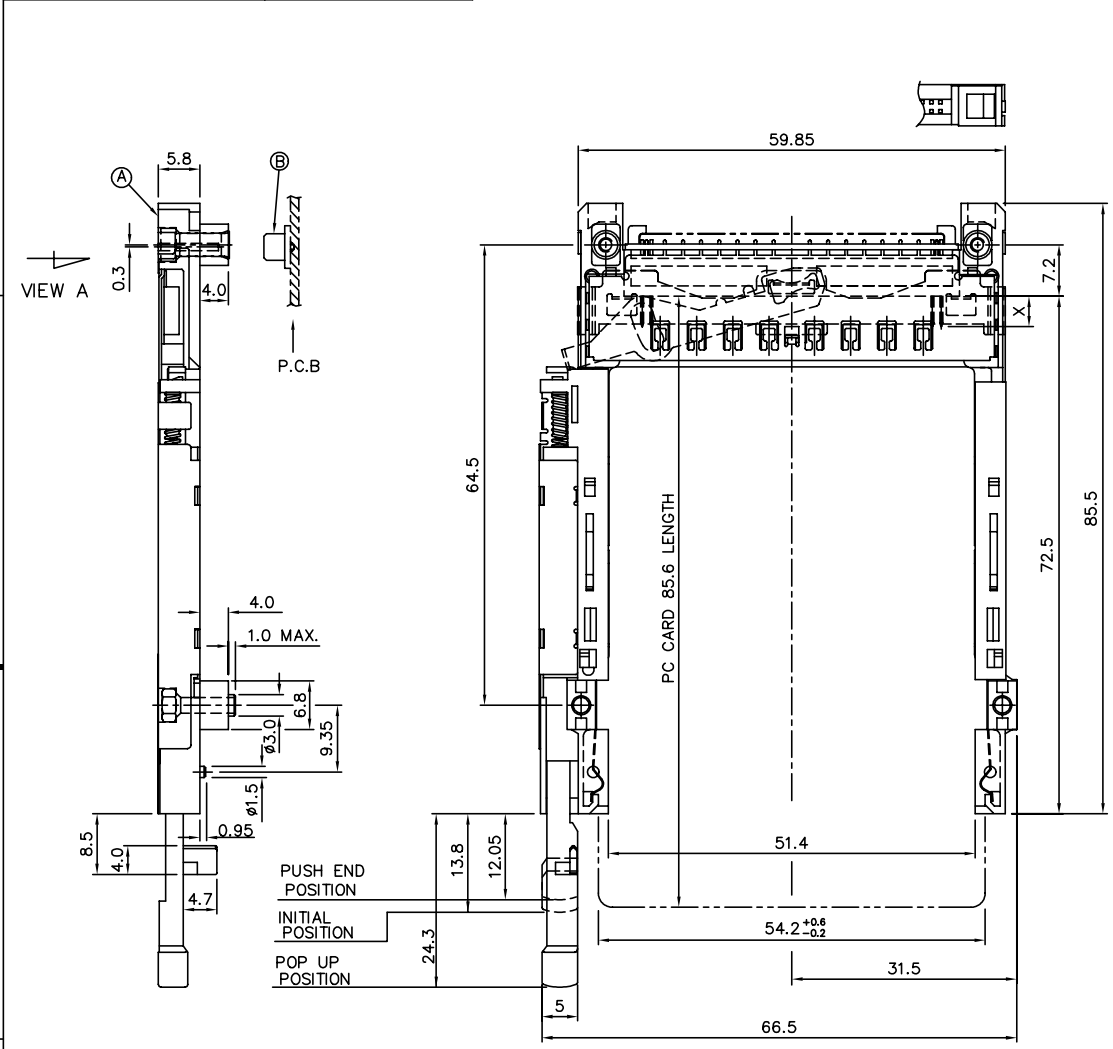

VIEW A
(FOR 74054-740CAS-BLF/840CASLF ONLY)

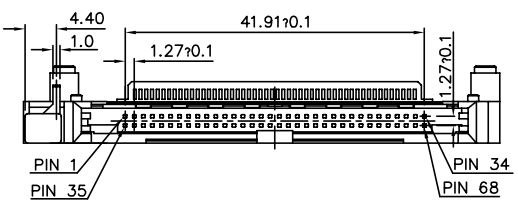
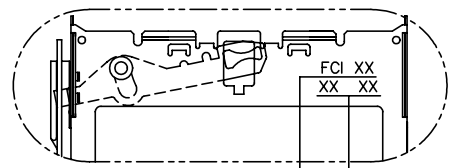

XX XX : MONTH / DAY
(MANUFACTURE DATE)
XX: YEAR

PART NUMBER	PUSH ROD COLOR
74054-840CASLF	BLACK

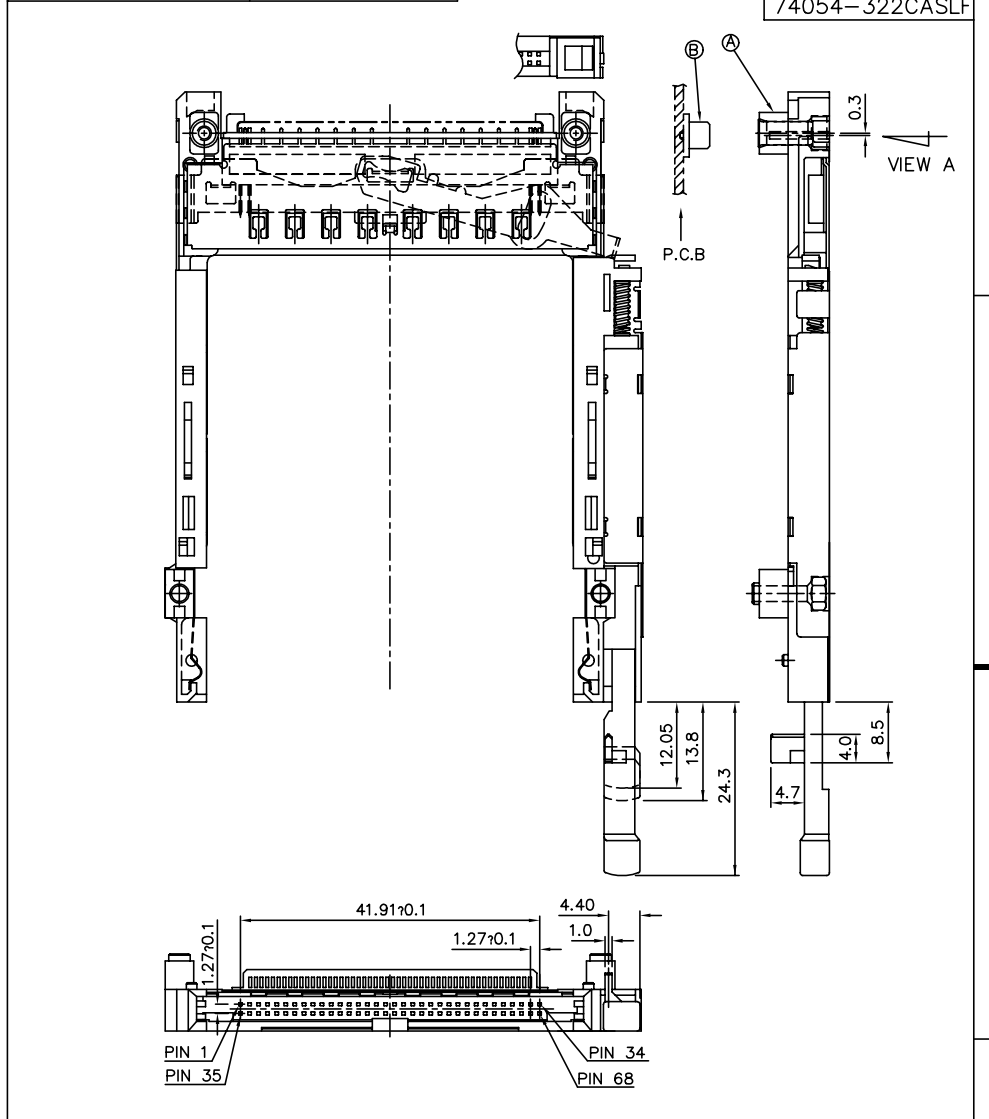

mat'l. code	surface	tolerance	projection	product family
	ISO 1302	ISO 406	ISO 1181	
tr ecn no dr date	tolerances unless otherwise specified			
v	angles	linear	MM	CARBUS SINGLE DECK 2-STEP, TYPE 1/2/3
	±2°	± 0.30	scale	dwg no 74054 sheet 0 of 0 size A4
	dr WENDY CHEN	09/23/97	FCI	type CUSTOMER Drawing
	engr STELAR CHU	09/23/97		
	chr JOSEPH HSIA	09/23/97		
	app JENN TSAO	09/23/97		
sheet index	revision sheet			