

# AUIPS2051L/AUIPS2052G

## INTELLIGENT POWER LOW SIDE SWITCH

### Features

- Over temperature shutdown
- Over current shutdown
- Active clamp
- Low current & logic level input
- ESD protection
- Optimized Turn On/Off for EMI
- Diagnostic on the input current

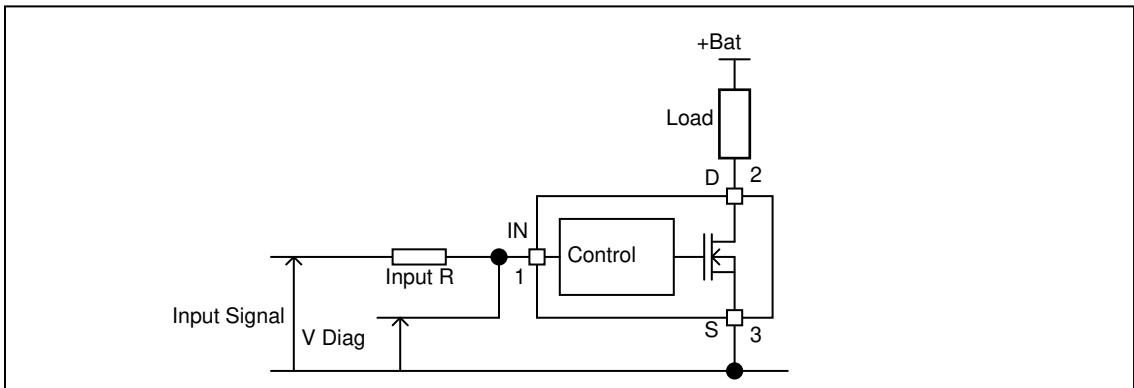
### Applications

- Solenoids and relays
- 24V truck loads

### Description

The AUIPS2051L/AUIPS2052G is a three terminal Intelligent Power Switch (IPS) that features a low side MOSFET with over-current, over-temperature, ESD protection and drain to source active clamp. The AUIPS2052 is a dual channel device while the AUIPS2051 is a single channel. This device offers protections and the high reliability required in harsh environments. The switch provides efficient protection by turning OFF the power MOSFET when the temperature exceeds 165°C or when the drain current reaches 1.8A. The device restarts once the input is cycled. A serial resistance connected to the input provides the diagnostic. The avalanche capability is significantly enhanced by the active clamp and covers most inductive load demagnetizations.

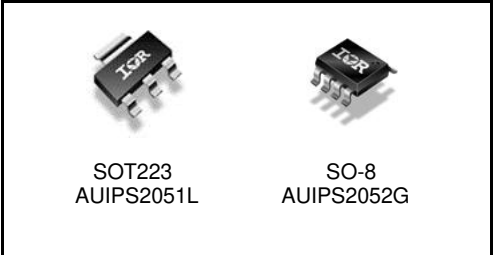
### Typical Connection



### Product Summary

Rds(on)	300mΩ (max.)
Vclamp	70V
Ishutdown	1.8A (typ.)

### Packages



## Qualification Information<sup>†</sup>

<b>Qualification Level</b>		Automotive (per AEC-Q100 <sup>††</sup> )	
		Comments: This IC has passed an Automotive qualification. IR's Industrial and Consumer qualification level is granted by extension of the higher Automotive level.	
<b>Moisture Sensitivity Level</b>		SOT-223	MSL2 <sup>††</sup> , 260°C (per IPC/JEDEC J-STD-020)
		8L-SOICN	MSL2 <sup>††</sup> , 260°C (per IPC/JEDEC J-STD-020)
<b>ESD</b>	Machine Model	Class M3 (per AEC-Q-100-003)	
	Human Body Model	Class H2 (per AEC-Q-100-002)	
	Charged Device Model	Class C5 (per AEC-Q-100-011)	
<b>IC Latch-Up Test</b>		ClassII, Level A (per AEC-Q100-004)	
<b>RoHS Compliant</b>		Yes	

† Qualification standards can be found at International Rectifier's web site <http://www.irf.com/>

†† Exceptions to AEC-Q100 requirements are noted in the qualification report.

## Absolute Maximum Ratings

Absolute maximum ratings indicate sustained limits beyond which damage to the device may occur. All voltage parameters are referenced to Ground lead. (Tambient=25°C unless otherwise specified).

Symbol	Parameter	Min.	Max.	Units
Vds	Maximum drain to source voltage	-0.3	60	V
Vds cont.	Maximum continuous drain to source voltage	-	35	V
Vin	Maximum input voltage	-0.3	6	V
Isd cont.	Max diode continuous current (limited by thermal dissipation) Rth=125°C/W	—	1	A
Pd	Maximum power dissipation (internally limited by thermal protection) Rth=60°C/W AUIPS2051L 1" sqr. footprint	—	2	W
	Rth=100°C/W AUIPS2052G std. footprint	—	1.25	
ESD	Electrostatic discharge voltage (Human body) C=100pF, R=1500Ω Between drain and source	—	4	kV
	Other combinations	—	3	
	Electrostatic discharge voltage (Machine Model) C=200pF,R=0Ω Between drain and source	—	0.5	
	Other combinations	—	0.3	
Tj max.	Max. storage & operating temperature junction temperature	-40	150	°C

## Thermal Characteristics

Symbol	Parameter	Typ.	Max.	Units
Rth1	Thermal resistance junction to ambient SOT-223 std. footprint	100	—	°C/W
Rth2	Thermal resistance junction to ambient SOT-223 1" sqr. footprint	60	—	
Rth1	Thermal resistance junction to ambient SO-8 std. Footprint	100	—	
	1 die active			
Rth1	Thermal resistance junction to ambient SO-8 std. footprint	130	—	
	2 die active			

note : Tj=Power dissipated in one channel x Rth

## Recommended Operating Conditions

These values are given for a quick design. For operation outside these conditions, please consult the application notes.

Symbol	Parameter	Min.	Max.	Units
VIH	High level input voltage	4	5.5	
VIL	Low level input voltage	0	0.5	
Ids	Continuous drain current, Tambient=85°C, Tj=125°C, Vin=5V,Rth=100°C/W	—	0.9	A
Rin	Recommended resistor in series with IN pin to generate a diagnostic	0.5	5	kΩ
Max. t rise	Max. input rising time	—	1	µs

## Static Electrical Characteristics

T<sub>J</sub>=-40..150°C, V<sub>CC</sub>=28V (unless otherwise specified)

Symbol	Parameter	Min.	Typ.	Max.	Units	Test Conditions
R <sub>ds(on)</sub>	ON state resistance T <sub>J</sub> =25°C	—	250	300	mΩ	V <sub>in</sub> =5V, I <sub>ds</sub> =1A
	ON state resistance T <sub>J</sub> =150°C(2)	—	440	520		
I <sub>dss1</sub>	Drain to source leakage current	—	0.2	1	μA	V <sub>CC</sub> =28V, T <sub>J</sub> =25°C
I <sub>dss2</sub>	Drain to source leakage current	—	0.5	2		V <sub>CC</sub> =50V, T <sub>J</sub> =25°C
V <sub>clamp1</sub>	Drain to source clamp voltage 1	63	69	—	V	I <sub>d</sub> =20mA See fig. 3 & 4
V <sub>clamp2</sub>	Drain to source clamp voltage 2	—	70	75		
V <sub>in clamp</sub>	IN to source pin clamp voltage	5.5	6.2	7.5		
V <sub>th</sub>	Input threshold voltage	1.1	2	2.7		
I <sub>in, on</sub>	ON state IN positive current	15	40	80	μA	V <sub>in</sub> =5V
I <sub>in, off</sub>	OFF state IN positive current ( after protection latched )	150	250	350		

## Switching Electrical Characteristics

V<sub>CC</sub>=28V, Resistive load=50Ω, R<sub>input</sub>=50Ω, V<sub>in</sub>=5V, T<sub>J</sub>=25°C

Symbol	Parameter	Min.	Typ.	Max.	Units	Test Conditions
T <sub>d(on)</sub>	Turn-on delay time to 20%	0.1	1	3	μs	See figure 2
T <sub>r</sub>	Rise time 20% to 80%	0.1	0.3	2.5		
T <sub>d(off)</sub>	Turn-off delay time to 80%	1	1.8	3.5		
T <sub>f</sub>	Fall time 80% to 20%	0.1	0.5	2.5		
E <sub>on</sub> + E <sub>off</sub>	Turn on and off energy	—	5	—	μJ	

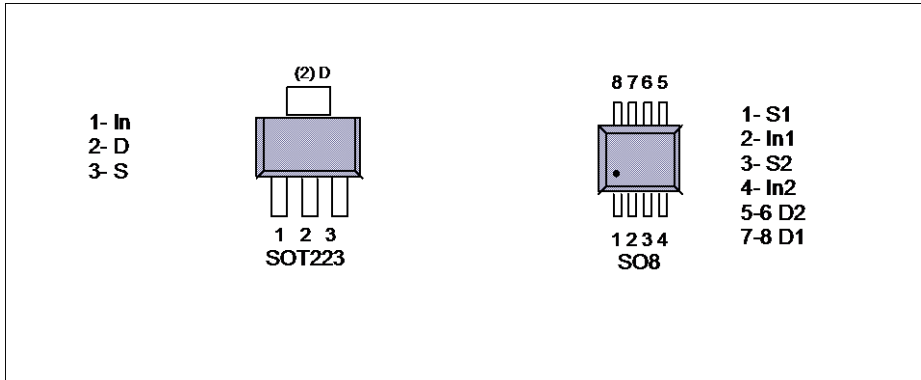
## Protection Characteristics

T<sub>J</sub>=-40..150°C, V<sub>CC</sub>=28V (unless otherwise specified)

Symbol	Parameter	Min.	Typ.	Max.	Units	Test Conditions
T <sub>sd</sub>	Over temperature threshold	150(2)	165	—	°C	See figure 1
I <sub>sd</sub>	Over current threshold	1.2	1.8	3	A	See figure 1
V <sub>reset</sub>	IN protection reset threshold	1.1	1.6	2	V	
T <sub>reset</sub>	Time to reset protection	15(2)	50	500	μs	V <sub>in</sub> =0V, T <sub>J</sub> =25°C

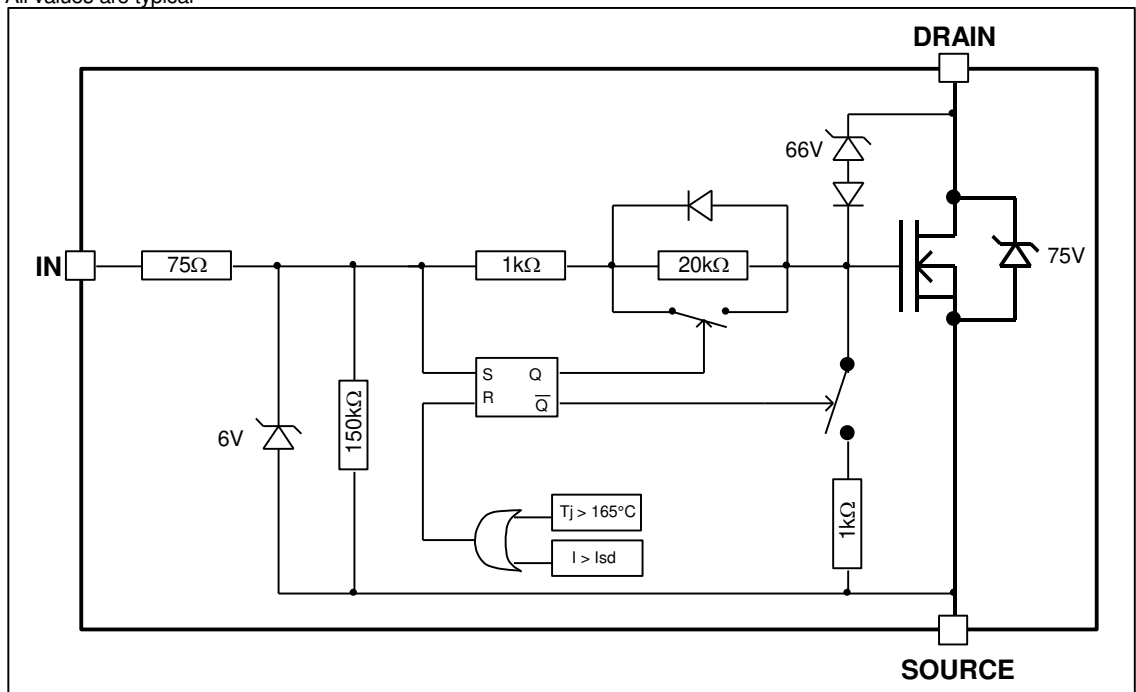
(2) Guaranteed by design

## Lead Assignments



## Functional Block Diagram

All values are typical



All curves are typical values. Operating in the shaded area is not recommended.

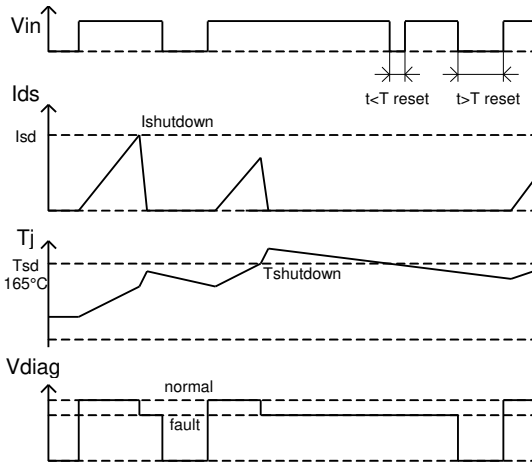


Figure 1 – Timing diagram

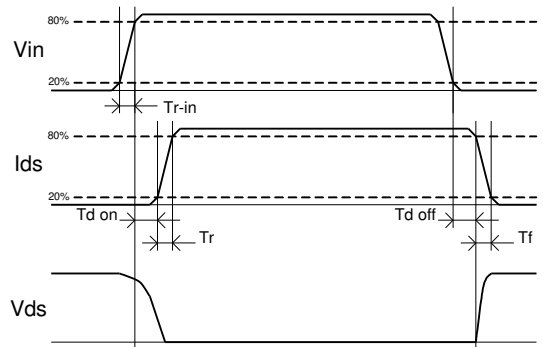


Figure 2 – IN rise time & switching definitions

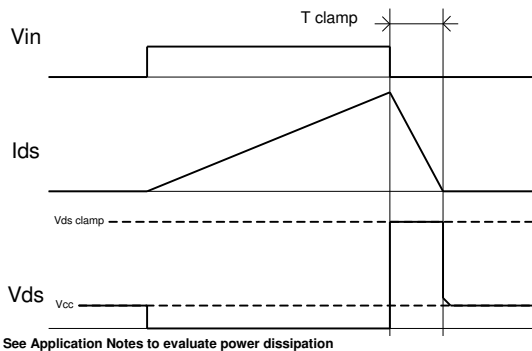


Figure 3 – Active clamp waveforms

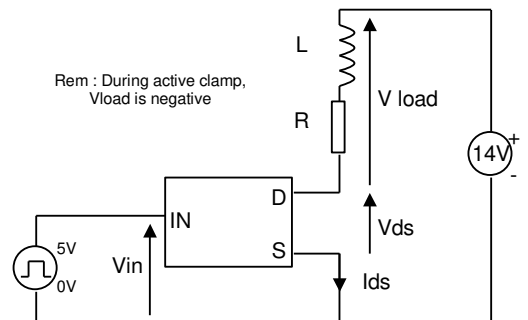
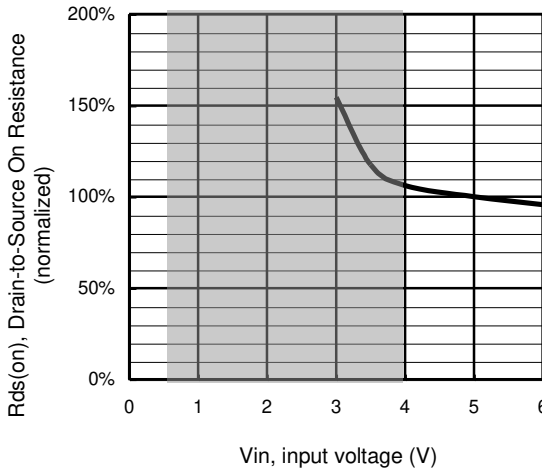
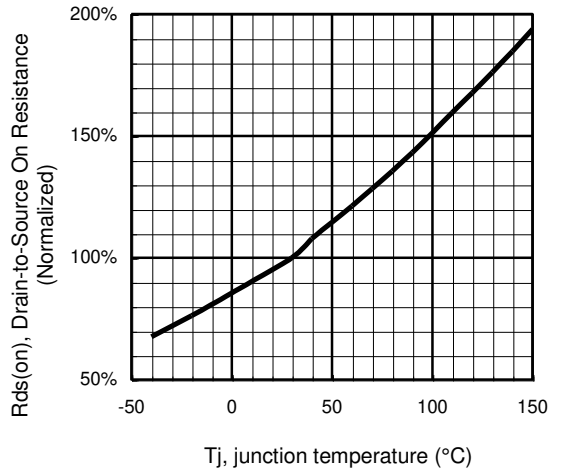


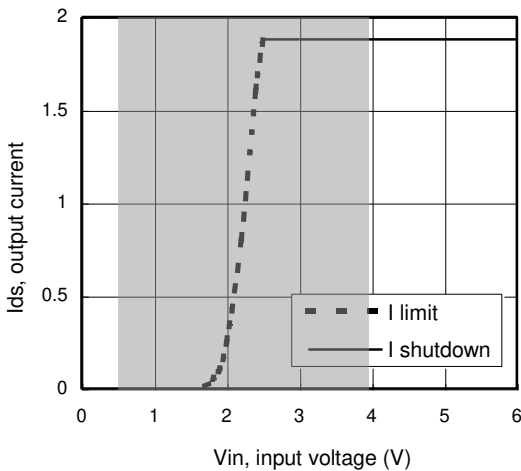
Figure 4 – Active clamp test circuit



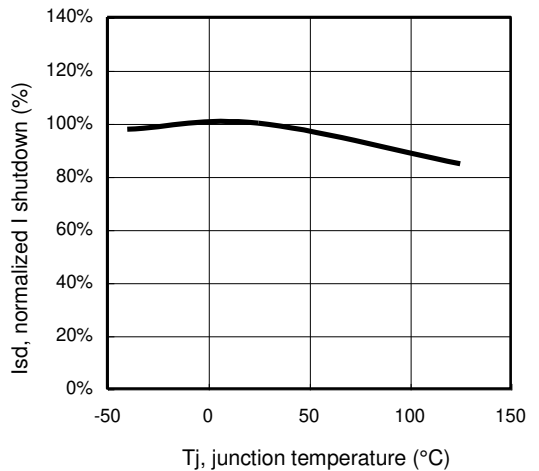
**Figure 5 – Normalized Rds(on) (%) Vs Input voltage (V)**



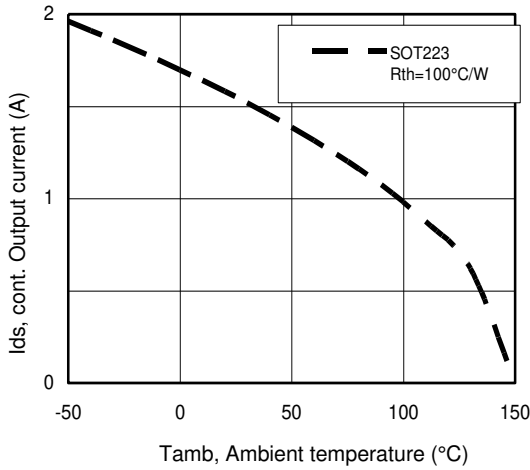
**Figure 6 - Normalized Rds(on) (%) Vs Tj (°C)**



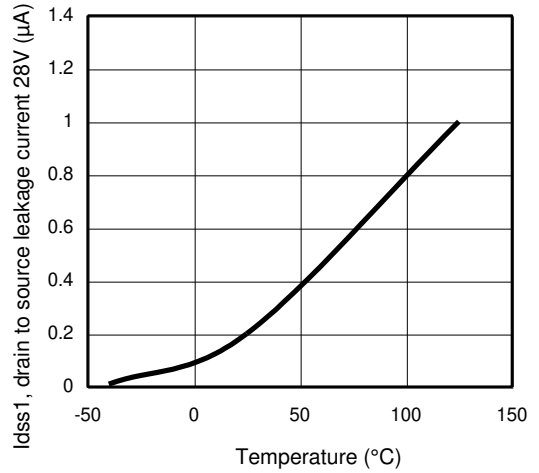
**Figure 7 – Current limitation and current shutdown Vs Input voltage (V)**



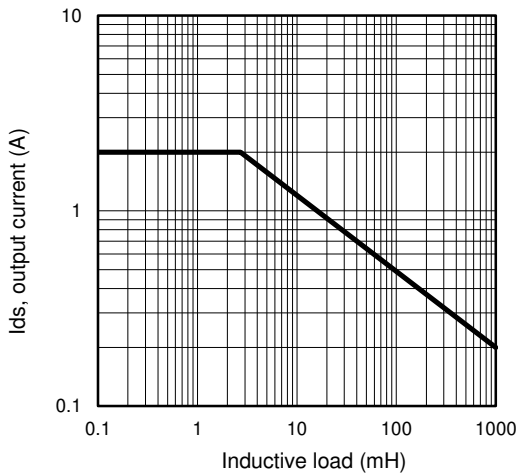
**Figure 8 – Normalized I shutdown (%) Vs junction temperature (°C)**



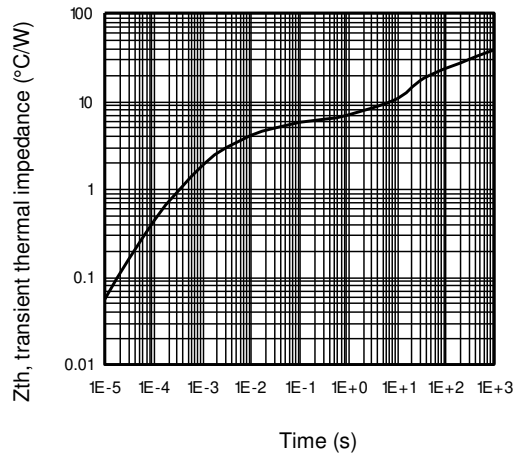
**Figure 9 – Max. continuous output current (A) Vs Ambient temperature (°C)**



**Figure 10 – Idss1 (µA) Vs temperature (°C)**



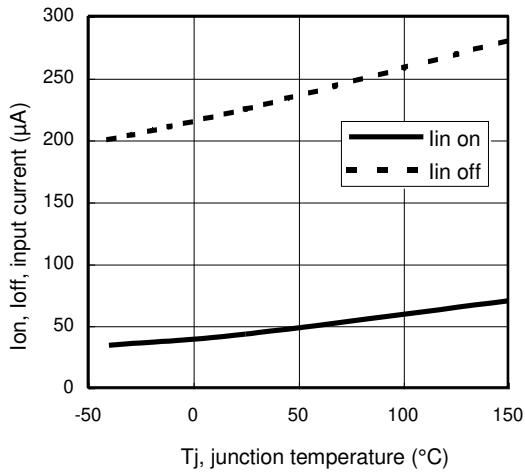
**Figure 11 – Max. output current (A) Vs Inductive load (mH)**



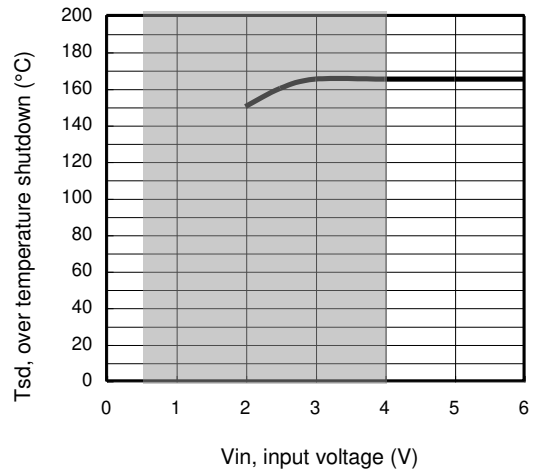
**Figure 12 – Transient thermal impedance (°C/W) Vs time (s)**

This is for single pulse when  $T_j=165^\circ\text{C}$  and for repetitive pulses when  $T_j<115^\circ\text{C}$  before turning off.



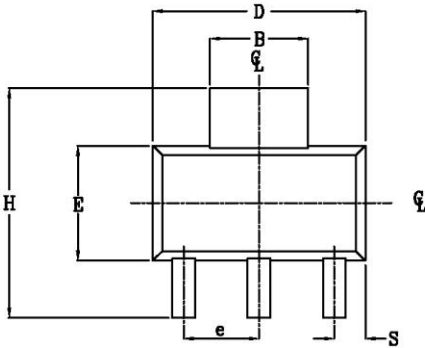


**Figure 13 – Input current ( $\mu\text{A}$ ) On and Off Vs junction temperature ( $^{\circ}\text{C}$ )**



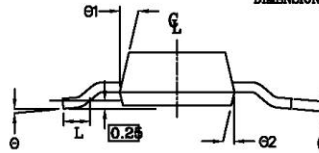
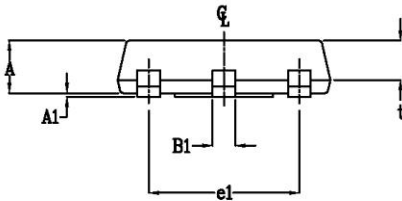
**Figure 14 – Over temperature shutdown ( $^{\circ}\text{C}$ ) Vs input voltage (V)**

Case Outline - SOT-223



POS	MILLIMETERS		INCHES	
	MAX	MIN	MAX	MIN
A	1.70	1.50	.067	.060
AI	0.10	0.02	.004	.0008
B	3.15	2.95	.124	.116
BI	0.85	0.85	.033	.028
C	0.35	0.25	.014	.010
D	6.70	6.30	.264	.248
e	2.30 NOM		.0905 NOM	
e1	4.60 NOM		.181 NOM	
E	3.70	3.30	.146	.130
H	7.30	6.70	.287	.264
S	1.05	0.85	.041	.033
t	1.30	1.10	.051	.043
∅	10° MAX		10° MAX	
∅1	16°	10°	16°	10°
∅2	16°	10°	16°	10°
L	0.75 MIN		0.0295 MIN	

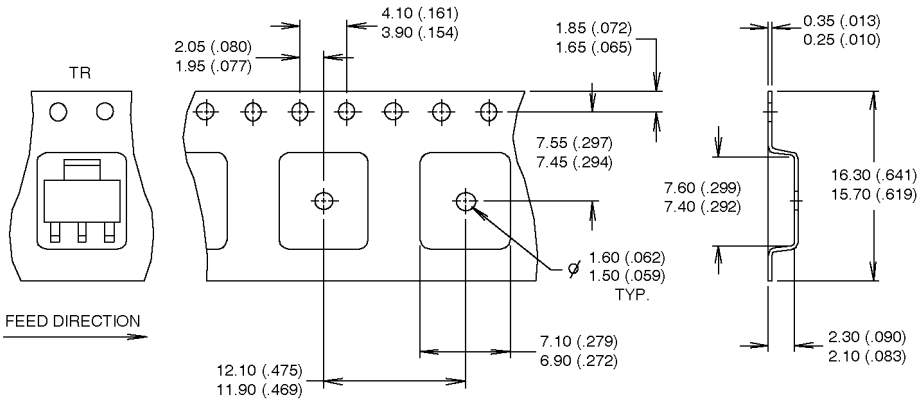
NOTE:  
 1. PACKAGE OUTLINE EXCLUSIVE OF ANY MOLD FLASHES DIMENSION.  
 2. PACKAGE OUTLINE EXCLUSIVE OF BURR DIMENSION.



Leads and drain are plated with 100% Sn

## Tape & Reel - SOT-223

Dimensions are shown in millimeters (inches)



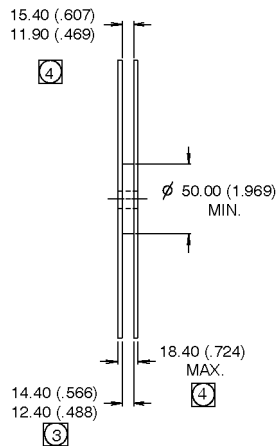
**NOTES:**

1. CONTROLLING DIMENSION: MILLIMETER.
2. OUTLINE CONFORMS TO EIA-481 & EIA-541.
3. EACH  $\varnothing 330.00$  (13.00) REEL CONTAINS 2,500 DEVICES.



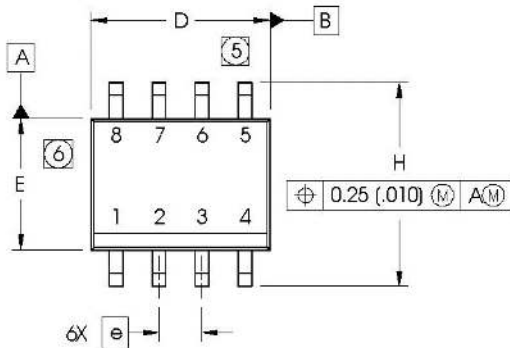
**NOTES:**

1. OUTLINE CONFORMS TO EIA-418-1.
2. CONTROLLING DIMENSION: MILLIMETER.
- ④ DIMENSION MEASURED @ HUB.
- ③ INCLUDES FLANGE DISTORTION @ OUTER EDGE.

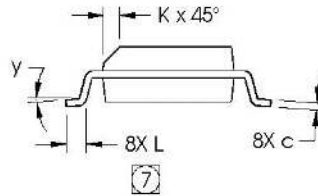
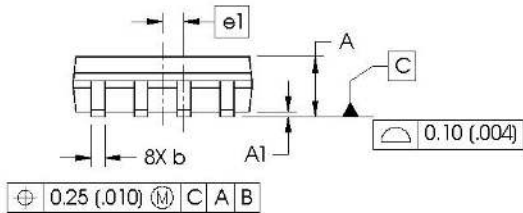


## Case Outline - SO-8

Dimensions are shown in millimeters (inches)

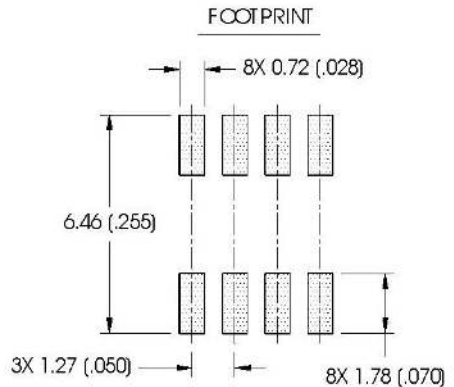


DIM	INCHES		MILLIMETERS	
	MIN	MAX	MIN	MAX
A	.0532	.0688	1.35	1.75
A1	.0040	.0098	0.10	0.25
b	.013	.020	0.33	0.51
c	.0075	.0098	0.19	0.25
D	.189	.1968	4.80	5.00
E	.1497	.1574	3.80	4.00
e	.050 BASIC		1.27 BASIC	
e1	.025 BASIC		0.635 BASIC	
H	.2284	.2440	5.80	6.20
K	.0099	.0196	0.25	0.50
L	.016	.050	0.40	1.27
y	0°	8°	0°	8°



**NOTES:**

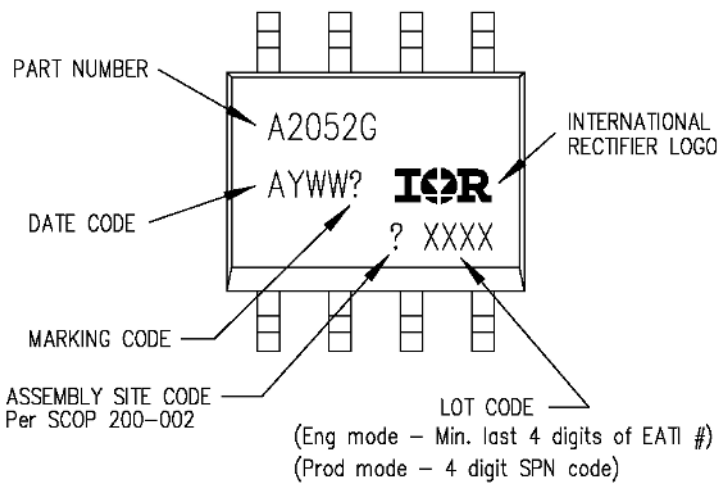
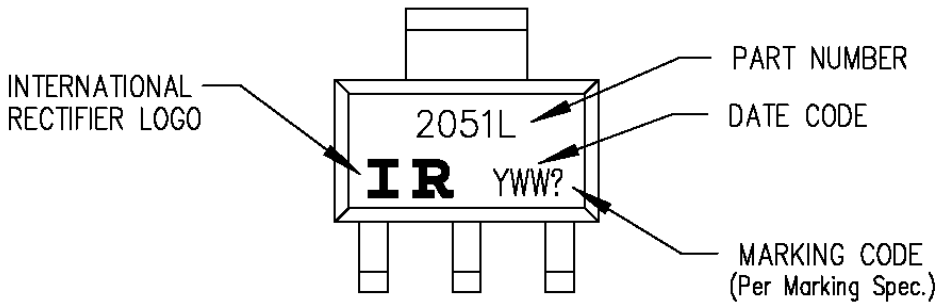
1. DIMENSIONING & TOLERANCING PER ASME Y14.5M-1994.
2. CONTROLLING DIMENSION: MILLIMETER
3. DIMENSIONS ARE SHOWN IN MILLIMETERS (INCHES).
4. OUTLINE CONFORMS TO JEDEC OUTLINE MS-012AA.
5. DIMENSION DOES NOT INCLUDE MOLD PROTRUSIONS. MOLD PROTRUSIONS NOT TO EXCEED 0.15 (.006).
6. DIMENSION DOES NOT INCLUDE MOLD PROTRUSIONS. MOLD PROTRUSIONS NOT TO EXCEED 0.25 (.010).
7. DIMENSION IS THE LENGTH OF LEAD FOR SOLDERING TO A SUBSTRATE.



Leads and drain are plated with 100% Sn



## Part Marking Information



## Ordering Information

Base Part Number	Package Type	Standard Pack		Complete Part Number
		Form	Quantity	
AUIPS2051L	SOT223	Tube	80	AUIPS2051L
		Tape and reel	2500	AUIPS2051LTR
AUIPS2052G	SO8	Tube	95	AUIPS2052G
		Tape and reel	2500	AUIPS2052GTR

## IMPORTANT NOTICE

Unless specifically designated for the automotive market, International Rectifier Corporation and its subsidiaries (IR) reserve the right to make corrections, modifications, enhancements, improvements, and other changes to its products and services at any time and to discontinue any product or services without notice. Part numbers designated with the "AU" prefix follow automotive industry and / or customer specific requirements with regards to product discontinuance and process change notification. All products are sold subject to IR's terms and conditions of sale supplied at the time of order acknowledgment.

IR warrants performance of its hardware products to the specifications applicable at the time of sale in accordance with IR's standard warranty. Testing and other quality control techniques are used to the extent IR deems necessary to support this warranty. Except where mandated by government requirements, testing of all parameters of each product is not necessarily performed.

IR assumes no liability for applications assistance or customer product design. Customers are responsible for their products and applications using IR components. To minimize the risks with customer products and applications, customers should provide adequate design and operating safeguards.

Reproduction of IR information in IR data books or data sheets is permissible only if reproduction is without alteration and is accompanied by all associated warranties, conditions, limitations, and notices. Reproduction of this information with alterations is an unfair and deceptive business practice. IR is not responsible or liable for such altered documentation. Information of third parties may be subject to additional restrictions.

Resale of IR products or serviced with statements different from or beyond the parameters stated by IR for that product or service voids all express and any implied warranties for the associated IR product or service and is an unfair and deceptive business practice. IR is not responsible or liable for any such statements.

IR products are not designed, intended, or authorized for use as components in systems intended for surgical implant into the body, or in other applications intended to support or sustain life, or in any other application in which the failure of the IR product could create a situation where personal injury or death may occur. Should Buyer purchase or use IR products for any such unintended or unauthorized application, Buyer shall indemnify and hold International Rectifier and its officers, employees, subsidiaries, affiliates, and distributors harmless against all claims, costs, damages, and expenses, and reasonable attorney fees arising out of, directly or indirectly, any claim of personal injury or death associated with such unintended or unauthorized use, even if such claim alleges that IR was negligent regarding the design or manufacture of the product.

IR products are neither designed nor intended for use in military/aerospace applications or environments unless the IR products are specifically designated by IR as military-grade or "enhanced plastic." Only products designated by IR as military-grade meet military specifications. Buyers acknowledge and agree that any such use of IR products which IR has not designated as military-grade is solely at the Buyer's risk, and that they are solely responsible for compliance with all legal and regulatory requirements in connection with such use.

IR products are neither designed nor intended for use in automotive applications or environments unless the specific IR products are designated by IR as compliant with ISO/TS 16949 requirements and bear a part number including the designation "AU". Buyers acknowledge and agree that, if they use any non-designated products in automotive applications, IR will not be responsible for any failure to meet such requirements.

For technical support, please contact IR's Technical Assistance Center  
<http://www.irf.com/technical-info/>

**WORLD HEADQUARTERS:**

101 N Sepulveda Blvd., El Segundo, California 90245  
Tel: (310) 252-7105

**Revision History**

<b>Revision</b>	<b>Date</b>	<b>Notes/Changes</b>
A	30/10/08	First release
B	23/03/2009	Add latch up information
C	15/09/2009	Add application section
D	21/02/2011	Update Fig 11
E	November, 14 <sup>th</sup> 2011	Update T&R SOT223
F	May 9 <sup>th</sup> , 2012	Update the component number of the SOT223 tube