

7-180984-0 ✓ ACTIVE

FASTON | FASTON 250

TE Internal #: 7-180984-0

Crimp Terminal Housings, Receptacle, Receptacle, 1 Position, Flag,
UL 94V-0, Natural, Polyamide, Cable Mount (Free-Hanging),
FASTON 250

[View on TE.com >](#)



Terminals & Splices > Terminal Housings, Insulation Sleeves & Blocks > Crimp Terminal Housings



Terminal Type: **Receptacle**

Connector & Housing Type: **Receptacle**

Number of Positions: **1**

Terminal Orientation: **Flag**

UL Flammability Rating: **UL 94V-0**

Features

Product Type Features

Sealable	No
Connector & Contact Terminates To	Wire & Cable
Connector & Housing Type	Receptacle

Configuration Features

Number of Positions	1
---------------------	---

Body Features

Primary Product Color	Natural
-----------------------	---------

Contact Features

Terminal Type	Receptacle
Terminal Orientation	Flag
Contact Mating Retention	Without

Mechanical Attachment

Mating Alignment Type	None
-----------------------	------



Mating Alignment	Without
Connector Mounting Type	Cable Mount (Free-Hanging)

Housing Features

Housing Material	Polyamide
------------------	-----------

Dimensions

Product Length	40.2 mm[1.582 in]
----------------	-------------------

Usage Conditions

Operating Temperature Range	-40 – 105 °C[-40 – 221 °F]
-----------------------------	----------------------------

Industry Standards

UL Flammability Rating	UL 94V-0
------------------------	----------

Packaging Features

Packaging Quantity	100
--------------------	-----

Other

Crimp Terminal Housing Comment	Slide on from front.
--------------------------------	----------------------

Product Compliance

[For compliance documentation, visit the product page on TE.com>](#)

EU RoHS Directive 2011/65/EU	Compliant
EU ELV Directive 2000/53/EC	Compliant
China RoHS 2 Directive MIIT Order No 32, 2016	No Restricted Materials Above Threshold
EU REACH Regulation (EC) No. 1907/2006	Current ECHA Candidate List: JUNE 2023 (235) Candidate List Declared Against: JAN 2023 (233) Does not contain REACH SVHC
Halogen Content	Low Halogen - Br, Cl, F, I < 900 ppm per homogenous material. Also BFR/CFR/PVC Free
Solder Process Capability	Not applicable for solder process capability

Product Compliance Disclaimer

This information is provided based on reasonable inquiry of our suppliers and represents our current actual knowledge based on the information they provided. This information is subject to change. The part numbers that TE has identified as EU RoHS compliant have a maximum concentration of 0.1% by weight in homogenous materials for lead, hexavalent chromium, mercury, PBB, PBDE, DBP, BBP, DEHP, DIBP, and 0.01% for cadmium, or qualify for an exemption to these limits as defined in the Annexes of Directive 2011/65/EU (RoHS2). Finished electrical and electronic equipment products will be CE marked as required by Directive 2011/65/EU. Components may not be CE marked. Additionally, the part numbers that TE has identified as EU ELV compliant have a maximum concentration of 0.1% by weight in homogenous

materials for lead, hexavalent chromium, and mercury, and 0.01% for cadmium, or qualify for an exemption to these limits as defined in the Annexes of Directive 2000/53/EC (ELV). Regarding the REACH Regulation, the information TE provides on SVHC in articles for this part number is based on the latest European Chemicals Agency (ECHA) 'Guidance on requirements for substances in articles' posted at this URL: <https://echa.europa.eu/guidance-documents/guidance-on-reach>

Compatible Parts



TE Part # 2-180930-1
250 FASTON HSG.,REC.,1 POS,RED



TE Part # 180464-1
250 FASTON,FLAG,REC.,14-17AWG, LATON



TE Part # 2-180930-5
250 FASTON HSG.,REC.,1 POS,BLACK



TE Part # 2-180930-0
250 FASTON HSG.,REC.,1 POS, NATURAL



TE Part # 8-180984-2
250 FASTON BOOT FLAG REC. 1P NATURAL



TE Part # 881339-2
SLEEVE FOR .250 SRS FASTON TAB

Also in the Series | FASTON 250



Compression Connectors(4)

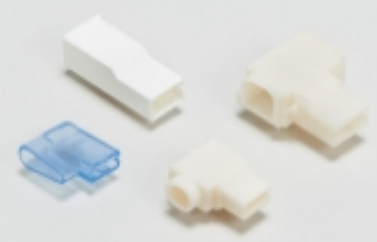

Crimp Terminal Housings(142)



Insertion & Extraction Tools(6)



Magnet Wire Terminals(1)



PCB Terminals(135)



Quick Disconnects(445)



Splices(4)

Customers Also Bought



TE Part #1-1718346-3
MQS, CONNECTOR HOUSING



TE Part #180464-2
250 FASTON, FLAG, REC., 14-17AWG,
LATON



TE Part #62336-1
110 FASTON FLAG REC 22-18 AWG
TPBR



TE Part #281828-2
PL 2.5-4.0 MM2 TPBR



TE Part #1-963736-2
TAB 5.8x0.8 CONTACT CS SRC Ag



TE Part #1-2177909-2
MCON 0.5 CB, CONTACT

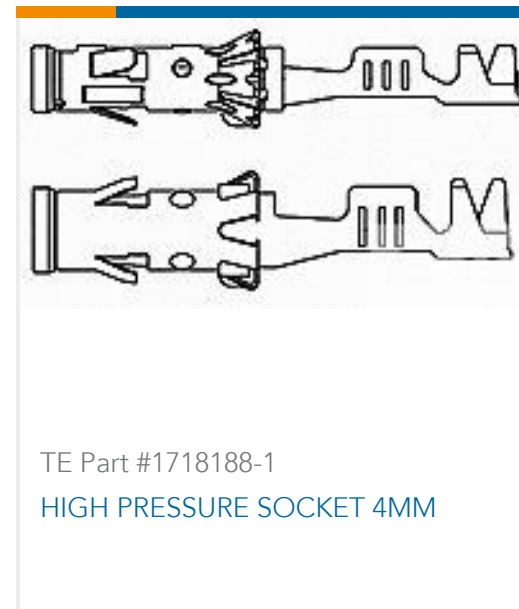

TE Part #1718188-1
HIGH PRESSURE SOCKET 4MM

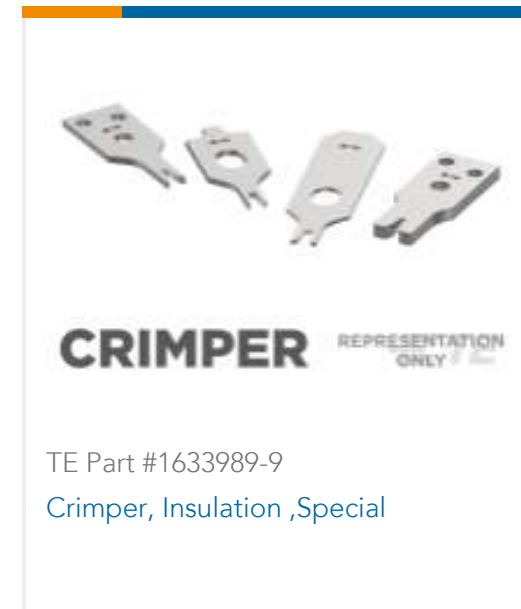

TE Part #1633989-9
Crimper, Insulation, Special



TE Part #281991-2
HSG FOR P-LOCK MK I TERM

Documents

CAD Files

3D PDF

3D

Customer View Model

[ENG_CVM_CVM_7-180984-0_AY.2d_dxf.zip](#)

English

Customer View Model

[ENG_CVM_CVM_7-180984-0_AY.3d_igs.zip](#)

English

Customer View Model

[ENG_CVM_CVM_7-180984-0_AY.3d_stp.zip](#)

English

By downloading the CAD file I accept and agree to the [Terms and Conditions](#) of use.

Product Specifications

[Blocchetto di protezione per capicorda lamellari femmina a bandiera serie .250](#)

[Product Specification](#)

Product Environmental Compliance



Product Compliance

English

Product Compliance

English