

ORDER NO.	WOODHEAD NO.	COLOR
130147-0290	29W08-P	YELLOW

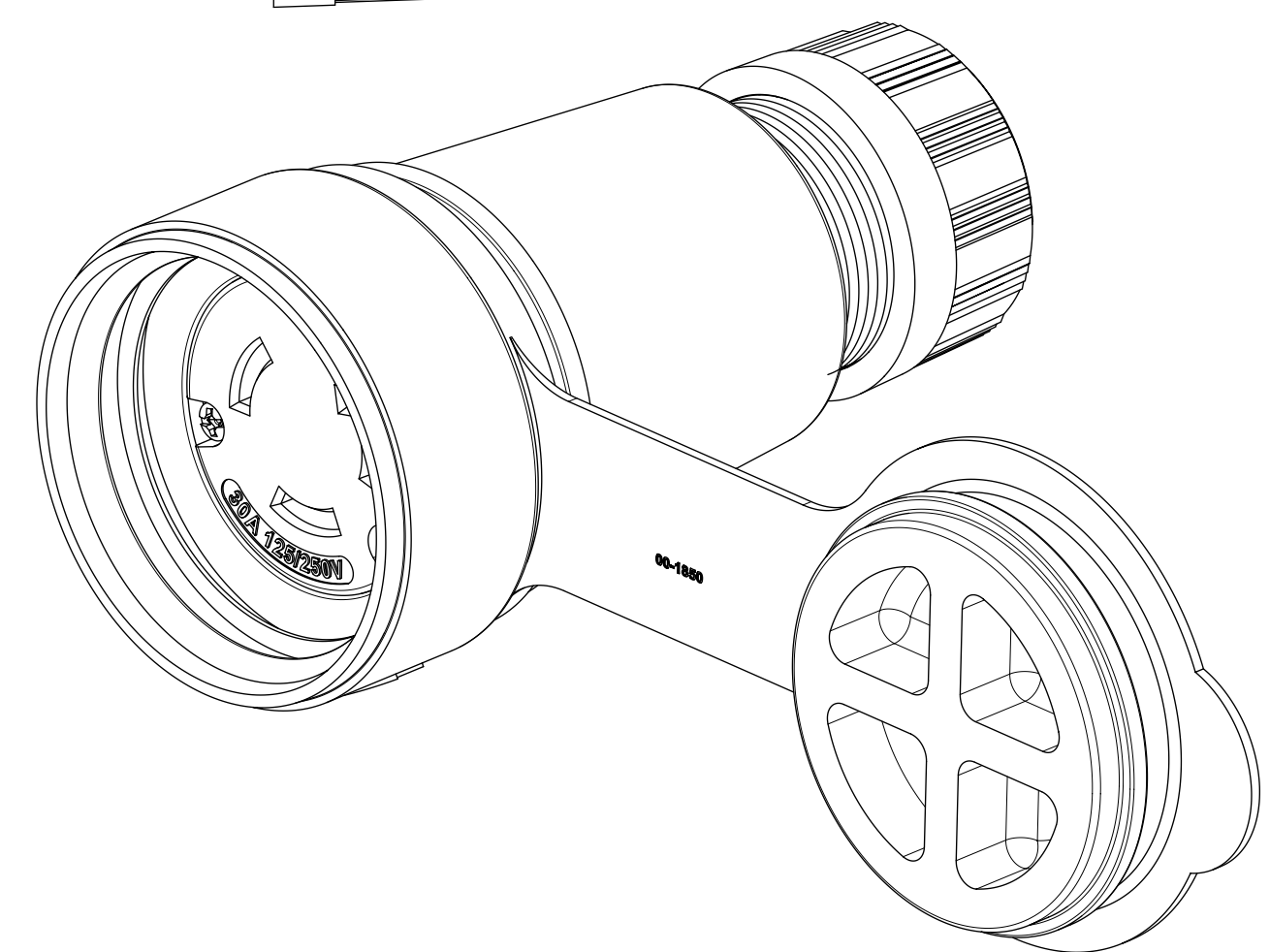
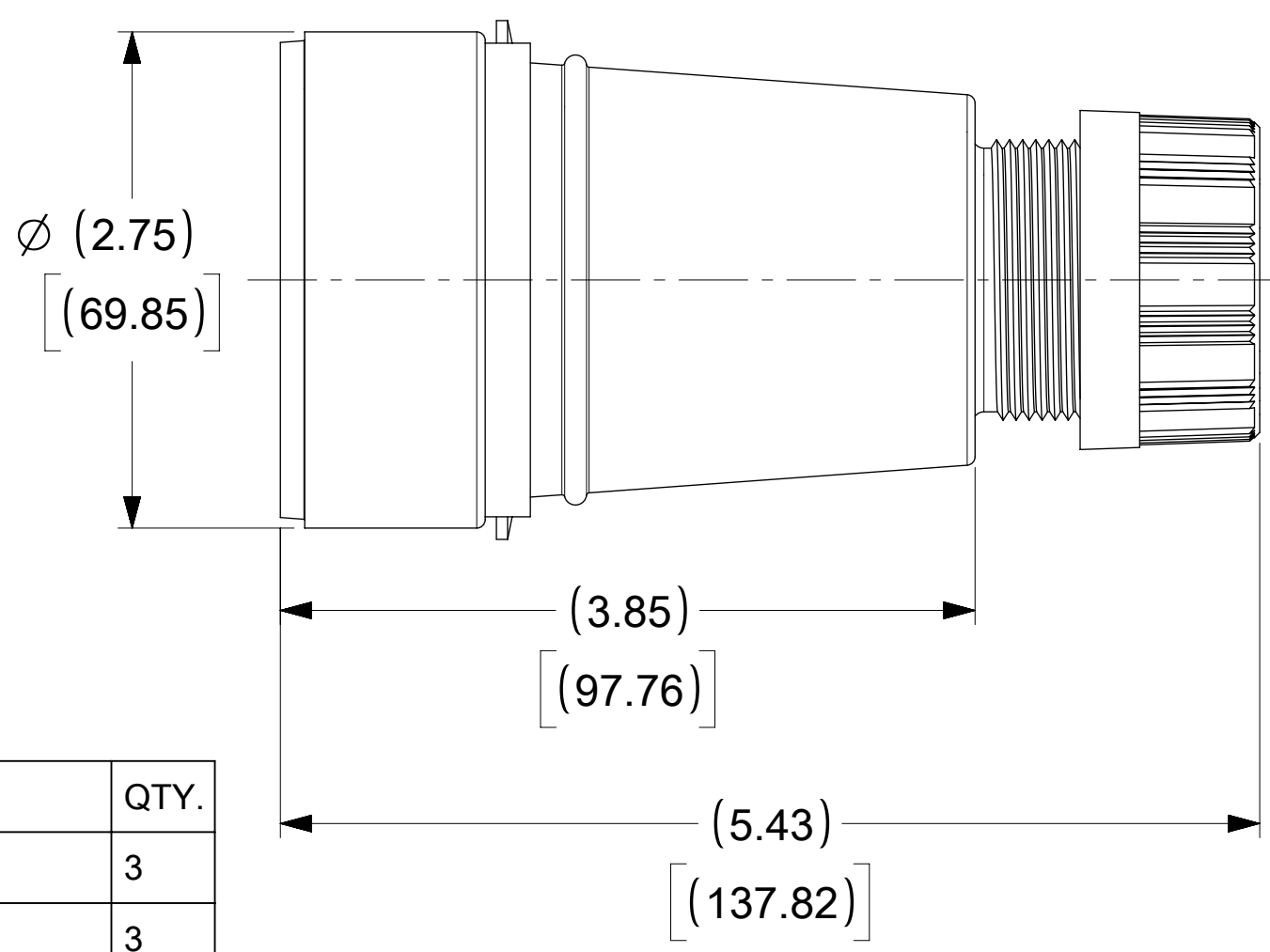
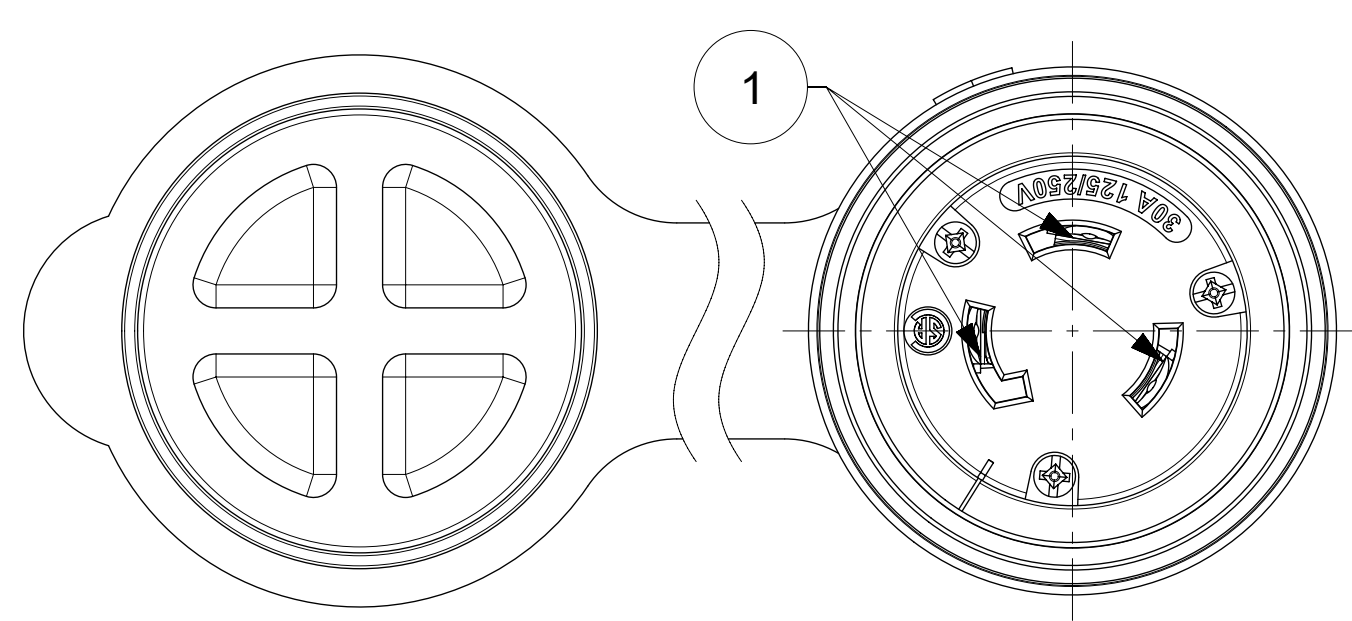
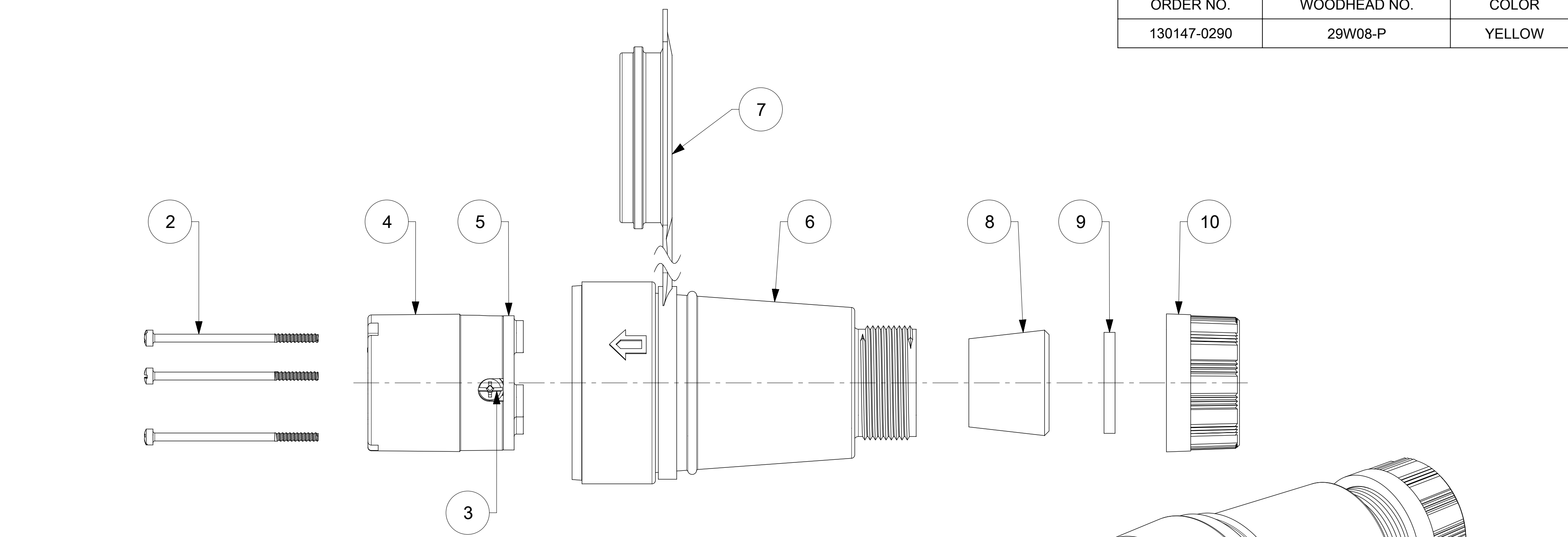

ITEM NO.	DESCRIPTIONS	MATERIAL	QTY.
1	BLADE	BRASS, NICKEL PLATED	3
2	RETAINING SCREWS	STAINLESS STEEL	3
3	CLAMP AND TERMINAL SCREW ASSY	BRASS, ZINC PLATED	3
4	INSERT	NYLON	1
5	TERMINAL COVER	POLYCARBONATE	1
6	HOUSING	SILICON WITH NYLON THREAD	1
7	COVER CLOSURE	SILICON WITH NYLON THREAD	1
8	GROMMET	RUBBER	1
9	FRICTION RING	NYLON	1
10	COMPRESSION NUT	NYLON	1

SYMBOLS THIS DRAWING CONTAINS INFORMATION THAT IS PROPRIETARY TO MOLEX ELECTRONIC TECHNOLOGIES, LLC AND SHOULD NOT BE USED WITHOUT WRITTEN PERMISSION DIMENSION UNITS: INCH[MM] SCALE: NTS GENERAL TOLERANCES (UNLESS SPECIFIED): 4 PLACES ± ± 3 PLACES ± ± 2 PLACES ± ± 1 PLACE ± ± 0 PLACES ± ± ANGULAR TOL ± ° DRAFT WHERE APPLICABLE MUST REMAIN WITHIN DIMENSIONS THIRD ANGLE PROJECTION DRAWING SERIES: C-SIZE 130147		CURRENT REV DESC: RELEASED EC NO: 614381 DRWN: DSOPPIN 2018/12/27 CHK'D: DNGUYEN62 2019/04/16 APPR: HKNEELAND 2019/04/25 INITIAL REVISION: DRWN: DSOPPIN 2018/12/27 APPR: HKNEELAND 2019/04/25	 WATERTITE CONNECTOR TURNEX 3P3W NON-NEMA PRODUCT CUSTOMER DRAWING DOCUMENT NUMBER: 1301470290 DOC TYPE: PSD DOC PART: 000 REVISION: A MATERIAL NUMBER: SEE TABLE CUSTOMER: GENERAL MARKET SHEET NUMBER: 1 OF 1
--	--	---	--