

FEATURES

- High relative accuracy (INL): ±4 LSB maximum at 16 bits**
- Low drift 2.5 V reference: 4 ppm/°C typical**
- Tiny package: 3 mm × 3 mm, 16-lead LFCSP**
- Total unadjusted error (TUE): ±0.1% of FSR maximum**
- Offset error: ±1.5 mV maximum**
- Gain error: ±0.1% of FSR maximum**
- High drive capability: 15 mA, 0.5 V from supply rails**
- User selectable gain of 1 or 2 (GAIN pin)**
- Reset to zero scale or midscale (RSTSEL pin)**
- 1.8 V logic compatibility**
- 50 MHz SPI with readback or daisy chain**
- Low glitch: 0.5 nV-sec**
- Low power: 3.3 mW at 3 V**
- 2.7 V to 5.5 V power supply**

ENHANCED PRODUCT FEATURES

- Supports defense and aerospace applications (AQEC)**
- Temperature range: -55°C to +125°C**
- Controlled manufacturing baseline**
- 1 assembly/test site**
- 1 fabrication site**
- Enhanced product change notification**
- Qualification data available on request**

APPLICATIONS

- Optical transceivers**
- Base-station power amplifiers**
- Process control (PLC input/output cards)**
- Industrial automation**
- Data acquisition systems**

GENERAL DESCRIPTION

The [AD5686R-EP](#), a member of the *nanoDAC+* family, is a low power, quad, 16-bit buffered voltage output digital-to-analog converter (DAC). The device includes a 2.5 V, 4 ppm/°C internal reference (enabled by default) and a gain select pin giving a full-scale output of 2.5 V (gain = 1) or 5 V (gain = 2). The device operates from a single 2.7 V to 5.5 V supply, is guaranteed monotonic by design, and exhibits less than 0.1% FSR gain error and 1.5 mV offset error performance. The device is available in a 3 mm × 3 mm LFCSP package.

The [AD5686R-EP](#) also incorporates a power-on reset circuit and a RSTSEL pin that ensures that the DAC outputs power up to zero scale or midscale and remains there until a valid write occurs. The device contains a per-channel power-down feature that

FUNCTIONAL BLOCK DIAGRAM

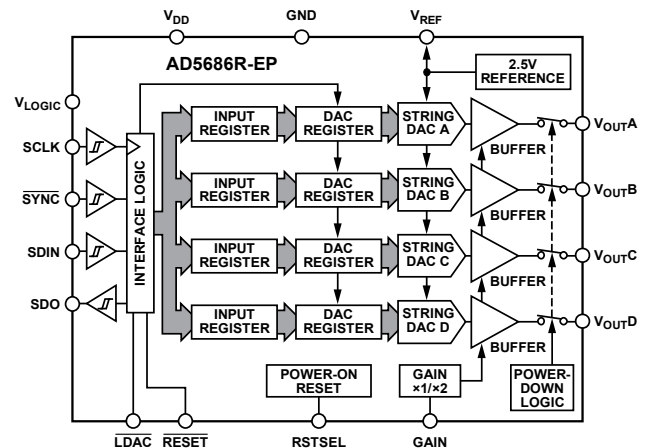

Figure 1.

reduces the current consumption of the device to 4 µA at 3 V while in power-down mode.

The [AD5686R-EP](#) employs a versatile serial peripheral interface (SPI) that operates at clock rates up to 50 MHz, and contains a V_{LOGIC} pin that is intended for 1.8 V/3 V/5 V logic.

Additional application and technical information can be found in the [AD5686R/AD5685R/AD5684R](#) data sheet.

PRODUCT HIGHLIGHTS

1. High Relative Accuracy (INL).
±4 LSB maximum.
2. Low Drift 2.5 V On-Chip Reference.
4 ppm/°C typical temperature coefficient.
13 ppm/°C maximum temperature coefficient.

Rev. A

[Document Feedback](#)

Information furnished by Analog Devices is believed to be accurate and reliable. However, no responsibility is assumed by Analog Devices for its use, nor for any infringements of patents or other rights of third parties that may result from its use. Specifications subject to change without notice. No license is granted by implication or otherwise under any patent or patent rights of Analog Devices. Trademarks and registered trademarks are the property of their respective owners.

TABLE OF CONTENTS

Features	1	Timing Characteristics	6
Enhanced Product Features	1	Daisy-Chain and Readback Timing Characteristics	7
Applications	1	Absolute Maximum Ratings	9
Functional Block Diagram	1	ESD Caution.....	9
General Description	1	Pin Configuration and Function Descriptions.....	10
Product Highlights	1	Typical Performance Characteristics	11
Revision History	2	Outline Dimensions	17
Specifications.....	3	Ordering Guide	17
AC Characteristics.....	5		

REVISION HISTORY

11/2016—Rev. 0 to Rev. A

Changed $1.8\text{ V} \leq V_{\text{LOGIC}} \leq 5.5\text{ V}$ to	
$1.62\text{ V} \leq V_{\text{LOGIC}} \leq 5.5\text{ V}$	Throughout
Changes to Features Section.....	1
Changes to V_{LOGIC} Parameter, Table 1.....	4
Changes to Output Noise Spectral Density (NSD) Parameter,	
Test Conditions/Comments Column, Table 2.....	5
Changes to Table 3.....	6
Changes to Table 4 and Figure 4.....	7
Changes to Figure 5.....	8
Deleted ESD Parameter, Table 5 and FICDM Parameter, Table 5....	9
Changes to Pin 9 Description Column, Table 6 and Pin 13	
Description Column, Table 6.....	10
Changes to Figure 9.....	11
Changes to Figure 15 to Figure 18.....	12
Changes to Figure 19 to Figure 23.....	13
Changes to Figure 25, Figure 26, and Figure 29	14
Changes to Figure 31 and Figure 36.....	16
Changes to Figure 37.....	16

7/2015—Revision 0: Initial Version

SPECIFICATIONS

$V_{DD} = 2.7\text{ V to }5.5\text{ V}$, $1.62\text{ V} \leq V_{LOGIC} \leq 5.5\text{ V}$, all specifications T_{MIN} to T_{MAX} , unless otherwise noted. $R_L = 2\text{ k}\Omega$; $C_L = 200\text{ pF}$.

Table 1.

Parameter	Min	Typ	Max	Unit	Test Conditions/Comments
STATIC PERFORMANCE¹					
Resolution	16			Bits	
Relative Accuracy		± 1	± 4	LSB	Gain = 2
		± 1	± 5	LSB	Gain = 1
Differential Nonlinearity (DNL)			± 1	LSB	Guaranteed monotonic by design
Zero-Code Error		0.4	1.5	mV	All zeros loaded to DAC register
Offset Error		+0.1	± 1.5	mV	
Full-Scale Error		+0.01	± 0.1	% of FSR	All ones loaded to DAC register
Gain Error		± 0.02	± 0.1	% of FSR	Gain = 2
		± 0.02	± 0.15	% of FSR	Gain = 1
Total Unadjusted Error		± 0.01	± 0.1	% of FSR	External reference; gain = 2
			± 0.2	% of FSR	Internal reference; gain = 1
Offset Error Drift ²		± 1		$\mu\text{V}/^\circ\text{C}$	
Gain Temperature Coefficient (TC) ²		± 1		ppm	Of FSR/ $^\circ\text{C}$
DC Power Supply Rejection Ratio ²		0.15		mV/V	DAC code = midscale; $V_{DD} = 5\text{ V} \pm 10\%$
DC Crosstalk ²					
		± 2		μV	Due to single channel, full-scale output change
		± 3		$\mu\text{V}/\text{mA}$	Due to load current change
		± 2		μV	Due to powering down (per channel)
OUTPUT CHARACTERISTICS²					
Output Voltage Range	0		V_{REF}	V	Gain = 1
	0		$2 \times V_{REF}$	V	Gain = 2, see Figure 27
Capacitive Load Stability		2		nF	$R_L = \infty$
		10		nF	$R_L = 1\text{ k}\Omega$
Resistive Load ³	1			k Ω	
Load Regulation		80		$\mu\text{V}/\text{mA}$	$5\text{ V} \pm 10\%$, DAC code = midscale; $-30\text{ mA} \leq I_{OUT} \leq 30\text{ mA}$
		80		$\mu\text{V}/\text{mA}$	$3\text{ V} \pm 10\%$, DAC code = midscale; $-20\text{ mA} \leq I_{OUT} \leq 20\text{ mA}$
Short-Circuit Current ⁴		40		mA	
Load Impedance at Rails ⁵		25		Ω	See Figure 27
Power-Up Time		2.5		μs	Coming out of power-down mode; $V_{DD} = 5\text{ V}$
REFERENCE OUTPUT					
Output Voltage ⁶	2.4975		2.5025	V	At ambient
Reference TC ^{7, 8}		4	13	ppm/ $^\circ\text{C}$	
Output Impedance ²		0.04		Ω	
Output Voltage Noise ²		12		$\mu\text{V p-p}$	0.1 Hz to 10 Hz
Output Voltage Noise Density ²		240		nV/ $\sqrt{\text{Hz}}$	At ambient; $f = 10\text{ kHz}$, $C_L = 10\text{ nF}$
Load Regulation Sourcing ²		20		$\mu\text{V}/\text{mA}$	At ambient
Load Regulation Sinking ²		40		$\mu\text{V}/\text{mA}$	At ambient
Output Current Load Capability ²		± 5		mA	$V_{DD} \geq 3\text{ V}$
Line Regulation ²		100		$\mu\text{V}/\text{V}$	At ambient
Thermal Hysteresis ²		125		ppm	First cycle
		25		ppm	Additional cycles
LOGIC INPUTS²					
Input Current			± 2	μA	Per pin
Input Voltage					
Low (V_{INL})			$0.3 \times V_{LOGIC}$	V	
High (V_{INH})	$0.7 \times V_{LOGIC}$			V	
Pin Capacitance		2		pF	

Parameter	Min	Typ	Max	Unit	Test Conditions/Comments
LOGIC OUTPUTS (SDO)²					
Output Voltage					
Low (V_{OL})			0.4	V	$I_{SINK} = 200 \mu A$
High (V_{OH})	$V_{LOGIC} - 0.4$			V	$I_{SOURCE} = 200 \mu A$
Floating State Output Capacitance		4		pF	
POWER REQUIREMENTS					
V_{LOGIC}	1.62		5.5	V	
I_{LOGIC}			3	μA	
V_{DD}	2.7		5.5	V	Gain = 1
V_{DD}	$V_{REF} + 1.5$		5.5	V	Gain = 2
I_{DD}					$V_{IH} = V_{DD}, V_{IL} = GND, V_{DD} = 2.7 V \text{ to } 5.5 V$
Normal Mode ⁹		0.59	0.7	mA	Internal reference off
		1.1	1.3	mA	Internal reference on, at full scale
All Power-Down Modes ¹⁰		1	4	μA	$-40^{\circ}C \text{ to } +85^{\circ}C$
			6	μA	$-55^{\circ}C \text{ to } +125^{\circ}C$

¹ DC specifications tested with the outputs unloaded, unless otherwise noted. Upper dead band = 10 mV and exists only when $V_{REF} = V_{DD}$ with gain = 1 or when $V_{REF}/2 = V_{DD}$ with gain = 2. Linearity calculated using a reduced code range of 256 to 65,280.

² Guaranteed by design and characterization; not production tested.

³ Channel A and Channel B can have a combined output current of up to 15 mA. Similarly, Channel C and Channel D can have a combined output current of up to 15 mA up to a junction temperature of 135°C.

⁴ $V_{DD} = 5 V$. The device includes current limiting that is intended to protect the device during temporary overload conditions. Junction temperature can be exceeded during current limit. Operation above the specified maximum operation junction temperature may impair device reliability.

⁵ When drawing a load current at either rail, the output voltage headroom, with respect to that rail, is limited by the 25 Ω typical channel resistance of the output device. For example, when sinking 1 mA, the minimum output voltage = $25 \Omega \times 1 \text{ mA} = 25 \text{ mV}$ (see Figure 27).

⁶ Initial accuracy presolder reflow is $\pm 750 \mu V$; output voltage includes the effects of preconditioning drift. See the [AD5686R/AD5685R/AD5684R](#) data sheet for more information.

⁷ Reference is trimmed and tested at two temperatures and is characterized from $-55^{\circ}C$ to $+125^{\circ}C$.

⁸ Reference temperature coefficient calculated as per the box method. See the [AD5686R/AD5685R/AD5684R](#) data sheet for further information.

⁹ Interface inactive. All DACs active. DAC outputs unloaded.

¹⁰ All DACs powered down.

AC CHARACTERISTICS

$V_{DD} = 2.7\text{ V to }5.5\text{ V}$, $R_L = 2\text{ k}\Omega\text{ to GND}$, $C_L = 200\text{ pF to GND}$, $1.62\text{ V} \leq V_{LOGIC} \leq 5.5\text{ V}$, and all specifications T_{MIN} to T_{MAX} , unless otherwise noted. Guaranteed by design and characterization, not production tested.

Table 2.

Parameter ¹	Min	Typ	Max	Unit	Test Conditions/Comments ²
Output Voltage Settling Time		5	8	μs	$\frac{1}{4}$ to $\frac{3}{4}$ scale settling to ± 2 LSB
Slew Rate		0.8		$\text{V}/\mu\text{s}$	
Digital-to-Analog Glitch Impulse		0.5		$\text{nV}\text{-sec}$	1 LSB change around major carry
Digital Feedthrough		0.13		$\text{nV}\text{-sec}$	
Digital Crosstalk		0.1		$\text{nV}\text{-sec}$	
Analog Crosstalk		0.2		$\text{nV}\text{-sec}$	
DAC-to-DAC Crosstalk		0.3		$\text{nV}\text{-sec}$	
Total Harmonic Distortion (THD) ³		-80		dB	At ambient, bandwidth (BW) = 20 kHz, $V_{DD} = 5\text{ V}$, $f_{OUT} = 1\text{ kHz}$
Output Noise Spectral Density (NSD)		300		$\text{nV}/\sqrt{\text{Hz}}$	DAC code = midscale, 10 kHz; gain = 2, internal reference
Output Noise		6		$\mu\text{V p-p}$	0.1 Hz to 10 Hz
Signal-to-Noise Ratio (SNR)		90		dB	At ambient, BW = 20 kHz, $V_{DD} = 5\text{ V}$, $f_{OUT} = 1\text{ kHz}$
Spurious Free Dynamic Range (SFDR)		83		dB	At ambient, BW = 20 kHz, $V_{DD} = 5\text{ V}$, $f_{OUT} = 1\text{ kHz}$
Signal-to-Noise-and-Distortion Ratio (SINAD)		80		dB	At ambient, BW = 20 kHz, $V_{DD} = 5\text{ V}$, $f_{OUT} = 1\text{ kHz}$

¹ See the [AD5686R/AD5685R/AD5684R](#) data sheet.

² Temperature range is -55°C to $+125^\circ\text{C}$, typical at 25°C .

³ Digitally generated sine wave at 1 kHz.

TIMING CHARACTERISTICS

All input signals are specified with $t_R = t_F = 1 \text{ ns/V}$ (10% to 90% of V_{DD}) and timed from a voltage level of $(V_{IL} + V_{IH})/2$. See Figure 2. $V_{DD} = 2.7 \text{ V}$ to 5.5 V , $1.62 \text{ V} \leq V_{LOGIC} \leq 5.5 \text{ V}$, and $V_{REF} = 2.5 \text{ V}$. All specifications T_{MIN} to T_{MAX} , unless otherwise noted.

Table 3

Parameter ¹	Symbol	1.62 V ≤ V _{LOGIC} < 2.7 V		2.7 V ≤ V _{LOGIC} ≤ 5.5 V		Unit
		Min	Max	Min	Max	
SCLK Cycle Time	t ₁	20		20		ns
SCLK High Time	t ₂	10		10		ns
SCLK Low Time	t ₃	10		10		ns
SYNC to SCLK Falling Edge Setup Time	t ₄	15		10		ns
Data Setup Time	t ₅	5		5		ns
Data Hold Time	t ₆	5		5		ns
SCLK Falling Edge to SYNC Rising Edge	t ₇	10		10		ns
Minimum SYNC High Time	t ₈	20		20		ns
SYNC Rising Edge to SYNC Rising Edge (DAC Register Update/s)	t ₉	870		830		ns
SYNC Falling Edge to SCLK Fall Ignore	t ₁₀	16		10		ns
LDAC Pulse Width Low	t ₁₁	15		15		ns
SYNC Rising Edge to LDAC Rising Edge	t ₁₂	20		20		ns
SYNC Rising Edge to LDAC Falling Edge	t ₁₃	30		30		ns
LDAC Falling Edge to SYNC Rising Edge	t ₁₄	840		800		ns
Minimum Pulse Width Low	t ₁₅	30		30		ns
Pulse Activation Time	t ₁₆	30		30		ns
Power-Up Time ²		4.5		4.5		μs

¹Guaranteed by design and characterization; not production tested.

²Time to exit power-down to normal mode of AD5686R-EP operation, SYNC rising edge to 90% of DAC midscale value, with output unloaded.

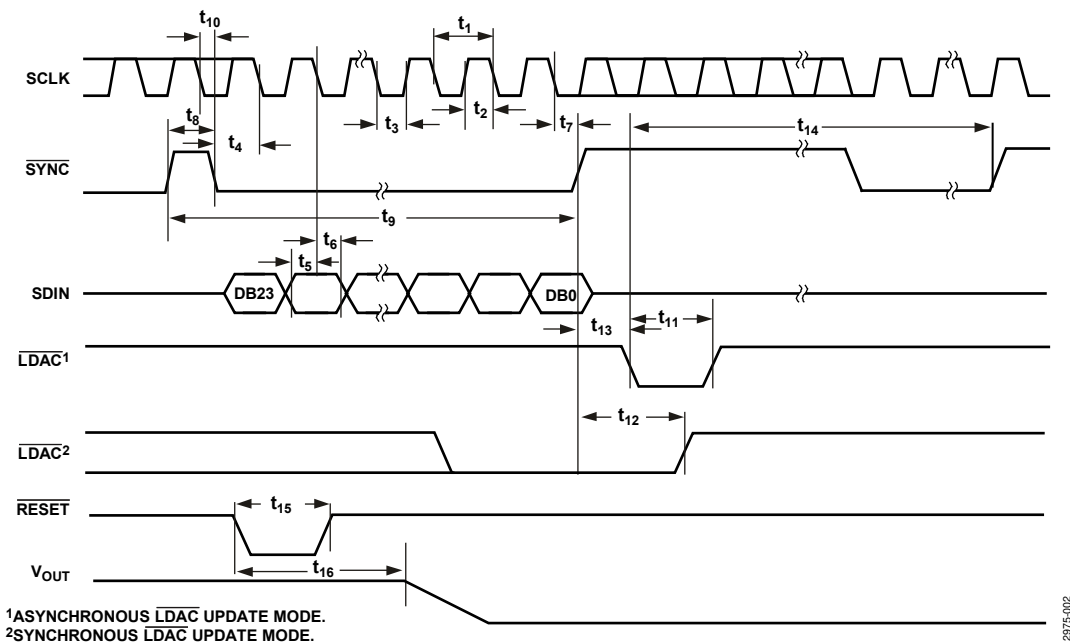

Figure 2. Serial Write Operation

DAISY-CHAIN AND READBACK TIMING CHARACTERISTICS

All input signals are specified with $t_R = t_F = 1 \text{ ns/V}$ (10% to 90% of V_{DD}) and timed from a voltage level of $(V_{IL} + V_{IH})/2$. See Figure 4 and Figure 5. $V_{DD} = 2.7 \text{ V}$ to 5.5 V , $1.62 \text{ V} \leq V_{LOGIC} \leq 5.5 \text{ V}$, and $V_{REF} = 2.5 \text{ V}$. All specifications T_{MIN} to T_{MAX} , unless otherwise noted.

Table 4.

Parameter ¹	Symbol	1.62 V ≤ V _{LOGIC} < 2.7 V		2.7 V ≤ V _{LOGIC} ≤ 5.5 V		Unit
		Min	Max	Min	Max	
SCLK Cycle Time	t ₁	66		40		ns
SCLK High Time	t ₂	33		20		ns
SCLK Low Time	t ₃	33		20		ns
SYNC to SCLK Falling Edge	t ₄	33		20		ns
Data Setup Time	t ₅	5		5		ns
Data Hold Time	t ₆	5		5		ns
SCLK Falling Edge to SYNC Rising Edge	t ₇	15		10		ns
Minimum SYNC High Time	t ₈	60		30		ns
SDO Data Valid from SCLK Rising Edge	t ₉		45		30	ns
SYNC Rising Edge to SCLK Rising Edge	t ₁₀	15		10		ns
SYNC Rising Edge to SDO Disable	t ₁₁	60		60		ns

¹ Guaranteed by design and characterization; not production tested.

Circuit and Timing Diagrams

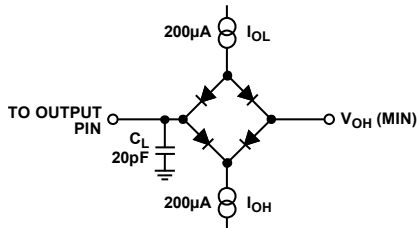

Figure 3. Load Circuit for Digital Output (SDO) Timing Specifications

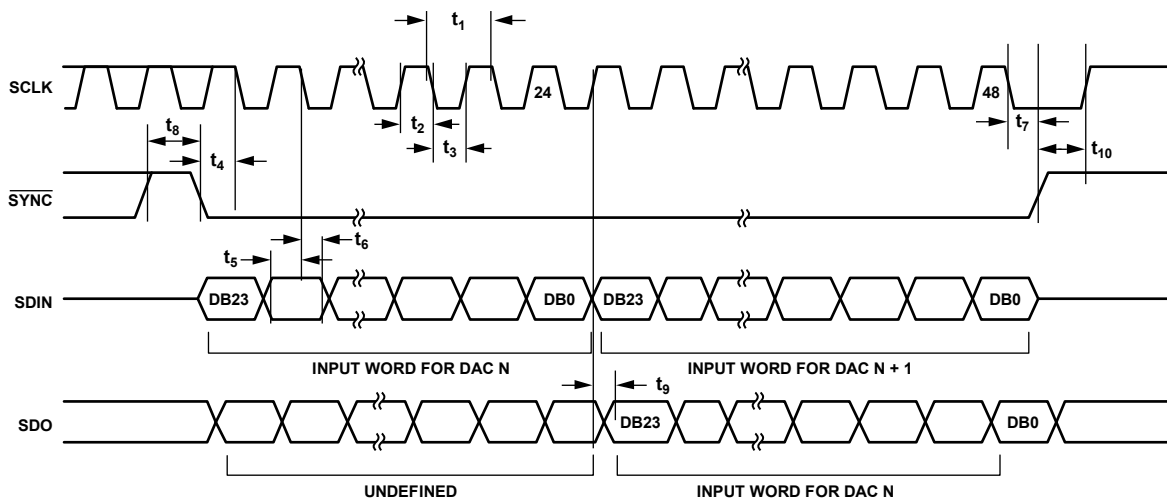

Figure 4. Daisy-Chain Timing Diagram

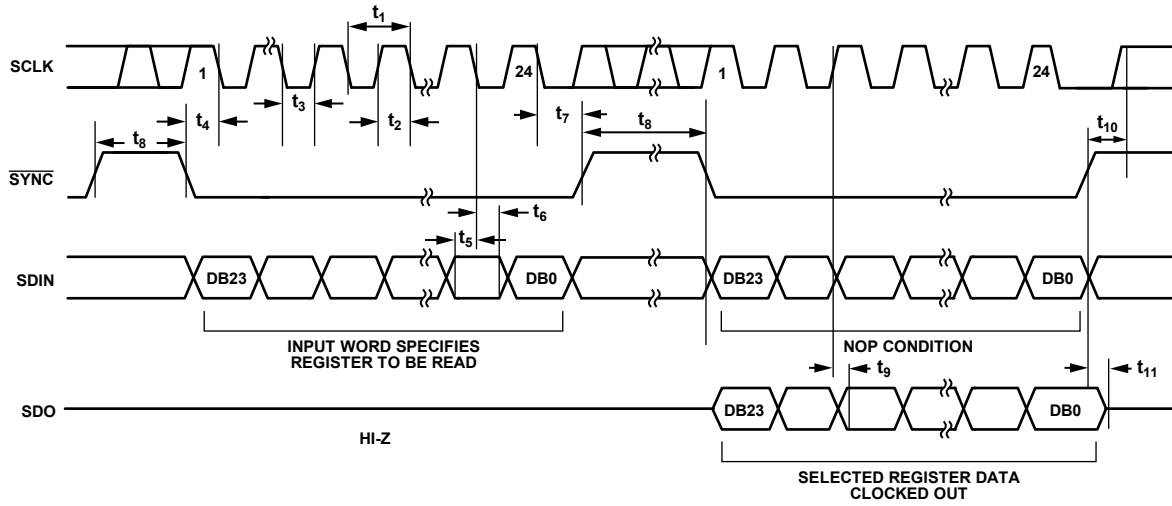

Figure 5. Readback Timing Diagram

12975-005

ABSOLUTE MAXIMUM RATINGS

$T_A = 25^\circ\text{C}$, unless otherwise noted.

Table 5.

Parameter	Rating
V_{DD} to GND	-0.3 V to +7 V
V_{LOGIC} to GND	-0.3 V to +7 V
V_{OUT} to GND	-0.3 V to $V_{DD} + 0.3$ V
V_{REF} to GND	-0.3 V to $V_{DD} + 0.3$ V
Digital Input Voltage to GND	-0.3 V to $V_{LOGIC} + 0.3$ V
Operating Temperature Range	-55°C to $+125^\circ\text{C}$
Storage Temperature Range	-65°C to $+150^\circ\text{C}$
Junction Temperature	135°C
16-Lead LFCSP, θ_{JA} Thermal Impedance, θ_{JA} Airflow (4-Layer Board)	$70^\circ\text{C}/\text{W}$
Reflow Soldering Peak Temperature, Pb Free (J-STD-020)	260°C

Stresses at or above those listed under Absolute Maximum Ratings may cause permanent damage to the product. This is a stress rating only; functional operation of the product at these or any other conditions above those indicated in the operational section of this specification is not implied. Operation beyond the maximum operating conditions for extended periods may affect product reliability.

ESD CAUTION



ESD (electrostatic discharge) sensitive device.

Charged devices and circuit boards can discharge without detection. Although this product features patented or proprietary protection circuitry, damage may occur on devices subjected to high energy ESD. Therefore, proper ESD precautions should be taken to avoid performance degradation or loss of functionality.

PIN CONFIGURATION AND FUNCTION DESCRIPTIONS

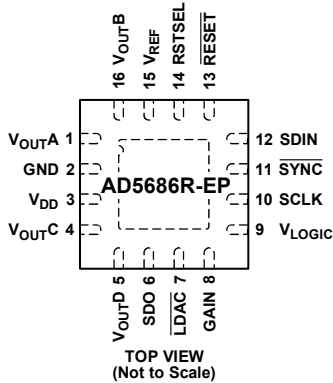

NOTES
1. THE EXPOSED PAD MUST BE TIED TO GND.

12975-006

Figure 6. 16-Lead LFCSP Pin Configuration

Table 6. Pin Function Descriptions

Pin No.	Mnemonic	Description
1	V _{OUTA}	Analog Output Voltage from DAC A. The output amplifier has rail-to-rail operation.
2	GND	Ground Reference Point for All Circuitry on the Device.
3	V _{DD}	Power Supply Input. The AD5686R-EP can be operated from 2.7 V to 5.5 V, and the supply must be decoupled with a 10 μF capacitor in parallel with a 0.1 μF capacitor to GND.
4	V _{OUTC}	Analog Output Voltage from DAC C. The output amplifier has rail-to-rail operation.
5	V _{OUTD}	Analog Output Voltage from DAC D. The output amplifier has rail-to-rail operation.
6	SDO	Serial Data Output. SDO can be used to daisy-chain a number of AD5686R-EP devices together, or it can be used for readback. The serial data is transferred on the rising edge of SCLK and is valid on the falling edge of the clock.
7	LDAC	LDAC can be operated in two modes, asynchronously and synchronously. Pulsing this pin low allows any or all DAC registers to be updated if the input registers have new data. This allows all DAC outputs to update simultaneously. This pin can also be tied permanently low.
8	GAIN	Span Set Pin. When this pin is tied to GND, all four DAC outputs have a span from 0 V to V _{REF} . If this pin is tied to V _{LOGIC} , all four DACs output a span of 0 V to 2 × V _{REF} .
9	V _{LOGIC}	Digital Power Supply. Voltage ranges from 1.62 V to 5.5 V.
10	SCLK	Serial Clock Input. Data is clocked into the input shift register on the falling edge of the serial clock input. Data can be transferred at rates of up to 50 MHz.
11	SYNC	Active Low Control Input. This is the frame synchronization signal for the input data. When SYNC goes low, data is transferred in on the falling edges of the next 24 clocks.
12	SDIN	Serial Data Input. This device has a 24-bit input shift register. Data is clocked into the register on the falling edge of the serial clock input.
13	RESET	Asynchronous Reset Input. The RESET input is falling edge sensitive. When RESET is low, all LDAC pulses are ignored. When RESET is activated, the input register and the DAC register are updated with zero scale or midscale, depending on the state of the RSTSEL pin. If this pin is forced low at power-up, the power-on reset (POR) circuit will not initialize the device correctly until this pin is released.
14	RSTSEL	Power-On Reset Pin. Tying this pin to GND powers up all four DACs to zero scale. Tying this pin to V _{LOGIC} powers up all four DACs to midscale.
15	V _{REF}	Reference Voltage. The AD5686R-EP has a common reference pin. When using the internal reference, this is the reference output pin. When using an external reference, this is the reference input pin. The default for this pin is as a reference output.
16	V _{OUTB}	Analog Output Voltage from DAC B. The output amplifier has rail-to-rail operation.
17	EPAD	Exposed Pad. The exposed pad must be tied to GND.

TYPICAL PERFORMANCE CHARACTERISTICS

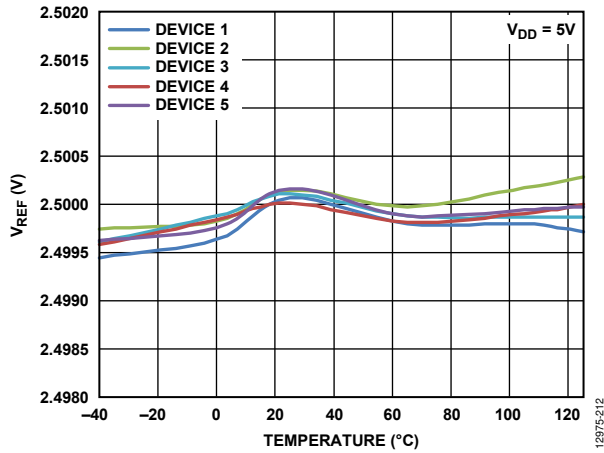

Figure 7. Internal Reference Voltage (V_{REF}) vs. Temperature

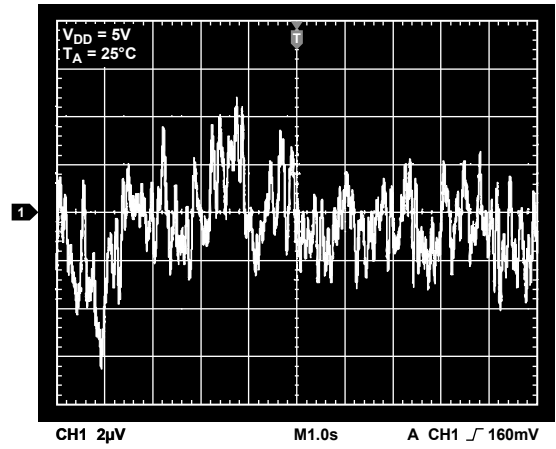

Figure 10. Internal Reference Noise, 0.1 Hz to 10 Hz

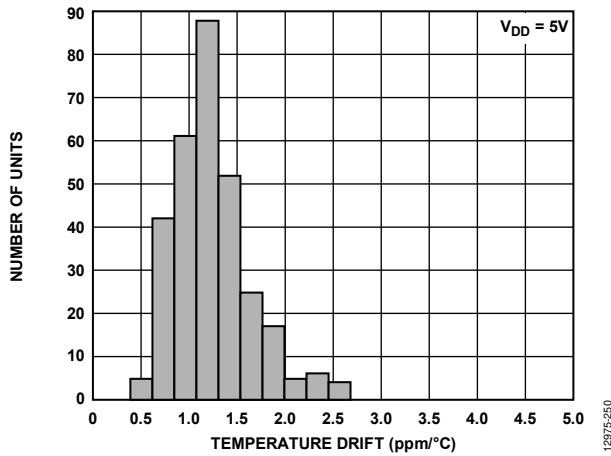

Figure 8. Reference Output Temperature Drift Histogram

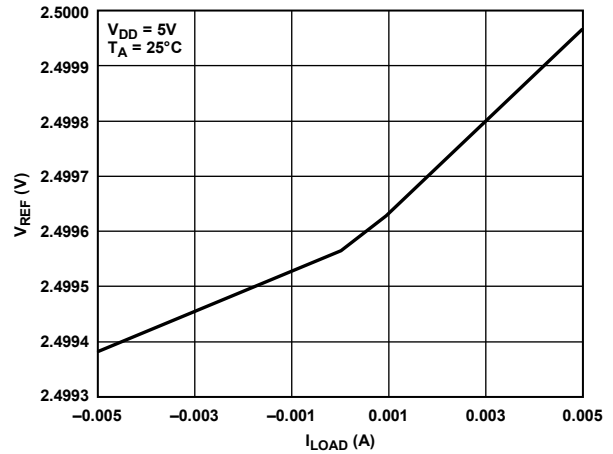

Figure 11. V_{REF} vs. Load Current (I_{LOAD})

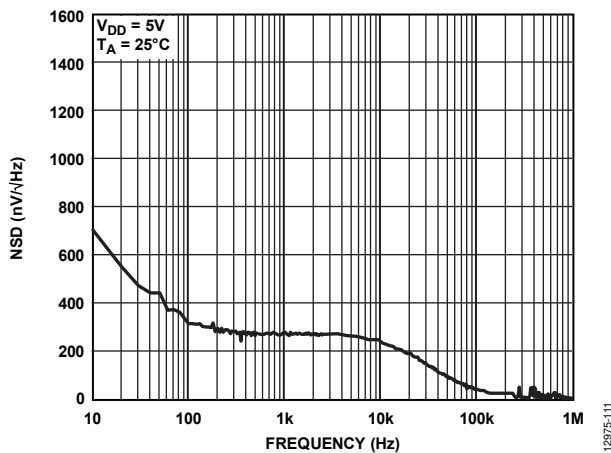

Figure 9. Internal Reference Noise Spectral Density (NSD) vs. Frequency

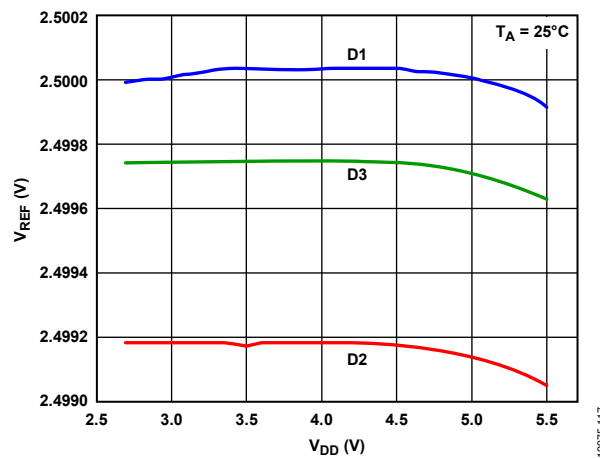

Figure 12. V_{REF} vs. Supply Voltage (V_{DD})

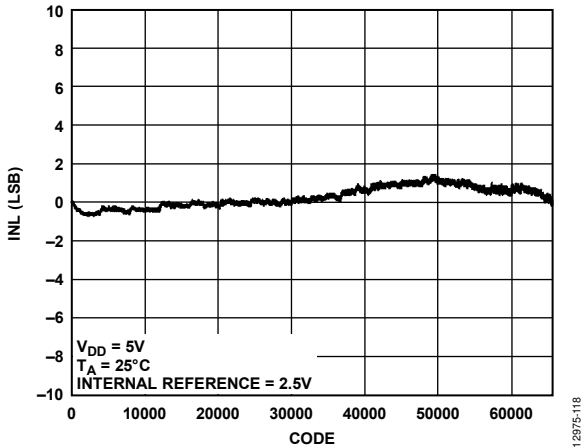

Figure 13. Integral Nonlinearity (INL) vs. Code

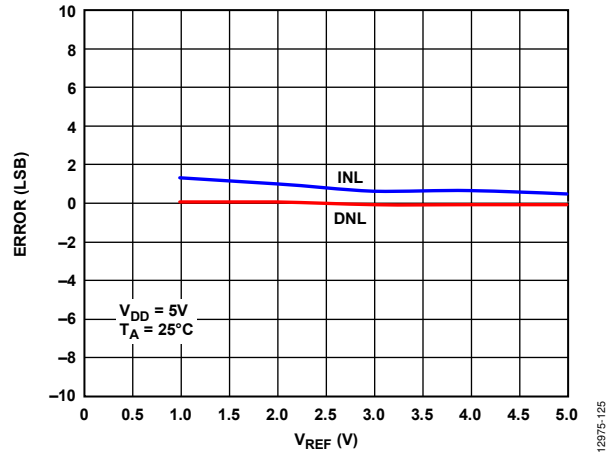

Figure 16. INL Error and DNL Error vs. V_{REF}

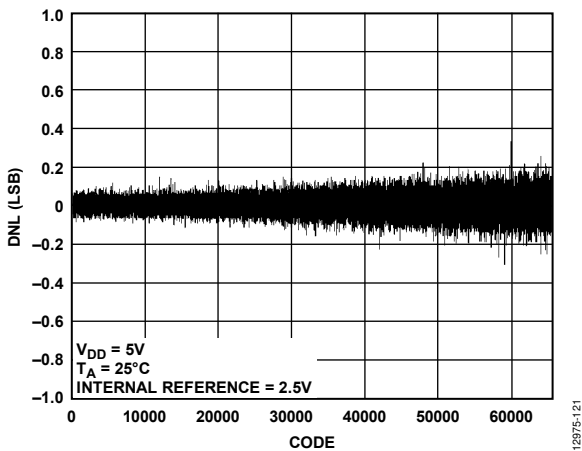

Figure 14. Differential Nonlinearity (DNL) vs. Code

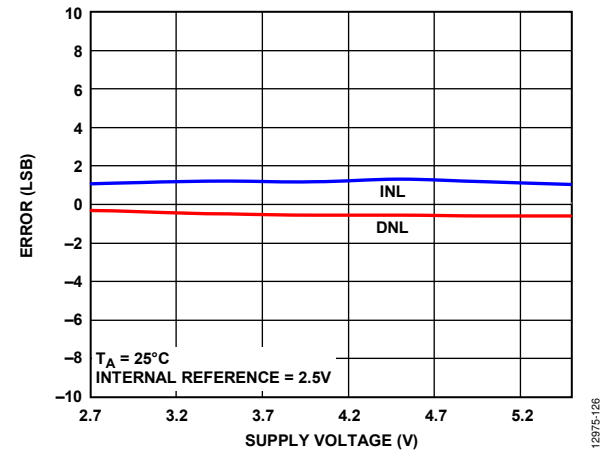

Figure 17. INL Error and DNL Error vs. Supply Voltage

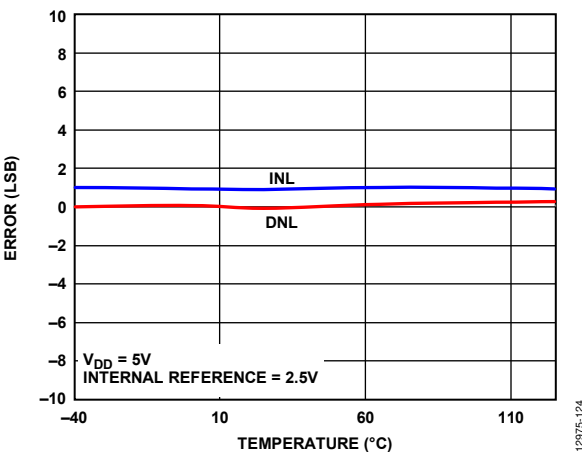

Figure 15. INL Error and DNL Error vs. Temperature

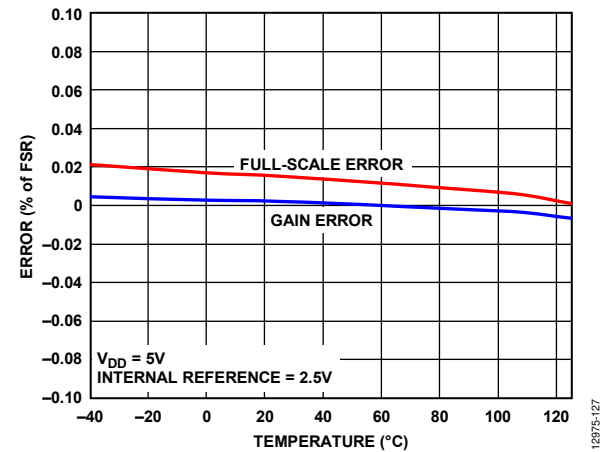

Figure 18. Gain Error and Full-Scale Error vs. Temperature

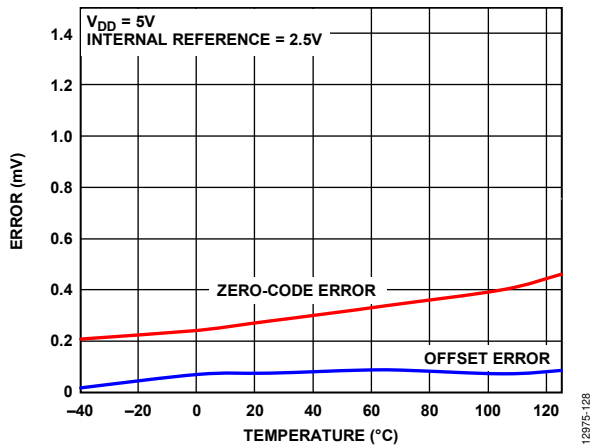

Figure 19. Zero-Code Error and Offset Error vs. Temperature

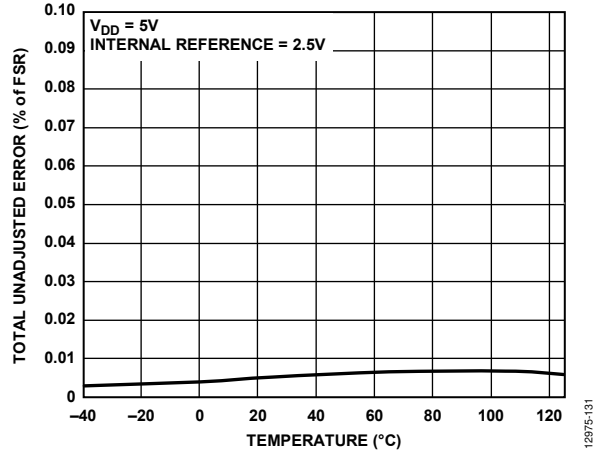

Figure 22. Total Unadjusted Error (TUE) vs. Temperature

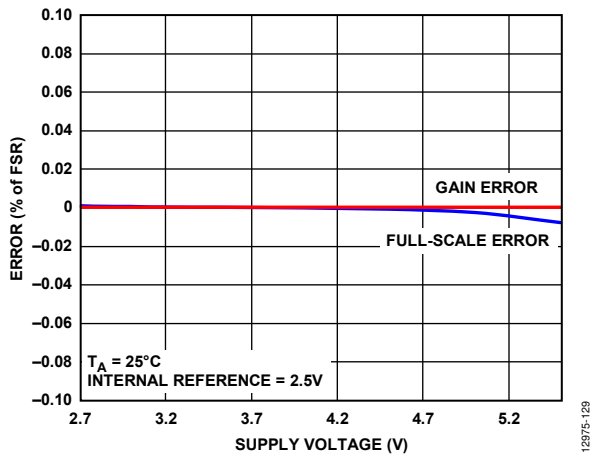

Figure 20. Gain Error and Full-Scale Error vs. Supply Voltage

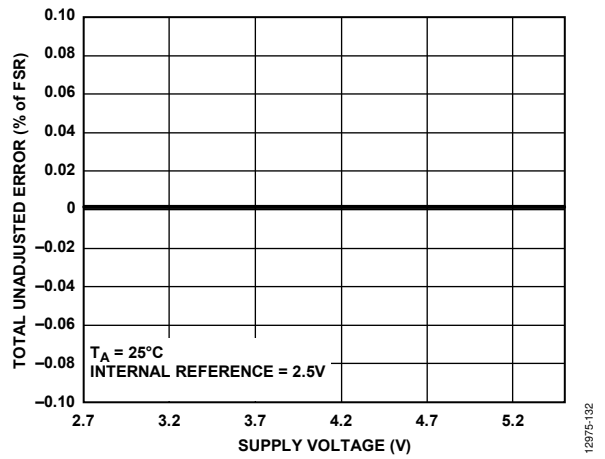

Figure 23. Total Unadjusted Error (TUE) vs. Supply Voltage, Gain = 1

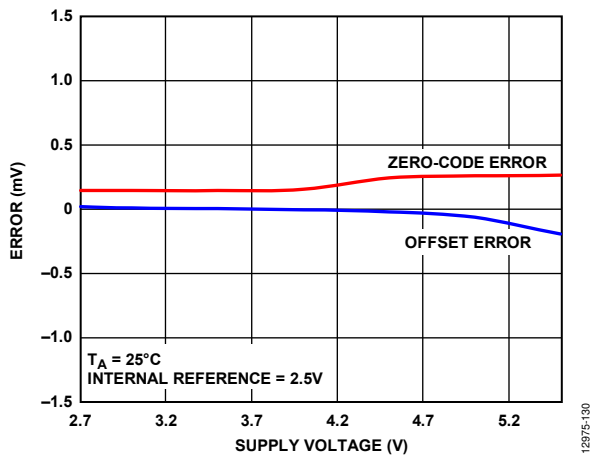

Figure 21. Zero-Code Error and Offset Error vs. Supply Voltage

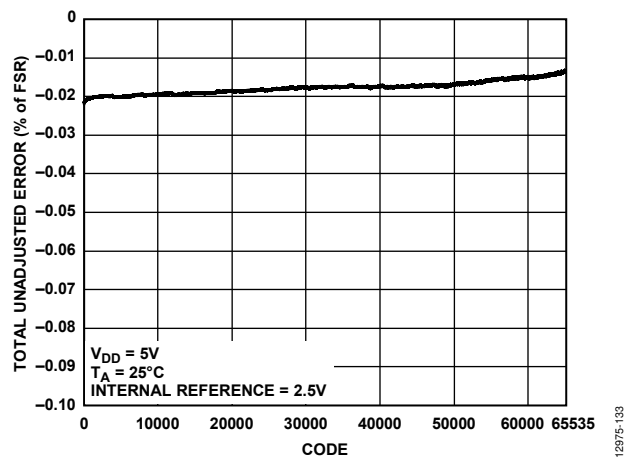

Figure 24. Total Unadjusted Error (TUE) vs. Code

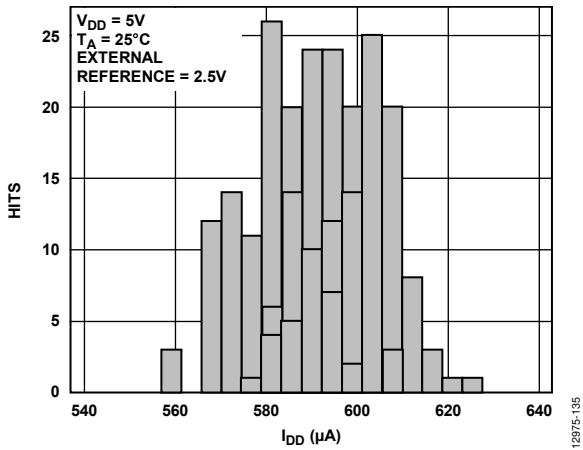

Figure 25. I_{DD} Histogram with External Reference, 5V

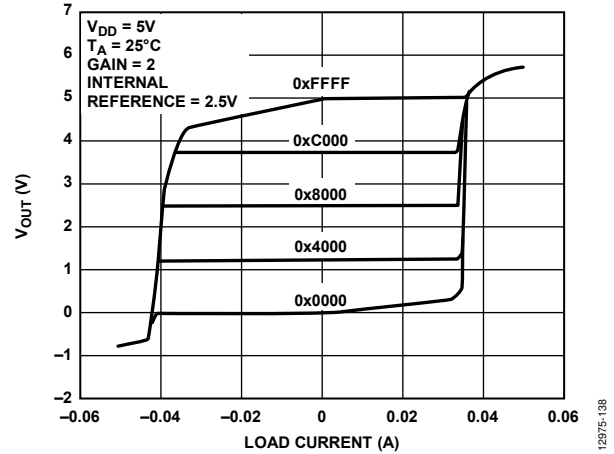

Figure 28. Source and Sink Capability at 5V

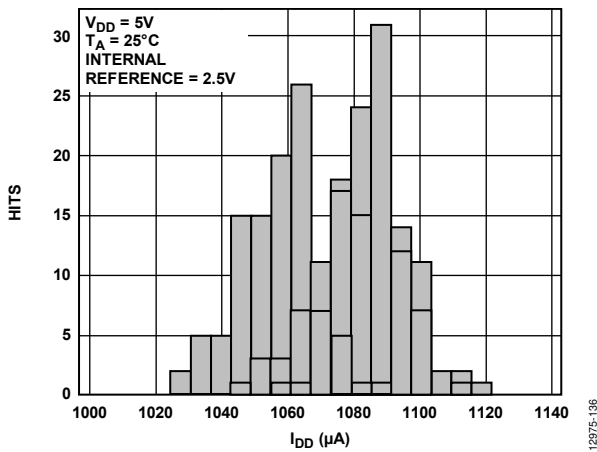

Figure 26. I_{DD} Histogram with Internal Reference, $V_{REFOUT} = 2.5V$, Gain = 2

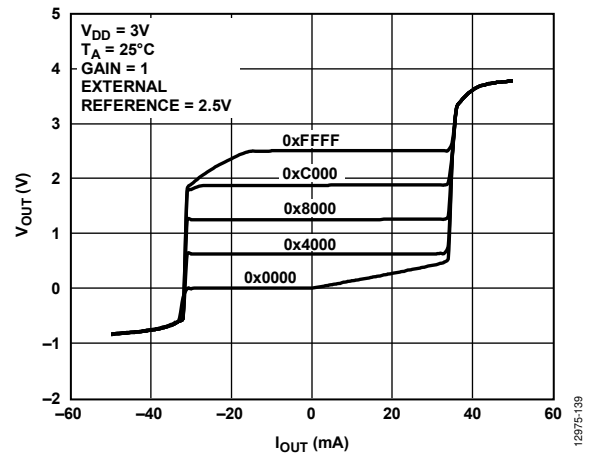

Figure 29. Source and Sink Capability at 3V

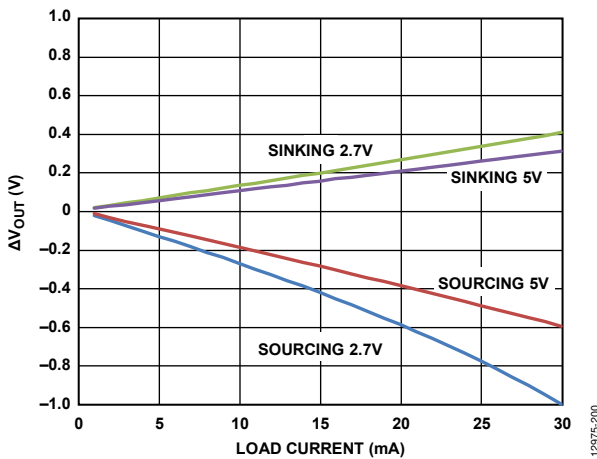

Figure 27. Headroom/Footroom vs. Load Current

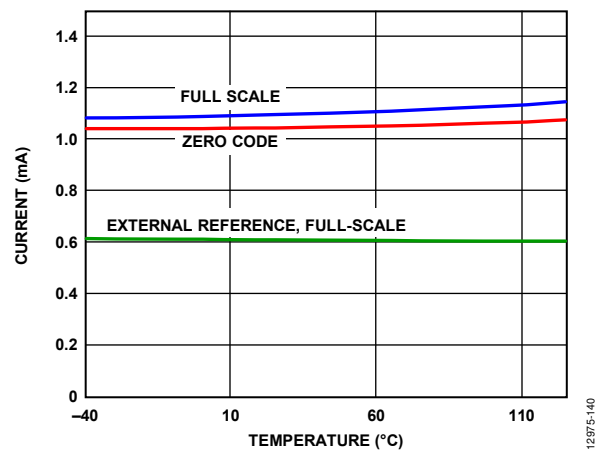

Figure 30. Supply Current vs. Temperature

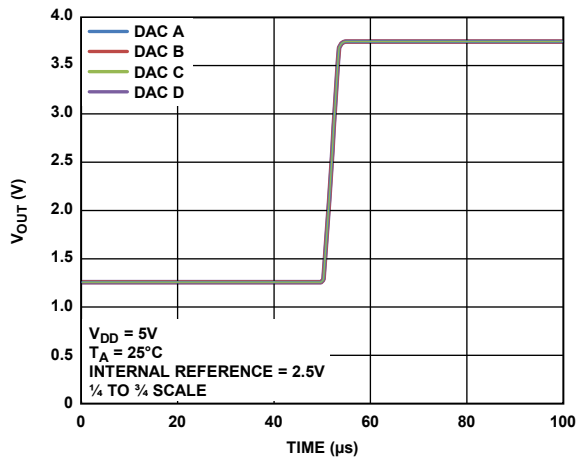

Figure 31. Settling Time

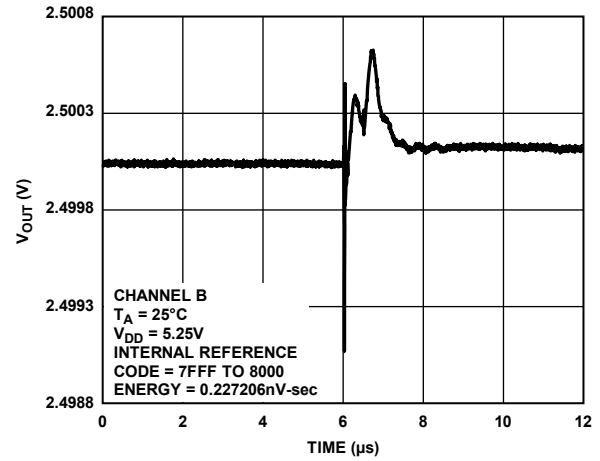

Figure 34. Digital-to-Analog Glitch Impulse

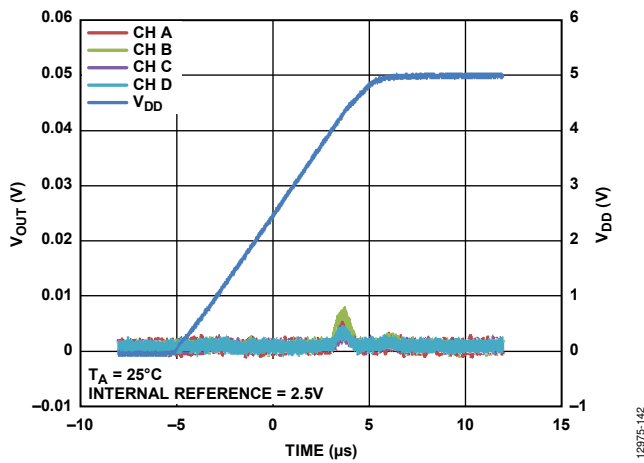

Figure 32. Power-On Reset to 0V

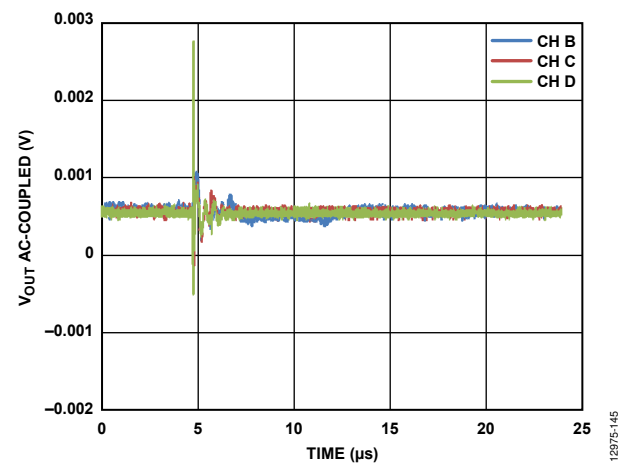

Figure 35. Analog Crosstalk, Channel A

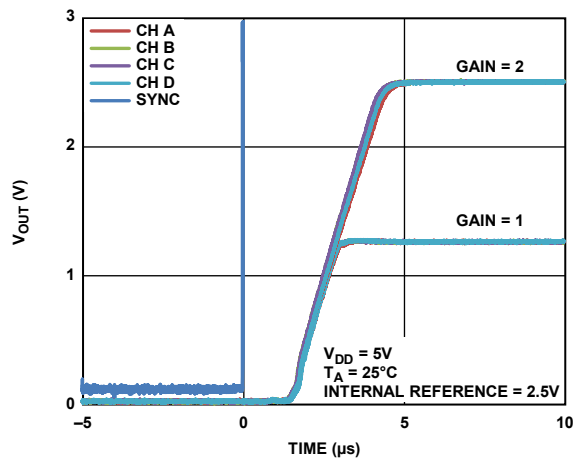

Figure 33. Exiting Power-Down to Midscale

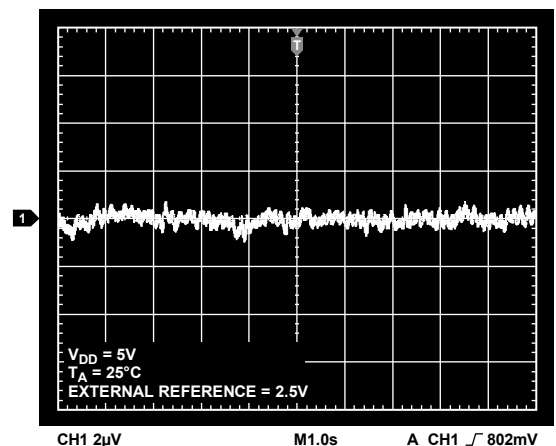

Figure 36. 0.1 Hz to 10 Hz Output Noise Plot, External Reference

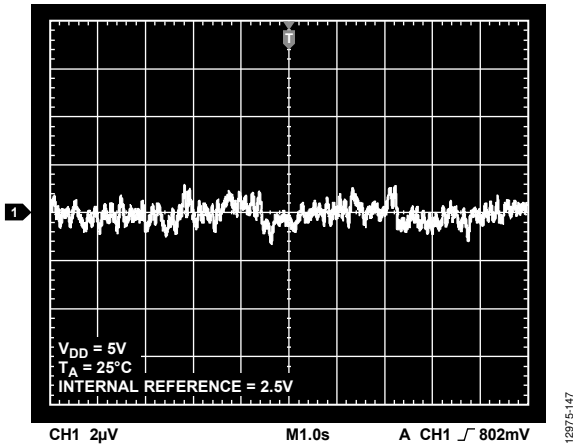

Figure 37. 0.1 Hz to 10 Hz Output Noise Plot, 2.5 V Internal Reference

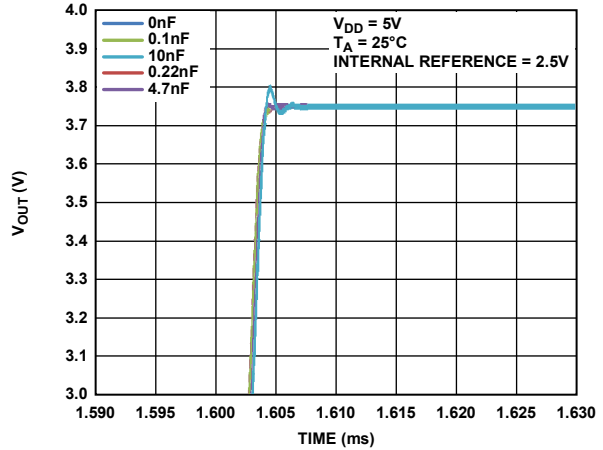

Figure 40. Settling Time for Various Capacitive Loads

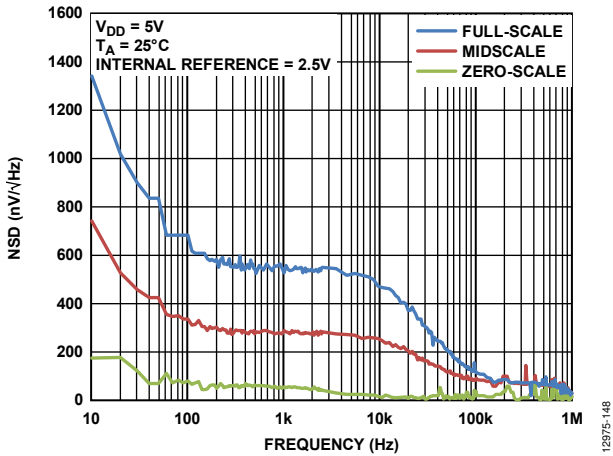

Figure 38. Noise Spectral Density (NSD)

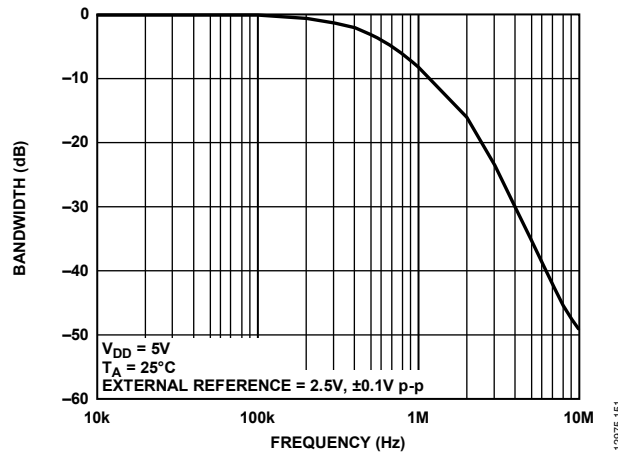

Figure 41. Multiplying Bandwidth, External Reference = 2.5 V, ±0.1 V p-p, 10 kHz to 10 MHz

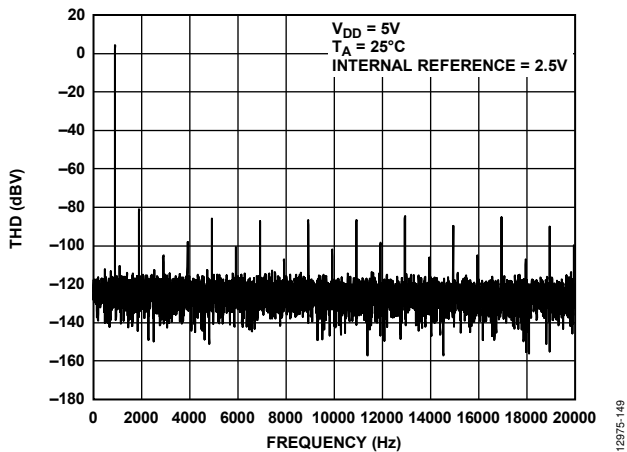
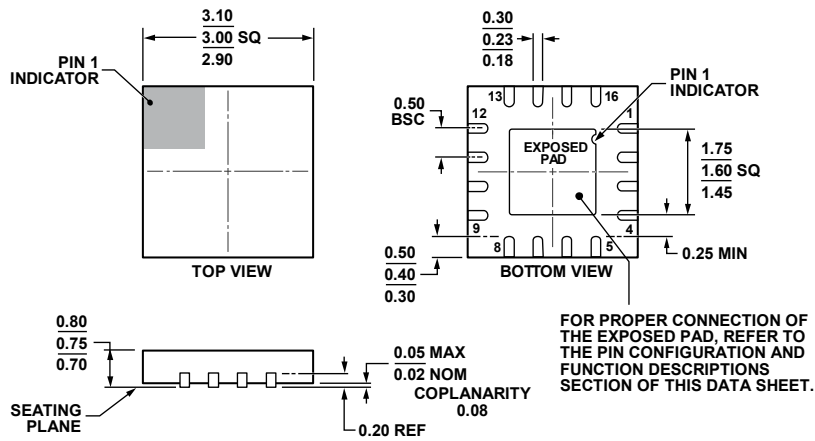

Figure 39. Total Harmonic Distortion at 1 kHz

OUTLINE DIMENSIONS



COMPLIANT TO JEDEC STANDARDS MO-220-WEED-6.

Figure 42. 16-Lead Lead Frame Chip Scale Package [LFCSP_WQ]
 3 mm × 3 mm Body, Very Very Thin Quad
 (CP-16-22)
 Dimensions shown in millimeters

08-16-2010-E

ORDERING GUIDE

Model ¹	Resolution	Temperature Range	Package Description	Package Option	Branding
AD5686RTCPZ-EP-RL7	16 Bits	-55°C to +125°C	16-Lead LFCSP_WQ	CP-16-22	DNG

¹ Z = RoHS Compliant Part.