

Series 228H

5.2 x 8.0mm Illuminated Tactile Switch

- Surface mount gull-wing terminal or standard through hole configurations
- Compatible with IR reflow, manual soldering
- Single color display during illumination
- Variety of LED color options
- Halogen Free

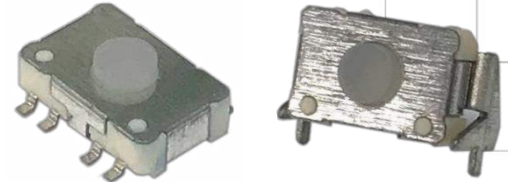

Ordering Information

Series	Terminal Type	Actuating Direction	Actuation Force	LED Color	LED Type	Packaging
228H	M	V	A	A	F	R

Code	Spec.
M	Surface mount gull wing
*D	Standard though hole

*Standard though hole is only available with side actuation

Code	Spec.
V	Vertical
*S	Side

*Side actuation is only available with standard though hole terminal

Code	Spec.
A	Amber
B	Blue
W	White
AB	Amber & Blue
AW	Amber & White
LB	Olive Green & Blue
LW	Olive Green & White
RB	Red & Blue
RL	Red & Olive Green
RG	Red & Pure Green

Code	Spec.
F	Flat

Code	Spec.
R	Tape & reel packaging

Code	Spec.
A	160 gf

Electrical Specifications

Parameter	Conditions & Remarks	Min	Max	Unit
Contact Resistance			100	milliohms
Insulation Resistance	Between insulated terminals	100		megohms
Dielectric Strength	250 VAC between adjacent switches		1	minute
Nonswitching Rating			50 or 12	mA or VDC

Mechanical and Environmental

Soldering	Maximum reflow temperature, 260°C for 3 seconds
RoHS	Lead-Free. Fully compliant to RoHS Directive 2011/65/EU
Operating Force	160±50 gf
Actuation Life	100,000 cycles
Actuator Strength	3 Kgf maximum
Travel	0.5±0.15mm
Packaging	Tape&reel packaging
Operating Temperature Range	-20°C to +70°C
Storage Temperature Range	-30°C to +80°C
MSL Level	3

LED Specifications

Color	Reversed Voltage (Max)	Reversed Current (Max)	Recommended Operating Current	Forward Voltage at 20mA		Chromaticity Coordinates	
				Nor	Max		
Red	5 Vdc	100 µA	30 mA	1.9V	2.4V	0.297	0.295
Olive Green	5 Vdc	100 µA	30 mA	1.9V	2.4V		
Yellow	5 Vdc	100 µA	30 mA	1.9V	2.4V		
Blue	5 Vdc	50 µA	30 mA	3.2V	4.0V		
				Forward Voltage at 20mA		X	Y
White	5 Vdc	50 µA	30 mA	3.0V	4.0V		

Mechanical Specifications

Figure 1 – 228HMV, Surface Mount Gull Wing , Vertical Actuation

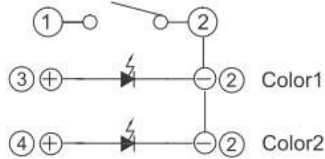
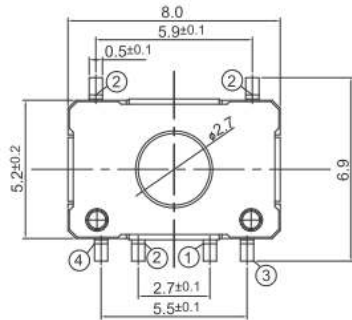

CIRCUIT DIAGRAM

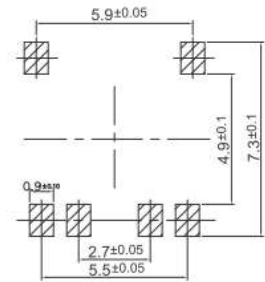

PCB LAYOUT

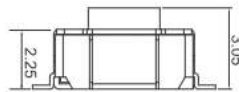
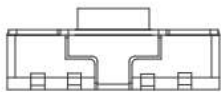

DIMENSION : mm
STANDARD TOLERANCE : ±0.3

Figure 2 – 228HDV, Standard Through Hole , Vertical Actuation

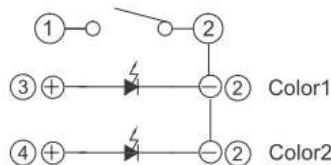
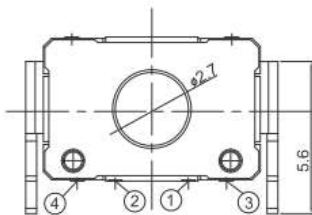

CIRCUIT DIAGRAM

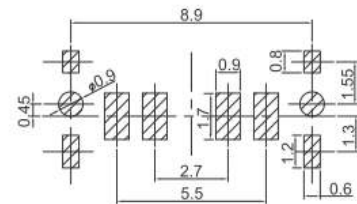

PCB LAYOUT

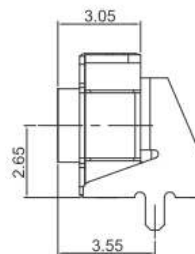
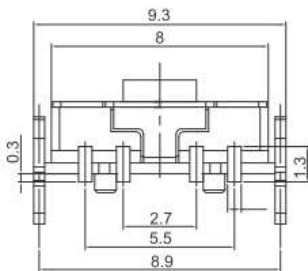

DIMENSION : mm
STANDARD TOLERANCE : ±0.3

Packing: Tape and Reel

Surface Mount Gull Wing, Actuator Height 3.05mm

The packing specifications:

1. Structure and materials:

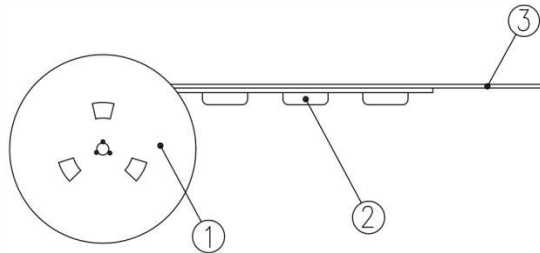

No	PART NAME	MATERIAL
①	REEL	POLYSTYRENE
②	CARRIER TAPE	POLYSTYRENE
③	COVER TAPE	POLYESTER

2. Packing quantity: 1500 pcs/reel
3. More than 160mm empty pockets should remain at each end of the carrier tape for each reel. After reel packaging, the end of tape 180mm, shall be empty and the tape edge shall be cut in 45°. The cover tape shall be extended 180±10 mm from the tape edge and fixed with tape.
4. Shortage of less than 2 pcs a reel is acceptable.
5. Stripping strength of cover tape is between 10 gf to 130 gf and stripping angle should be within 165°~180°.
6. The product in the pocket of carrier tape should be placed in a specified correct position.
7. Tape and reel per EIA-481.
8. Dimensions:

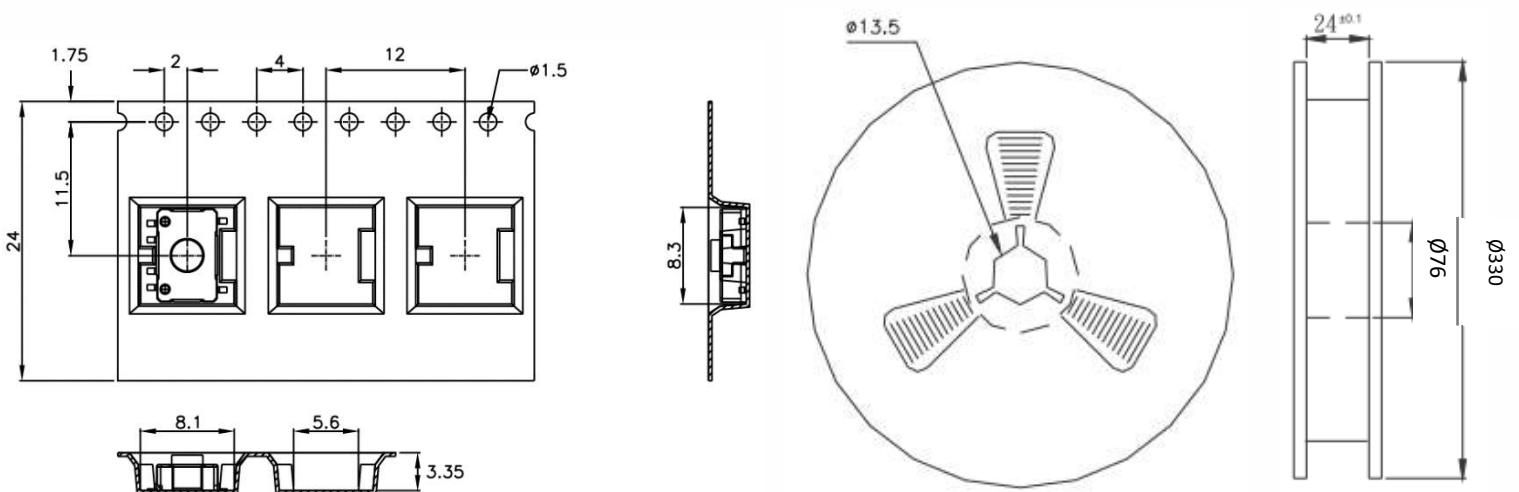

Standard Through Hole, Actuator Height 5.60mm

The packing specifications:

1. Structure and materials:

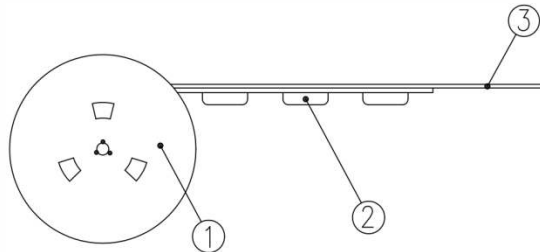

No	PART NAME	MATERIAL
①	REEL	POLYSTYRENE
②	CARRIER TAPE	POLYSTYRENE
③	COVER TAPE	POLYESTER

2. Packing quantity: 700 pcs/reel
3. More than 160mm empty pockets should remain at each end of the carrier tape for each reel. After reel packaging, the end of tape 180mm, shall be empty and the tape edge shall be cut in 45°. The cover tape shall be extended 180±10 mm from the tape edge and fixed with tape.
4. Shortage of less than 2 pcs a reel is acceptable.
5. Stripping strength of cover tape is between 10 gf to 130 gf and stripping angle should be within 165°~180°.
6. The product in the pocket of carrier tape should be placed in a specified correct position.
7. Tape and reel per EIA-481.
8. Dimensions:

