

Sound Processor Series for Car Audio

# Sound processor with Built-in 2-band Equalizer



## BD37503FV

### ● General Description

Sound processor which has built-in 4input selector and 2-band equalizer filter. And, loudness filter and 2nd-order anti-aliasing filter which attenuate noise occurs at output of DAC are available, either one by switching.

### ● Features

- Built-in differential input selector that can make various combination of single-ended / differential input.
- Reduce switching noise by using advanced switch circuit
- Built-in ground isolation amplifier inputs, ideal for external stereo input.
- Decrease the number of external components by built-in 2nd-order anti-aliasing filter
- Decrease the number of external components by built-in 2-band equalizer filter and loudness filter.
- A PCB area can be reduced and PCB layouts become easy thanks to that signal flow is gathered to one direction by arrangement of input and output left side and right side separately.
- It is possible to control by 3.3V / 5V for I<sup>2</sup>C BUS serial controller.

### ● Key Specifications

- Total harmonic distortion : 0.001%(Typ.)
- Maximum input voltage : 2.2Vrms(Typ.)
- Common mode rejection ratio : 50dB(Min.)
- Maximum output voltage : 2.1Vrms(Typ.)
- Output noise voltage : 5.8 μVrms(Typ.)
- Residual output noise voltage : 2.8 μVrms (Typ.)
- Ripple rejection: -70dB (Typ.)
- Operating temperature range -40°C to +85°C

### ● Package

SSOP-B20

W(Typ.) x D(Typ.) x H(Max.)  
6.50mm x 6.40mm x 1.45mm



SSOP-B20

### ● Applications

- It is the optimal for the car audio. Besides, it is possible to use for the audio equipment of mini Compo, micro Compo, TV etc with all kinds.

### ● Typical Application Circuit

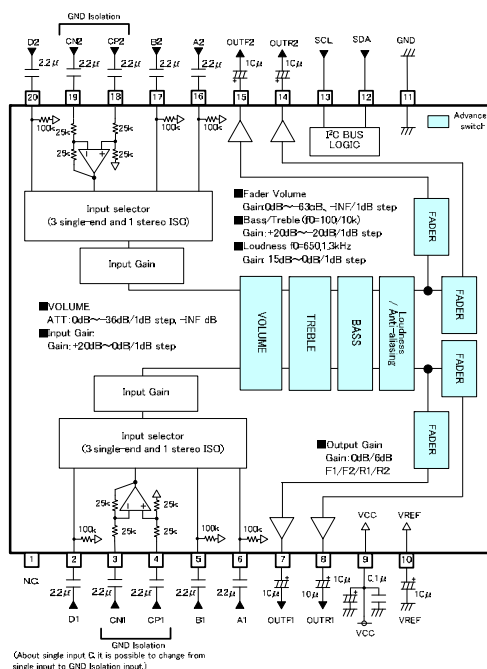

Figure 1. Application Circuit Diagram

○Product structure : Silicon monolithic integrated circuit ○This product is not designed protection against radioactive rays

www.rohm.co.jp

© 2012 ROHM Co., Ltd. All rights reserved.

TS222111 · 14 · 001

● Pin Configuration

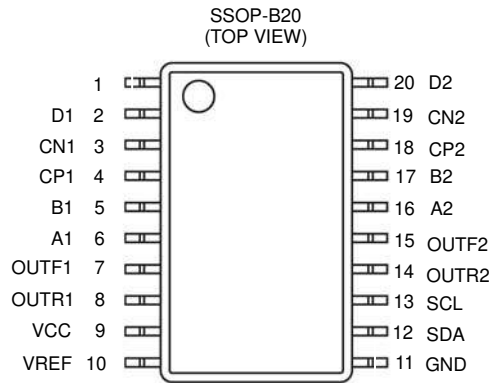

Figure 2. Pin configuration

● Pin Description

Terminal No.	Symbol	Description of terminals	Terminal No.	Symbol	Description of terminals
1	N.C.	Non connection terminal	11	GND	GND terminal
2	D1	D input terminal of 1ch	12	SDA	I <sup>2</sup> C Communication data terminal
3	CN1	C negative input terminal of 1ch	13	SCL	I <sup>2</sup> C Communication clock terminal
4	CP1	C positive input terminal of 1ch	14	OUTR2	Rear output terminal of 2ch
5	B1	B input terminal of 1ch	15	OUTF2	Front output terminal of 2ch
6	A1	A input terminal of 1ch	16	A2	A input terminal of 2ch
7	OUTF1	Front output terminal of 1ch	17	B2	B input terminal of 2ch
8	OUTR1	Rear output terminal of 1ch	18	CP2	C positive input terminal of 2ch
9	VCC	Power supply terminal	19	CN2	C negative input terminal of 2ch
10	VREF	BIAS terminal	20	D2	D input terminal of 2ch

● Block Diagram

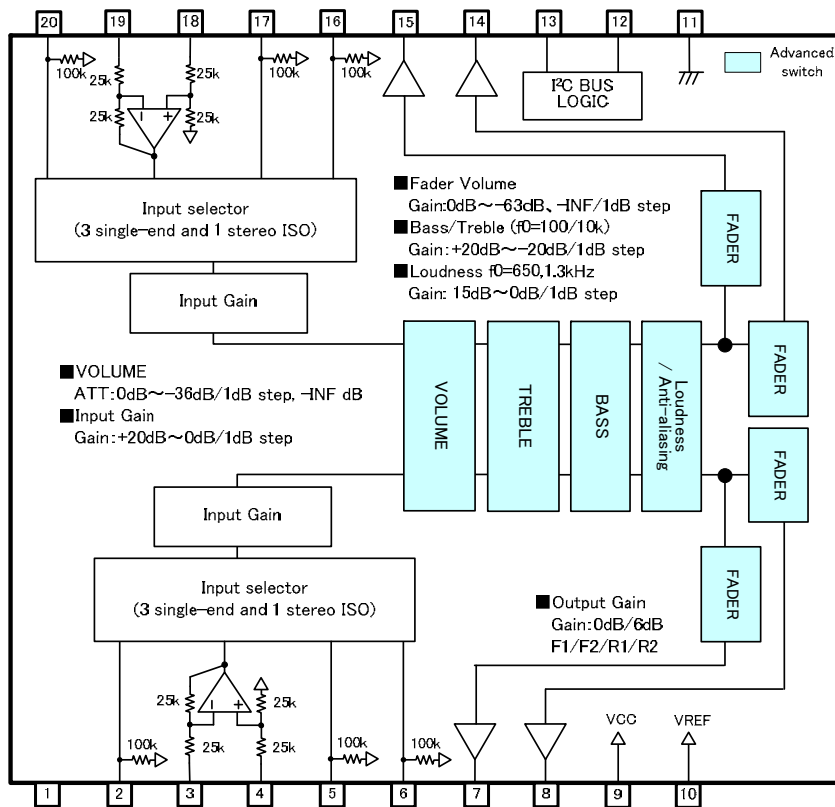

Figure 3. Block Diagram

● Absolute Maximum Ratings (Ta=25°C)

Item	Symbol	Rating	Unit
Power supply Voltage	VCC	10.0	V
Input voltage	Vin	VCC+0.3 to GND-0.3 SCL,SDA : 7 to GND-0.3	V
Power Dissipation	Pd	937 ※1	mW
Storage Temperature	Tastg	-55 to +150	°C

※1 This value decreases 7.5mW/°C for Ta=25°C or more.

ROHM standard board shall be mounted. Thermal resistance  $\theta_{ja} = 133.3(^{\circ}\text{C}/\text{W})$   
 ROHM Standard board size : 70×70×1.6(mm)

material : FR4 A FR4 glass epoxy board(3% or less of copper foil area)

● Recommended Operating Rating

Item	Symbol	MIN.	TYP.	MAX.	Unit
Power supply Voltage	VCC	7.0	8.5	9.5	V
Temperature	Topr	-40	-	+85	°C

## ●Electrical Characteristic

Unless specified particularly, Ta=25°C, VCC=8.5V, f=1kHz, Vin=1Vrms, Rg=600Ω, RL=10kΩ, A input, Input gain 0dB, Volume 0dB, Tone control 0dB, Loudness 0dB, Fader 0dB, Output Gain 0dB

BLOCK	Item	Symbol	Limit			Unit	Condition
			MIN.	TYP.	MAX.		
GENERAL	Current upon no signal	I <sub>Q</sub>	—	20	27	mA	No signal
	Voltage gain	G <sub>V</sub>	-1.5	0	1.5	dB	G <sub>V</sub> =20log(VOUT/VIN)
	Channel balance	CB	-1.5	0	1.5	dB	CB = G <sub>V1</sub> -G <sub>V2</sub>
	Total harmonic distortion	THD+N1	—	0.001	0.05	%	VOUT=1Vrms BW=400-30KHz
	Output noise voltage *	V <sub>NO</sub>	—	5.8	18	μVrms	Rg = 0Ω BW = IHF-A
	Residual output noise voltage *	V <sub>NOR</sub>	—	2.8	9	μVrms	Fader = -∞dB Rg = 0Ω BW = IHF-A
	Cross-talk between channels *	CTC	—	-100	-90	dB	Rg = 0Ω CTC=20log(VOUT/VIN) BW = IHF-A
	Ripple rejection	RR	—	-70	-40	dB	f=1kHz VRR=100mVrms RR=20log(VCC IN/VOUT)
INPUT SELECTOR	Input impedance(A, B, D)	R <sub>IN S</sub>	70	100	130	kΩ	
	Input impedance(CP,CN)	R <sub>IN D</sub>	35	50	65	kΩ	
	Maximum input voltage	V <sub>IM</sub>	2	2.2	—	Vrms	V <sub>IM</sub> at THD+N(VOUT)=1% BW=400-30KHz
	Cross-talk between selectors *	CTS	—	-100	-90	dB	Rg = 0Ω CTS=20log(VOUT/VIN) BW = IHF-A
	Common mode rejection ratio	CMRR	50	60	—	dB	CP1 and CN1 input CP2 and CN2 input CMRR=20log(VIN/VOUT) BW = IHF-A,
INPUT GAIN	Minimum input gain	G <sub>IN MIN</sub>	-2	0	2	dB	Input gain 0dB VIN=100mVrms G <sub>IN</sub> =20log(VOUT/VIN)
	Maximum input gain	G <sub>IN MAX</sub>	18	20	22	dB	Input gain 20dB VIN=100mVrms G <sub>IN</sub> =20log(VOUT/VIN)
	Gain set error	G <sub>IN ERR</sub>	-2	0	2	dB	GAIN=+1 to +20dB

BLOCK	Item	Symbol	Limit			Unit	Condition
			MIN.	TYP.	MAX.		
VOLUME	Maximum gain	$G_{V\ MAX}$	-1.5	0	1.5	dB	Volume = 0dB VIN=100mVrms $G_V=20\log(V_{OUT}/V_{IN})$
	Maximum attenuation *	$G_{V\ MIN}$	—	-100	-85	dB	Volume = $-\infty$ dB $G_V=20\log(V_{OUT}/V_{IN})$ BW = IHF-A
	Attenuation set error	$G_{V\ ERR1}$	-2	0	2	dB	ATT=0dB to -36dB
BASS	Maximum boost gain	$G_{B\ BST}$	18	20	22	dB	Gain=+20dB f=100Hz VIN=100mVrms $G_B=20\log(V_{OUT}/V_{IN})$
	Maximum cut gain	$G_{B\ CUT}$	-22	-20	-18	dB	Gain=-20dB f=100Hz VIN=2Vrms $G_B=20\log(V_{OUT}/V_{IN})$
	Gain set error	$G_{B\ ERR}$	-2	0	2	dB	Gain=+20 to -20dB f=100Hz
TREBLE	Maximum boost gain	$G_{T\ BST}$	18	20	22	dB	Gain=+20dB f=10kHz VIN=100mVrms $G_T=20\log(V_{OUT}/V_{IN})$
	Maximum cut gain	$G_{T\ CUT}$	-22	-20	-18	dB	Gain=-20dB f=10kHz VIN=2Vrms $G_T=20\log(V_{OUT}/V_{IN})$
	Gain set error	$G_{T\ ERR}$	-2	0	2	dB	Gain=+20 to -20dB f=10kHz
FADER	Maximum gain	$G_{F\ BST}$	-2	0	2	dB	Gain=0dB $G_F=20\log(V_{OUT}/V_{IN})$
	Maximum attenuation *	$G_{F\ MIN}$	—	-100	-90	dB	Fader = $-\infty$ dB $G_F=20\log(V_{OUT}/V_{IN})$ BW = IHF-A
	Attenuation set error 1	$G_{F\ ERR1}$	-2	0	2	dB	ATT=-1 to -15dB
	Attenuation set error 2	$G_{F\ ERR2}$	-3	0	3	dB	ATT=-16 to -47dB
	Attenuation set error 3	$G_{F\ ERR3}$	-4	0	4	dB	ATT=-48 to -63dB
	Output impedance	$R_{O\ FAD}$	-	—	50	$\Omega$	VIN=100mVrms
LOUDNESS	Maximum output voltage	$V_{OM\ F}$	2	2.1	—	Vrms	THD+N=1% BW=400-30KHz
	Maximum gain	$G_{LD\ MAX}$	13	15	17	dB	Gain=15dB $G_{LD}=20\log(V_{OUT}/V_{IN})$ BW=IHF-A
	Gain set error	$G_{LD\ ERR}$	-2	0	2	dB	Gain=0dB to -15dB $G_{LD}=20\log(V_{OUT}/V_{IN})$
OUTPUT GAIN	Maximum gain	$G_{OUT\ MAX}$	4	6	8	dB	Gain +6dB VIN=100mVrms $G_{OUT}=20\log(V_{OUT}/V_{IN})$
	Gain set error	$G_{OUT\ ERR}$	-2	0	2	dB	Gain=0dB, +6dB

※VP-9690A(Average value detection, effective value display) filter by Matsushita Communication is used for \* measurement.

※Phase between input / output is same.

● Typical Performance Curve(reference data)

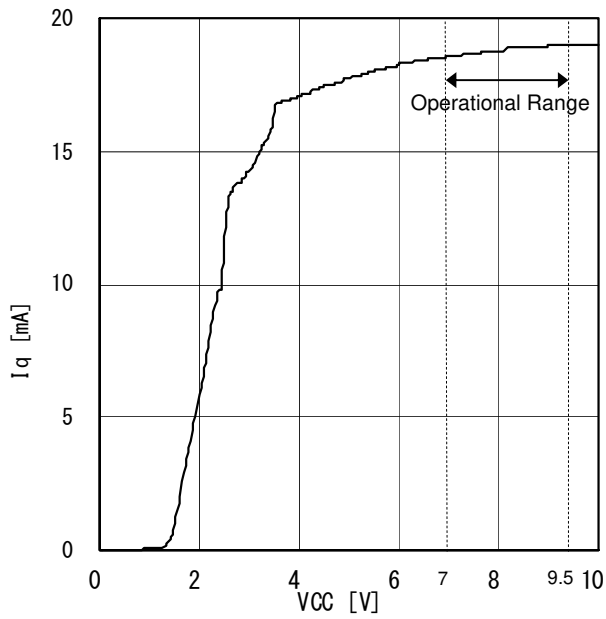

Figure 4. Iq vs VCC

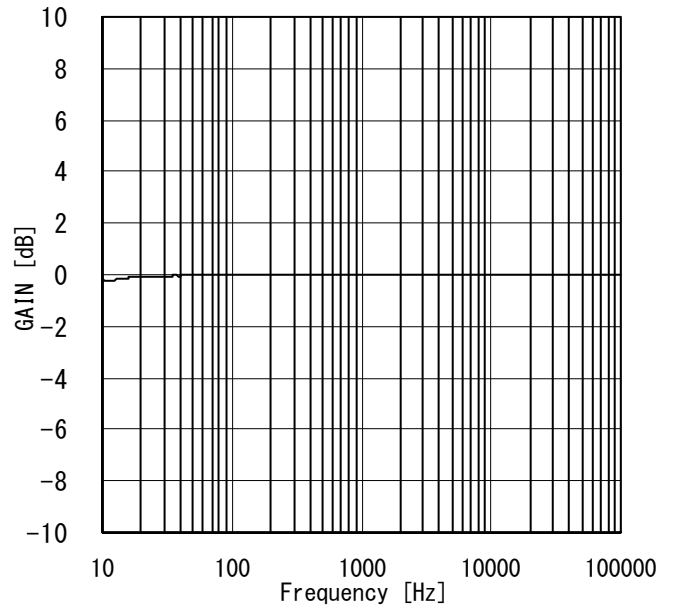

Figure 5. Gain vs Frequency

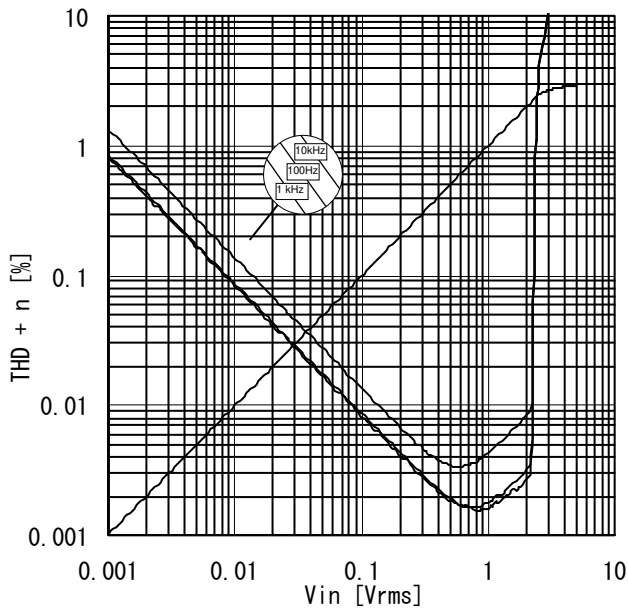

Figure 6. THD+n vs Input Voltage

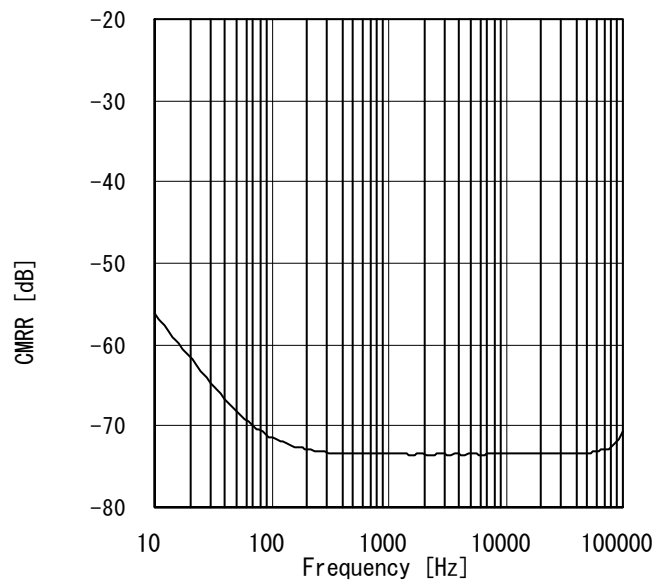

Figure 7. CMRR vs Frequency

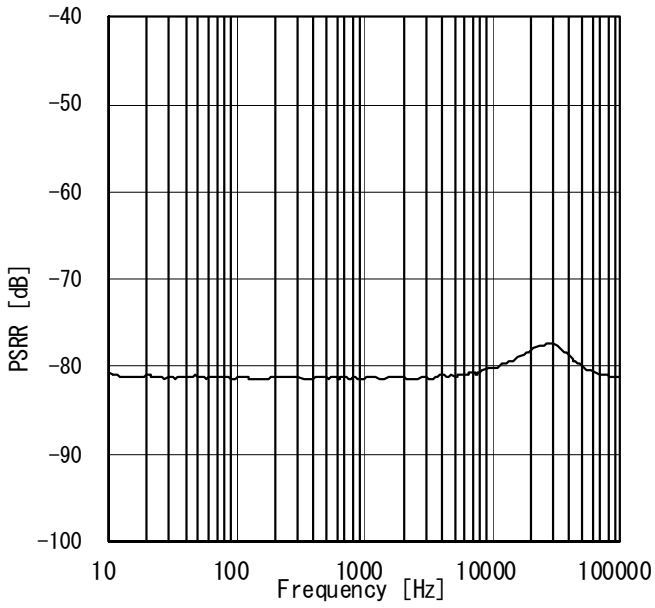

Figure 8. PSRR vs Frequency

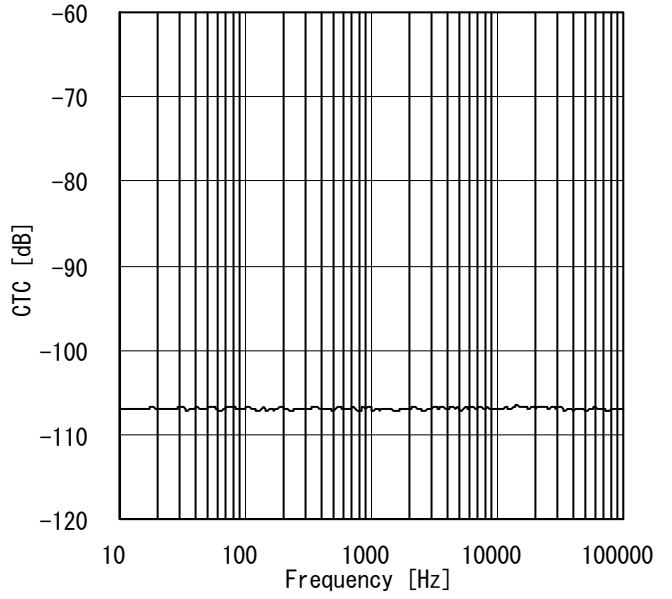

Figure 9. Cross-talk between channels vs Frequency

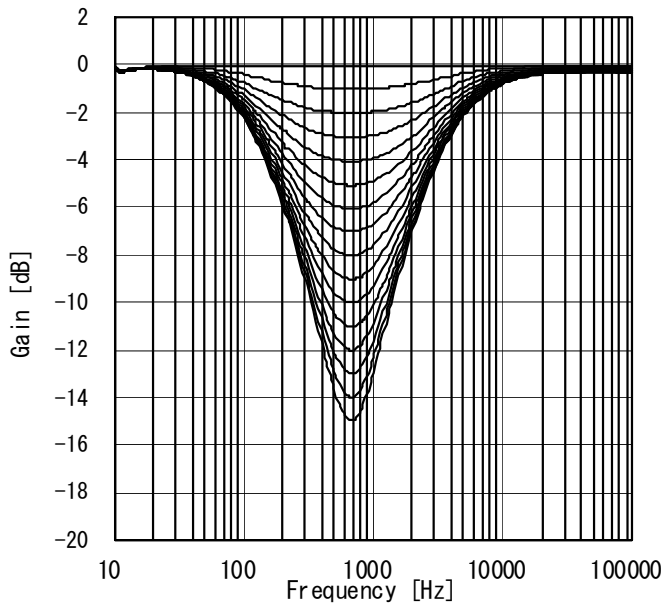

Figure 10. Loudness Gain vs Frequency

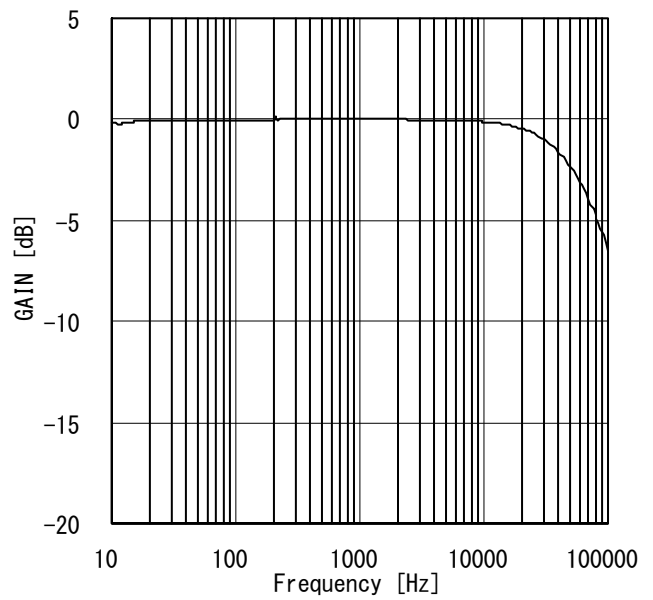

Figure 11. Antifilter Gain vs Frequency

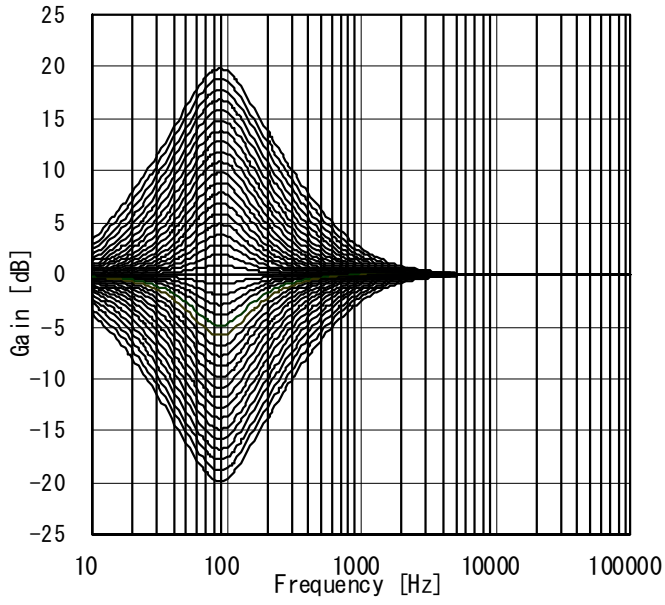

Figure 12. Bass Gain vs Frequency

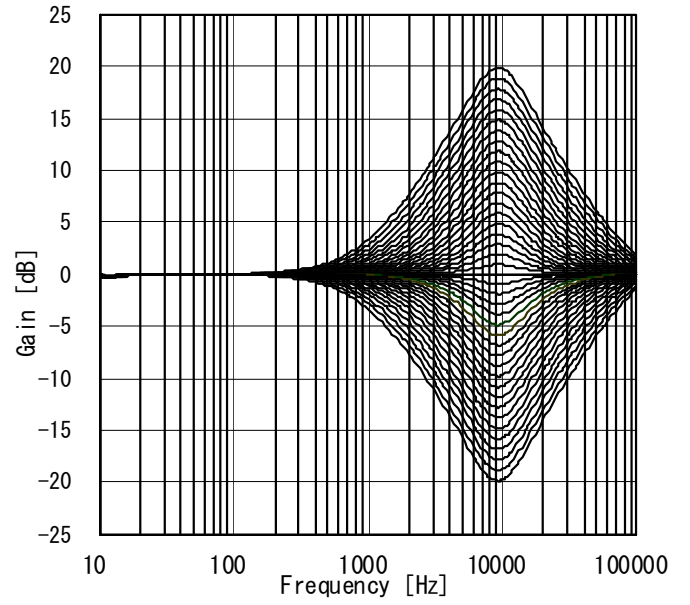

Figure 13. Treble Gain vs Frequency



●CONTROL SIGNAL SPECIFICATION

(1) Electrical specifications and timing for bus lines and I/O stages

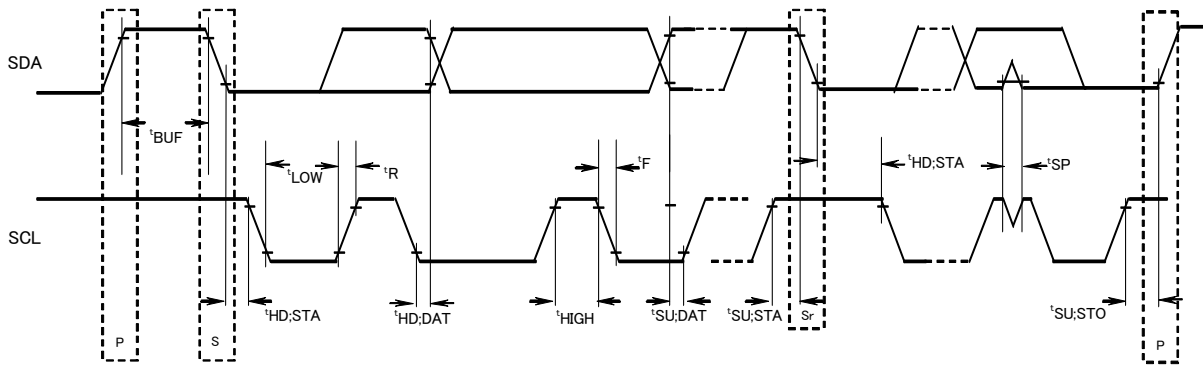

Figure 14. Definition of timing on the I<sup>2</sup>C-bus

Table 1 Characteristics of the SDA and SCL bus lines for I<sup>2</sup>C-bus devices

Parameter	Symbol	Fast-mode I <sup>2</sup> C-bus		Unit
		MIN.	MAX.	
1 SCL clock frequency	fSCL	0	400	kHz
2 Bus free time between a STOP and START condition	tBUF	1.3	—	μS
3 Hold time (repeated) START condition. After this period, the first clock pulse is generated	tHD;STA	0.6	—	μS
4 LOW period of the SCL clock	tLOW	1.3	—	μS
5 HIGH period of the SCL clock	tHIGH	0.6	—	μS
6 Set-up time for a repeated START condition	tSU;STA	0.6	—	μS
7 Data hold time	tHD;DAT	0	—	μS
8 Data set-up time	tSU; DAT	100	—	ns
9 Set-up time for STOP condition	tSU;STO	0.6	—	μS

All values referred to VIH min. and VIL max. Levels (see Table 2).  
 About 7(tHD;DAT), 8(tSU;DAT), please make setup which has enough margin.

Table 2 Characteristics of the SDA and SCL I/O stages for I<sup>2</sup>C-bus devices

Item	Symbol	Fast-mode I <sup>2</sup> C-bus		Unit
		MIN.	MAX.	
10 LOW level input voltage: In case an input level is fixed	VIL	-0.5	1	V
11 HIGH level input voltage: In case an input level is fixed	VIH	2.3	-	V
12 Pulse width of spikes which must be suppressed by the input filter.	tSP	0	50	ns
13 LOW level output voltage(open drain or open collector): at 3mA sink current	VOL1	0	0.4	V
14 Input current each I/O pin with an input voltage between 0.4V and 0.9V.	li	-10	10	μA

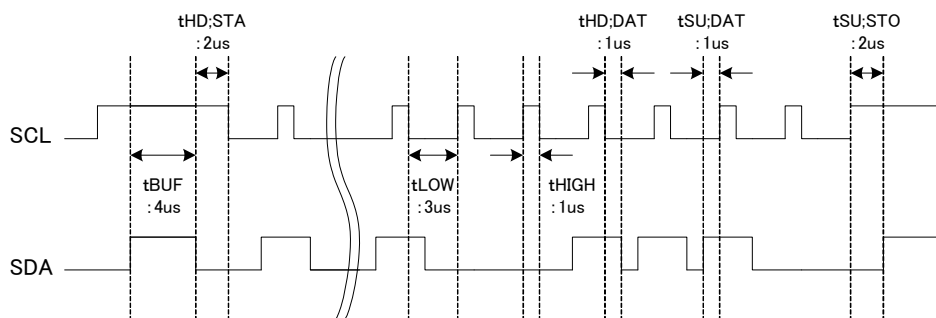

SCL clock frequency: 250kHz  
 Figure 15. A command timing example in the I<sup>2</sup>C data transmission

(2) I<sup>2</sup>C BUS FORMAT

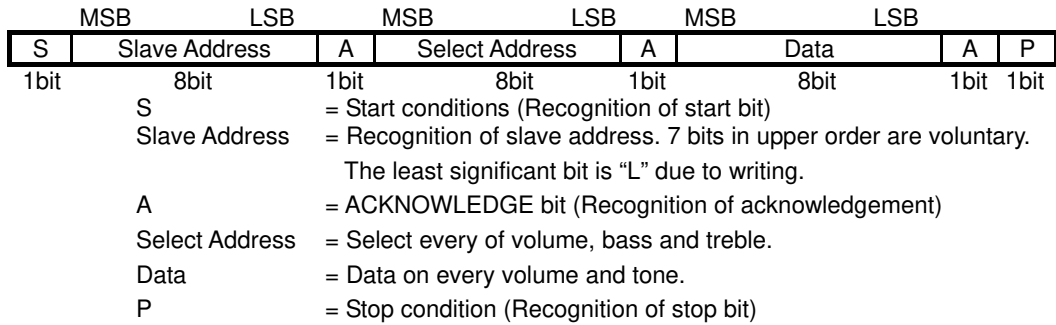

(3) I<sup>2</sup>C BUS Interface Protocol

1) Basic form

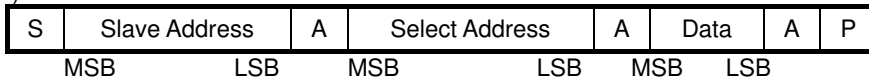

2) Automatic increment (Select Address increases (+1) according to the number of data.)

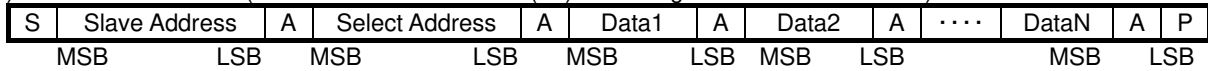

- (Example) ① Data1 shall be set as data of address specified by Select Address.  
 ② Data2 shall be set as data of address specified by Select Address +1.  
 ③ DataN shall be set as data of address specified by Select Address +N-1.

3) Configuration unavailable for transmission (In this case, only Select Address1 is set.)

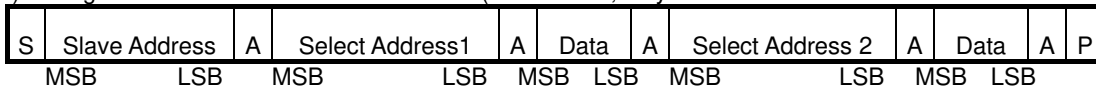

(Note) If any data is transmitted as Select Address 2 next to data, it is recognized as data, not as Select Address 2.

(4) Slave address

	MSB						LSB	
A6	A5	A4	A3	A2	A1	A0	R/W	
1	0	0	0	0	0	0	0	80H

(5) Select Address & Data

Items	Select Address (hex)	MSB	Data						LSB
		D7	D6	D5	D4	D3	D2	D1	D0
Initial setup 1	01	1	0	1	0	0	0	0	0
Initial setup 2	03	Output Gain	0	0	0	Loudness select	0	0	Loudness fo
Input selector	05	0	0	0	0	0	Input selector		
Input gain	06	0	0	0	Input Gain				
Volume gain	20	Volume Attenuation							
Fader 1ch Front	28	Fader Attenuation F1							
Fader 2ch Front	29	Fader Attenuation F2							
Fader 1ch Rear	2A	Fader Attenuation R1							
Fader 2ch Rear	2B	Fader Attenuation R2							
Bass gain	51	Bass Boost/Cut	0	0	Bass Gain				
Treble gain	57	Treble Boost/Cut	0	0	Treble Gain				
Loudness Gain	75	0	0	0	0	Loudness Gain			
System Reset	FE	1	0	0	0	0	0	0	1

 Advanced switch

Note

1. In function changing of the hatching part, it works Advanced switch.
2. Upon continuous data transfer, the Select Address is circulated by the automatic increment function, as shown below.

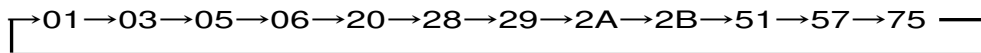

3. For the function of input selector, input gain and output gain etc, it is not corresponded for advanced switch. Therefore, please apply mute on the side of a set when changes these setting.

Select address 03(hex)

fo	MSB	Loudness fo						LSB
	D7	D6	D5	D4	D3	D2	D1	D0
650 Hz	Output Gain	0	0	0	Loudness select	0	0	0
1.3k Hz								1

Mode	MSB	Loudness select						LSB
	D7	D6	D5	D4	D3	D2	D1	D0
Loudness	Output Gain	0	0	0	0	0	0	Loudness fo
Anti-aliasing filter								

Gain	MSB	Output Gain						LSB
	D7	D6	D5	D4	D3	D2	D1	D0
0dB	0	0	0	0	Loudness select	0	0	Loudness fo
+6dB	1							

Select address 05(hex)

Mode	MSB	Input Selector						LSB
	D7	D6	D5	D4	D3	D2	D1	D0
A single	0	0	0	0	0	0	0	0
B single						0	0	1
C single						0	1	0
D single						0	1	1
C diff						1	0	0
Input SHORT						1	0	1
Prohibition						0	1	1
						1	1	1

Input SHORT : The input impedance of each input terminal is lowered from 100kΩ(TYP) to 1 kΩ(TYP).(For quick charge of coupling capacitor)

: Initial condition

The list of terminals that is active when each mode of input selector is selected

Mode	1ch+Input Terminal	1ch-Input Terminal	2ch+Input Terminal	2ch-Input Terminal
A single	6pin(A1)	-	16pin(A2)	-
B single	5pin(B1)	-	17pin(B2)	-
C single	4pin(CP1)	-	18pin(CP2)	-
D single	2pin(D1)	-	20pin(D2)	-
C diff	4pin(CP1)	3pin(CN1)	18pin(CP2)	19pin(CN2)

Select address 06 (hex)

Gain	MSB	Input Gain						LSB			
	D7	D6	D5	D4	D3	D2	D1	D0			
0dB	0	0	0	0	0	0	0	0			
1dB				0	0	0	0	1			
2dB				0	0	0	0	1	0		
3dB				0	0	0	0	1	1		
4dB				0	0	0	0	1	0	0	
5dB				0	0	0	0	1	0	1	
6dB				0	0	0	0	1	1	0	
7dB				0	0	0	0	1	1	1	
8dB				0	0	0	1	0	0	0	
9dB				0	0	0	1	0	0	1	
10dB				0	0	0	1	0	1	0	
11dB				0	0	0	1	0	1	1	
12dB				0	0	0	1	1	0	0	
13dB				0	0	0	1	1	1	0	1
14dB				0	0	0	1	1	1	1	0
15dB				0	0	0	1	1	1	1	1
16dB				0	0	0	1	0	0	0	0
17dB				0	0	0	1	0	0	0	1
18dB				0	0	0	1	0	0	1	0
19dB				0	0	0	1	0	0	1	1
20dB	0	0	0	1	0	1	0	0			
Prohibition	0	0	0	1	0	1	0	1			
				:	:	:	:	:			
				1	1	1	1	1			

Select address 20 (hex)

ATT	MSB	Volume Attenuation						LSB
	D7	D6	D5	D4	D3	D2	D1	D0
Prohibition	0	0	0	0	0	0	0	0
	0	0	0	0	0	0	0	1
	:	:	:	:	:	:	:	:
	0	1	1	1	1	1	1	1
0dB	1	0	0	0	0	0	0	0
-1dB	1	0	0	0	0	0	0	1
-2dB	1	0	0	0	0	0	1	0
:	:	:	:	:	:	:	:	:
-35dB	1	0	1	0	0	0	1	1
-36dB	1	0	1	0	0	1	0	0
Prohibition	1	0	1	0	0	1	0	1
	:	:	:	:	:	:	:	:
	1	1	1	1	1	1	1	0
-∞dB	1	1	1	1	1	1	1	1

 : Initial condition

Select address 28, 29, 2A, 2B (hex)

ATT	MSB	Fader Attenuation						LSB
	D7	D6	D5	D4	D3	D2	D1	D0
Prohibition	0	0	0	0	0	0	0	0
	0	0	0	0	0	0	0	1
	:	:	:	:	:	:	:	:
	0	1	1	1	1	1	1	1
0dB	1	0	0	0	0	0	0	0
-1dB	1	0	0	0	0	0	0	1
-2dB	1	0	0	0	0	0	1	0
:	:	:	:	:	:	:	:	:
-62dB	1	0	1	1	1	1	1	0
-63dB	1	0	1	1	1	1	1	1
Prohibition	1	1	0	0	0	0	0	0
	:	:	:	:	:	:	:	:
	1	1	1	1	1	1	1	0
-∞dB	1	1	1	1	1	1	1	1

Select address 51, 57 (hex)

Gain	MSB	Bass/Treble Gain						LSB	
	D7	D6	D5	D4	D3	D2	D1	D0	
0dB	Bass/ Treble Boost /cut	0	0	0	0	0	0	0	
1dB				0	0	0	0	1	
2dB				0	0	0	0	1	0
3dB				0	0	0	0	1	1
4dB				0	0	1	0	0	0
5dB				0	0	1	0	0	1
6dB				0	0	1	1	1	0
7dB				0	0	1	1	1	1
8dB				0	1	0	0	0	0
9dB				0	1	0	0	0	1
10dB				0	1	0	0	1	0
11dB				0	1	0	1	1	1
12dB				0	1	1	0	0	0
13dB				0	1	1	0	0	1
14dB				0	1	1	1	1	0
15dB				0	1	1	1	1	1
16dB				1	0	0	0	0	0
17dB				1	0	0	0	0	1
18dB				1	0	0	0	1	0
19dB				1	0	0	1	1	1
20dB				1	0	1	0	0	0
Prohibition	1	0	1	0	0	1			
	:	:	:	:	:	:			
	1	1	1	1	1	1			

Select address 51, 57 (hex)

Mode	MSB	Bass/Treble Boost/Cut				LSB	
	D7	D6	D5	D4	D3	D2	D1
Boost	0	0	0	Bass/Treble Gain			
Cut	1						

 : Initial condition

Select address 75 (hex)

Gain	MSB				Loudness Gain			LSB
	D7	D6	D5	D4	D3	D2	D1	D0
0dB	0	0	0	0	0	0	0	0
1dB					0	0	0	1
2dB					0	0	1	0
3dB					0	0	1	1
4dB					0	1	0	0
5dB					0	1	0	1
6dB					0	1	1	0
7dB					0	1	1	1
8dB					1	0	0	0
9dB					1	0	0	1
10dB					1	0	1	0
11dB					1	0	1	1
12dB					1	1	0	0
13dB					1	1	0	1
14dB					1	1	1	0
15dB					1	1	1	1

: Initial condition

●Volume / Fader volume attenuation of the details

Volume attenuation is 0dB to -36dB/Fader volume is 0dB to -63dB

(dB)	D7	D6	D5	D4	D3	D2	D1	D0	(dB)	D7	D6	D5	D4	D3	D2	D1	D0
0	1	0	0	0	0	0	0	0	-33	1	0	1	0	0	0	0	1
-1	1	0	0	0	0	0	0	1	-34	1	0	1	0	0	0	1	0
-2	1	0	0	0	0	0	1	0	-35	1	0	1	0	0	0	1	1
-3	1	0	0	0	0	0	1	1	-36	1	0	1	0	0	1	0	0
-4	1	0	0	0	0	1	0	0	-37	1	0	1	0	0	1	1	0
-5	1	0	0	0	0	1	1	1	-38	1	0	1	0	0	1	1	0
-6	1	0	0	0	0	1	1	0	-39	1	0	1	0	0	1	1	1
-7	1	0	0	0	0	1	1	1	-40	1	0	1	0	1	0	0	0
-8	1	0	0	0	1	0	0	0	-41	1	0	1	0	1	0	0	1
-9	1	0	0	0	1	0	0	1	-42	1	0	1	0	1	0	1	0
-10	1	0	0	0	1	0	1	0	-43	1	0	1	0	1	0	1	1
-11	1	0	0	0	1	0	1	1	-44	1	0	1	0	1	1	0	0
-12	1	0	0	0	1	1	0	0	-45	1	0	1	0	1	1	0	1
-13	1	0	0	0	1	1	0	1	-46	1	0	1	0	1	1	1	0
-14	1	0	0	0	1	1	1	0	-47	1	0	1	0	1	1	1	1
-15	1	0	0	0	1	1	1	1	-48	1	0	1	1	0	0	0	0
-16	1	0	0	1	0	0	0	0	-49	1	0	1	1	0	0	0	1
-17	1	0	0	1	0	0	0	1	-50	1	0	1	1	0	0	1	0
-18	1	0	0	1	0	0	1	0	-51	1	0	1	1	0	0	1	1
-19	1	0	0	1	0	0	1	1	-52	1	0	1	1	0	1	0	0
-20	1	0	0	1	0	1	0	0	-53	1	0	1	1	0	1	0	1
-21	1	0	0	1	0	1	0	1	-54	1	0	1	1	0	1	1	0
-22	1	0	0	1	0	1	1	0	-55	1	0	1	1	0	1	1	1
-23	1	0	0	1	0	1	1	1	-56	1	0	1	1	1	0	0	0
-24	1	0	0	1	1	0	0	0	-57	1	0	1	1	1	0	0	1
-25	1	0	0	1	1	0	0	1	-58	1	0	1	1	1	0	1	0
-26	1	0	0	1	1	0	1	0	-59	1	0	1	1	1	0	1	1
-27	1	0	0	1	1	0	1	1	-60	1	0	1	1	1	1	0	0
-28	1	0	0	1	1	1	0	0	-61	1	0	1	1	1	1	0	1
-29	1	0	0	1	1	1	0	1	-62	1	0	1	1	1	1	1	0
-30	1	0	0	1	1	1	1	0	-63	1	0	1	1	1	1	1	1
-31	1	0	0	1	1	1	1	1	-∞	1	1	1	1	1	1	1	1
-32	1	0	1	0	0	0	0	0	-	-	-	-	-	-	-	-	-

 : Initial condition

(6) About power on reset

At ON of supply voltage circuit made initialization inside IC is built-in. Please send data to all address as initial data at supply voltage on. And please supply mute at set side until this initial data is sent.

Item	Symbol	Limit			Unit	Condition
		Min.	Typ.	Max.		
Rise time of VCC	Trise	20	—	—	usec	VCC rise time from 0V to 5V
VCC voltage of release power on reset	Vpor	—	5.0	—	V	



●About Advanced switching circuit

【1】 About Advanced switch

1-1. Effect of Advanced switch

It is the ROHM original technology for prevention of switching noise. When gain switching such as volume and tone control is done momentarily, a music signal isn't continuous, and unpleasant shock noise is made. Advanced switch can reduce shock noise with the technology which signal wave shape is complemented so that a music signal may not continue drastically.

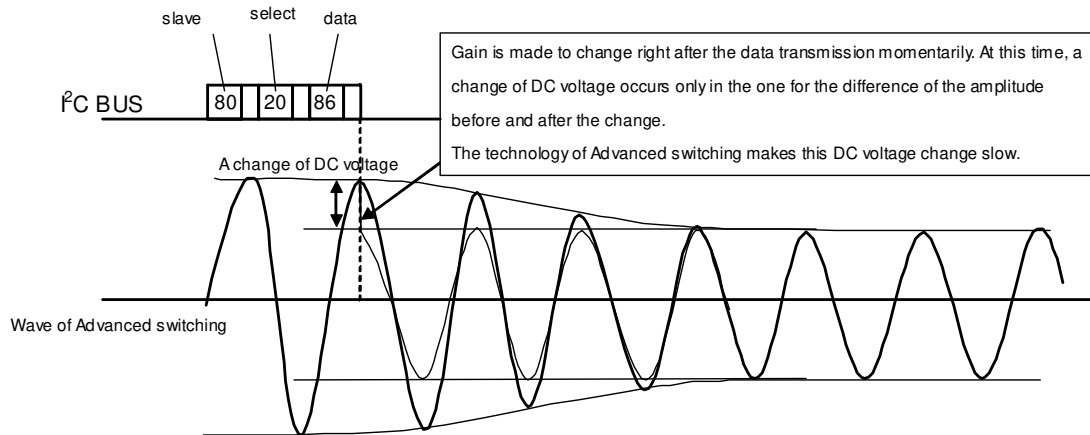

Advanced switch starts switching after the control data from a microcomputer are received. It takes one fixed time, and wave shape transits as the above figure. The data transmitted by a microcomputer are processed inside, and the most suitable movement is done inside the IC so that switching shock noise may not be made.

But, it presumes by the transmitting timing when it doesn't become intended switching wave shape because it is the function which needs time. The example in which there are relation with the switching time of the data transmitting timing and the reality are shown in the following. It asks for design when it is confirmed well.

1-2. About a kind of transmission method

- A data setup except for the item for advanced switch (p11/27 select address and the data format, the thing which isn't indicated by gray)  
There is no regulation in transmission specially.
- The data setup of the item for advanced switch (p11/27 select address and the data format, the thing which is indicated by gray)  
Though there is no regulation in data transmission, the switching order when data are transmitted to several blocks follows the next 2.

[2] About transmission DATA of advanced switching item

2-1. About switching time of advanced switch

Advanced switching time are equivalent to the switching time and invalid time(effect-less time) inside the IC, and switching time and invalid time is equal to 11.2msec x (1±0.4(dispersion margin))

Therefore, actual Advanced switching time ( $T_{soft}$ ) is defined as follows.

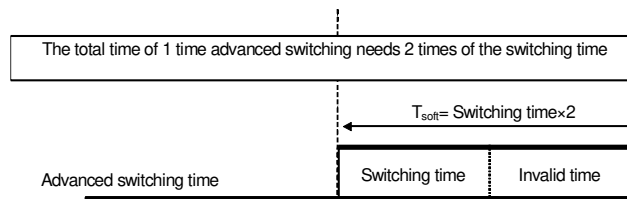

Advanced switching time  $T_{soft}$  is,  $T_{soft}$  = switching time and invalid time(= switching time x 2).

2-2. About the data transmitting timing in same block state and the switching movement

■ Transmitting example 1

A time chart to the start of switching from the data transmission is as following.

At first, the example are shown as below when the interval time is sufficient in which transmission of the same blocks.

(Sufficient interval means time which is more than  $T_{soft}$  maximum value, 11.2msec x 1.4(dispersion margin) x 2 = 31.4msec

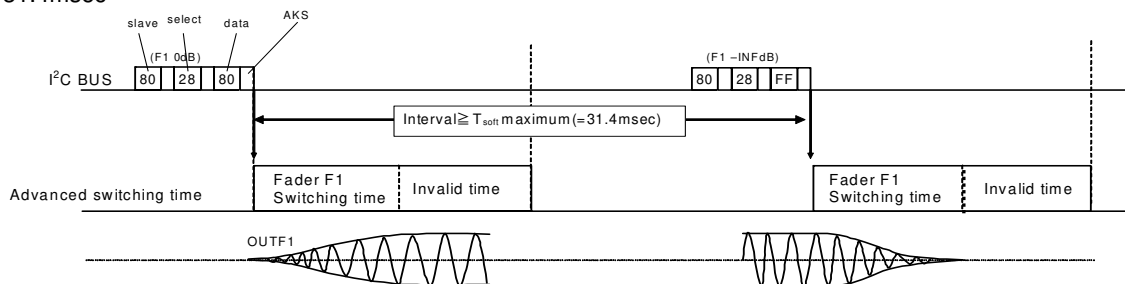

■ Transmitting example 2

Next, when a transmitting interval isn't sufficient (when it is shorter than the above interval), the example is shown. In case data are transmitted during the first switching movement, the next switching movement is started in succession after the first switching movement is finished.

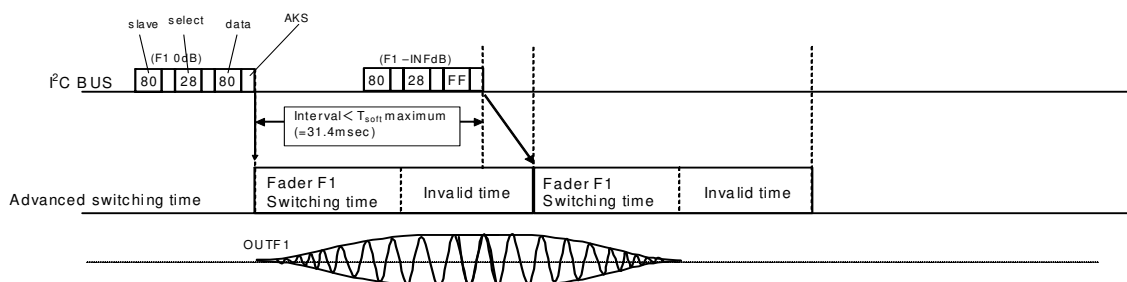

■ Transmitting example 3

Next, the example of the switching movement when a transmitting interval was shortened more is shown. Inside the IC, It has the buffer which memorizes data, and a buffer always does transmitting data. But, data of +4dB which transmitted to the second become invalid with this example because the buffer holds only the latest data.

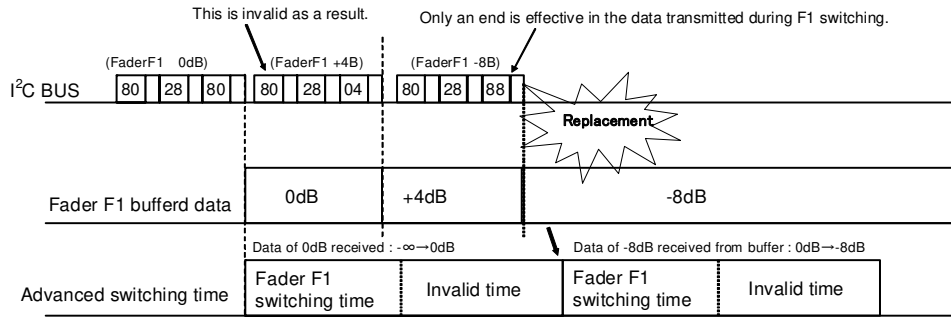

■ Transmitting example 4

At first, transmitting data are stored in the maintenance data, and next it is written in the setup data in which gain is set up to. But, in case there is no difference between the transmitting data and the setup data as a refresh data, Advanced switch movement isn't started.

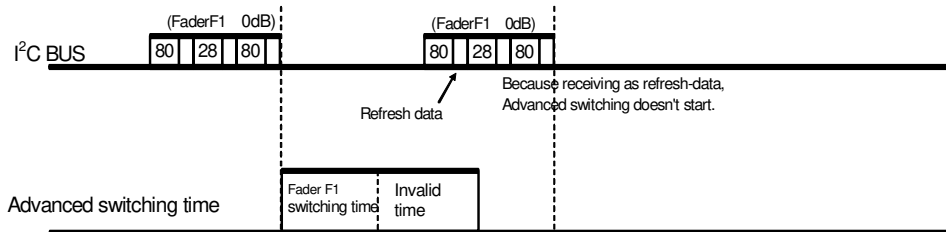

2-3. About the data transmitting timing and the switching movement in several block state

When data are transmitted to several blocks, treatment in the BS (block state) unit is carried out inside the IC. The order of advanced switch movement start is decided in advance dependent on BS.

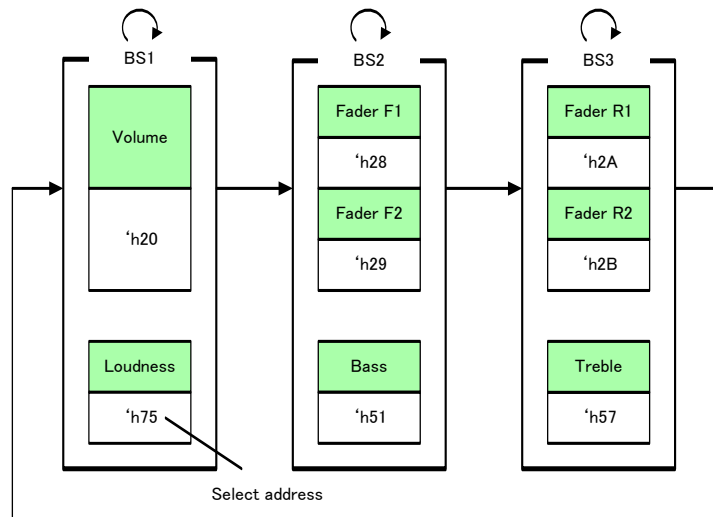

The order of advanced switch start

※It is possible that blocks in the same BS start switching at the same timing.

Figure 16. The example of the timing of command of in I<sup>2</sup>Cdata transmitting

■ Transmitting example 5

About the transmission to several blocks also, as explained in the previous section, though there is no restriction of the I2C BUS data transmitting timing, the start timing of switching follows the figure of previous page, figure16. Therefore, it isn't based on the data transmitting order, and an actual switching order becomes as the figure16 (Transmitting example 6). Each block data is being transmitted separately in the transmitting example 5, but it becomes the same result even if data are transmitted by automatic increment.

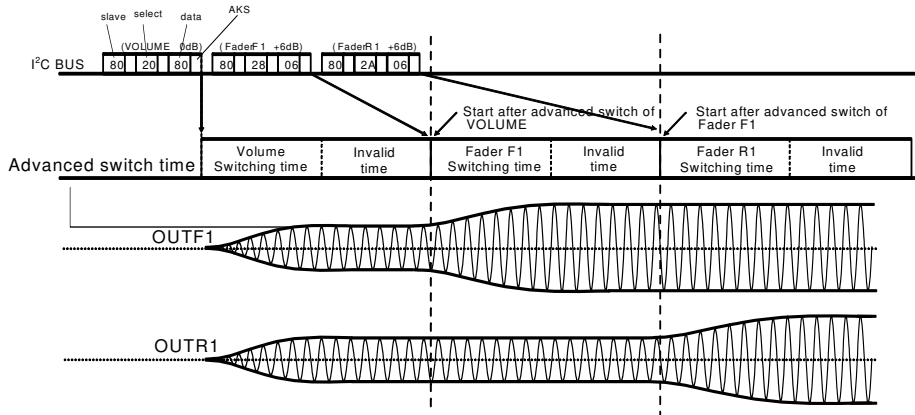

■ Transmitting example 6

When an actual switching order is different from the transmitting order or data except for the same BS are transmitted at the timing when advanced switch movement isn't finished, switching of the next BS is done after the present switching completion.

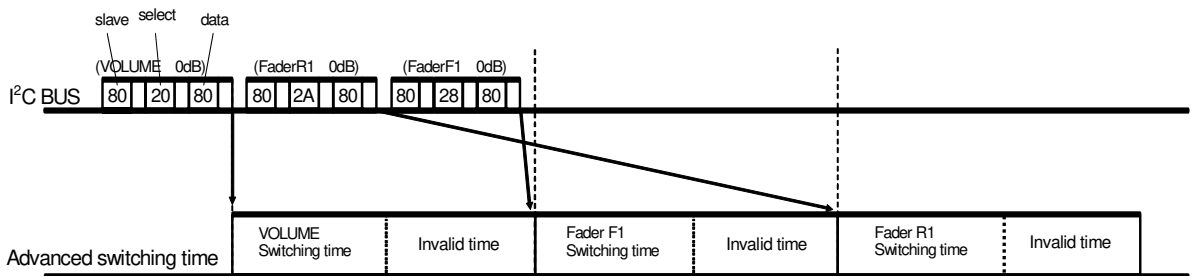

■ Transmitting example 7

In this example, data of BS2 and BS3 are transmitted during Advances switching of BS2(same BS2 group).

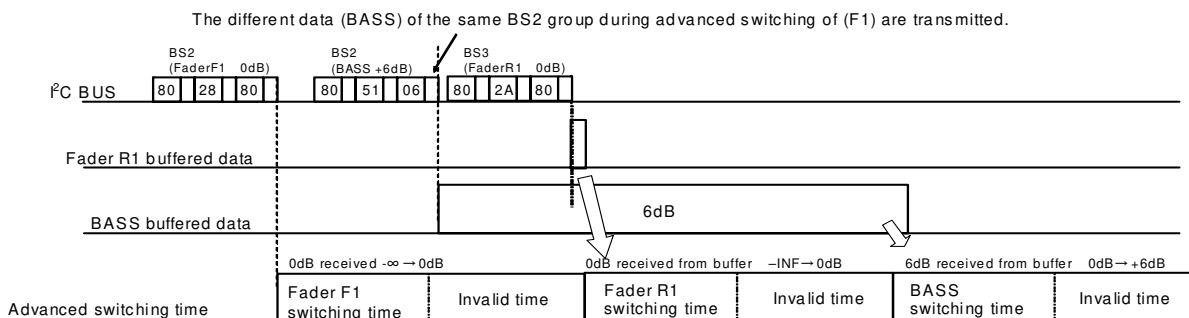

2-4. About gain switching of TONE(Bass/ Treble)

When gain is changed from boost to cut (or, from cut to boost), advanced switching is two-step transition movement that it go through 0dB to prevent the occurrence of the switching noise. And when boost/cut doesn't change between before switching and after switching, advanced switching is the same as 2-2, 2-3. About advanced switching time, it is same time length as other switching time length.

■ Transmitting example 8

In case changing Bass gain +15dB from -15dB

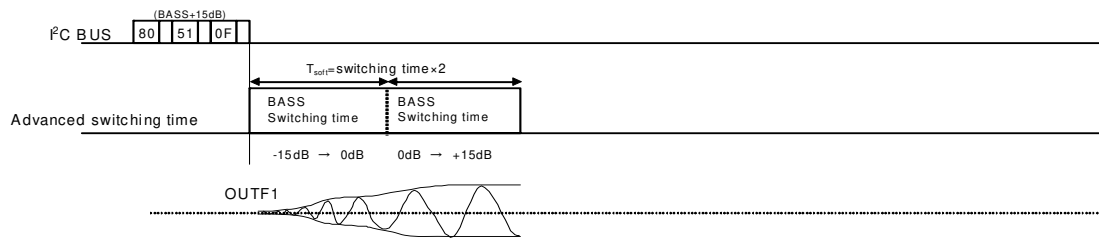

[3] Advanced switch transmitting timing list

3-1. Volume/Fader(F1,F2,R1,R2)/TONE(BASS,TREBLE,LOUDNESS)

	Advanced switch stand by	→	Advanced switch active
Transmission timing	optional	←	optional
Start timing	Starts right after the data transmission		Starts right after present switching was finished.
Advanced switching time	$T_{soft}^{※1}$		$T_{soft}$

3-2. TONE BOOST ⇔ CUT

	Advanced switch stand by	→	Advanced switch active
Transmission timing	optional	←	optional
Start timing	Starts right after the data transmission		Starts right after present switching was finished.
Advanced switching time	$T_{soft}^{※2}$		$T_{soft}$

※1 Advanced switching time  $T_{soft}$  equals to 2times of swithcing time.

※2 About  $T_{soft}$  of TONE BOOST⇔CUT, the time length until gain switching finishes is equal to 2times of swithcing time, because it go through 0dB when switching from initial gain to requested gain. In this case, Advanced switching time is same as ※1 above.

●Application Circuit Diagram

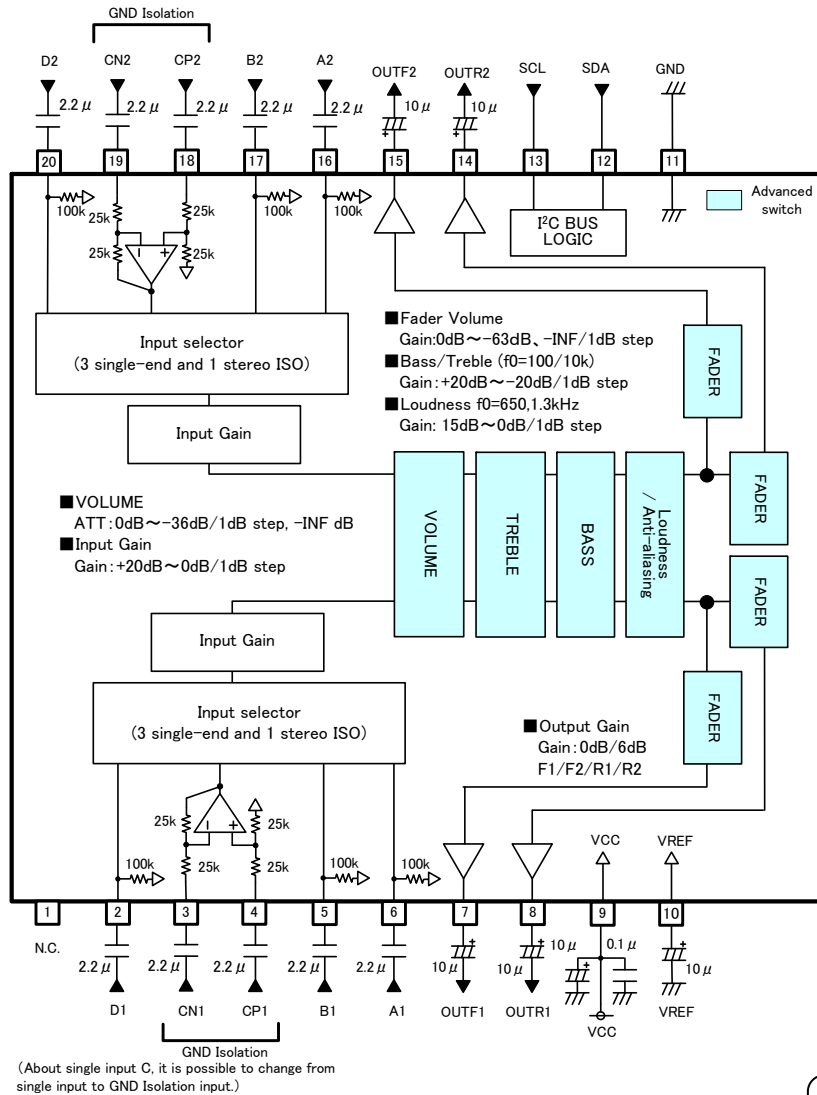

Figure 17. Application Circuit Diagram

UNIT  
RESISTANCE: Ω  
CAPACITANCE: F

- Notes on wiring**
- ① Please connect the decoupling capacitor of a power supply in the shortest distance as much as possible to GND.
  - ② Lines of GND shall be one-point connected.
  - ③ Wiring pattern of Digital shall be away from that of analog unit and cross-talk shall not be acceptable.
  - ④ Lines of SCL and SDA of I<sup>2</sup>C BUS shall not be parallel if possible.  
The lines shall be shielded, if they are adjacent to each other.
  - ⑤ Lines of analog input shall not be parallel if possible. The lines shall be shielded, if they are adjacent to each other.

●Thermal Derating Curve

About the thermal design by the IC

Characteristics of an IC have a great deal to do with the temperature at which it is used, and exceeding absolute maximum ratings may degrade and destroy elements. Careful consideration must be given to the heat of the IC from the two standpoints of immediate damage and long-term reliability of operation.

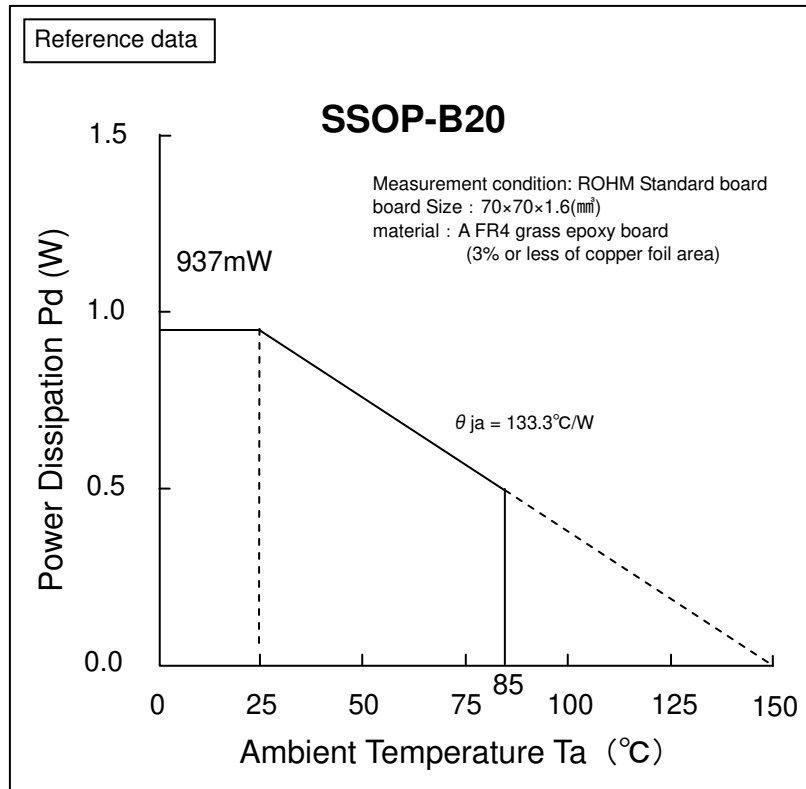

Figure 18. Temperature Derating Curve

Note) Values are actual measurements and are not guaranteed.

Power dissipation values vary according to the board on which the IC is mounted.

●Terminal Equivalent Circuit and Description

Terminal Name	Terminal Voltage	Equivalent Circuit	Terminal Description
A1 A2 B1 B2 D1 D2	4.2		A terminal for signal input. The input impedance is 100kΩ(typ).
CP1 CP2	4.2		A terminal for positive input of ground isolation amplifier.
CN1 CN2	4.2		A terminal for negative input of ground isolation amplifier.
SCL	-		A terminal for clock input of I <sup>2</sup> C BUS communication.
SDA	-		A terminal for data input of I <sup>2</sup> C BUS communication.



Terminal Name	Terminal Voltage	Equivalent Circuit	Terminal Description
OUTF1 OUTR1 OUTR2 OUTF2	4.2		A terminal for fader output.
N.C.	-	/	Non connect terminal
VCC	8.5	/	Power supply terminal.
GND	0	/	Ground terminal.
VREF	4.2		BIAS terminal. Voltage for reference bias of analog signal system. The simple pre-charge circuit and simple discharge circuit for an external capacitor are built in.

※The figure in the pin explanation and input/output equivalent circuit is reference value, it doesn't guarantee the value.

●Operational Notes

1. Absolute-Maximum-Rating Voltage

When voltage is impressed to VCC exceeding absolute-maximum-rating voltage, circuit current increase rapidly, and it may result in property degradation and destruction of a device.

When impressed by a VCC terminal (9pin) especially by serge examination etc., even if it includes an of operation voltage + serge pulse component, be careful not to impress voltage (about 14V) greatly more than absolute-maximum-rating voltage.

2. About a signal input part

1) About constant set up of input coupling capacitor

In the signal input terminal, the constant setting of input coupling capacitor C(F) be sufficient input impedance  $R_{IN}(\Omega)$  inside IC and please decide. The first HPF characteristic of RC is composed.

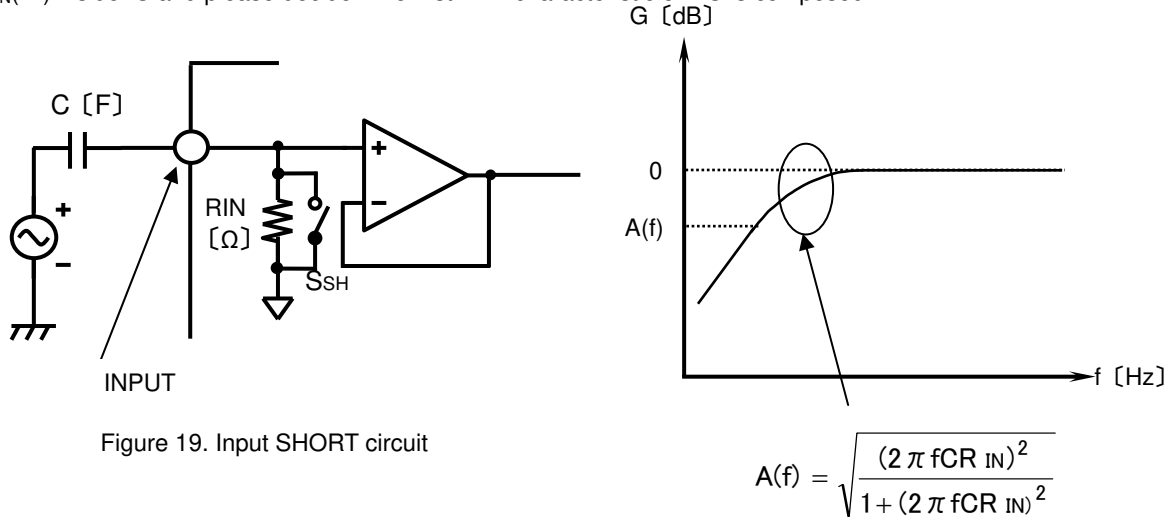

Figure 19. Input SHORT circuit

2) About the input SHORT

SHORT mode is the command which makes switch  $S_{SH} = ON$  an input selector part and input impedance  $R_{IN}$  of all terminals, and makes resistance small. Switch  $S_{SH}$  is OFF when not choosing a SHORT command.

A constant time becomes small at the time of this command twisting to the resistance inside the capacitor connected outside and LSI. The charge time of a capacitor becomes short.

Since SHORT mode turns ON the switch of  $S_{SH}$  and makes it low impedance, please use it at the time of a non-signal.

3. About output load characteristics

The usages of load for output are below (reference). Please use the load more than 10kΩ (TYP).

The target output terminal

Terminal No.	Terminal Name	Terminal No.	Terminal Name
7	OUTF1	8	OUTR1
15	OUTF2	14	OUTR2

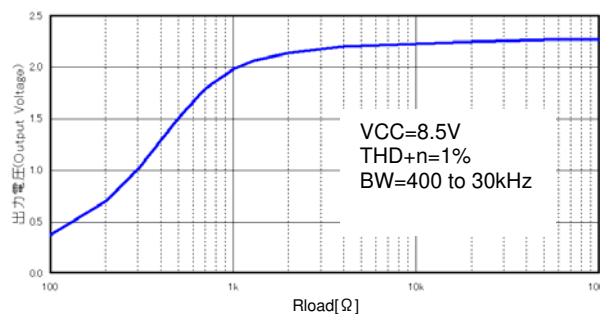

Fig.16 Output Load Characteristic Vcc=8.5V(reference data)

Status of this document

The Japanese version of this document is formal specification. A customer may use this translation version only for a reference to help reading the formal version.

If there are any differences in translation version of this document formal version takes priority

●Ordering Information

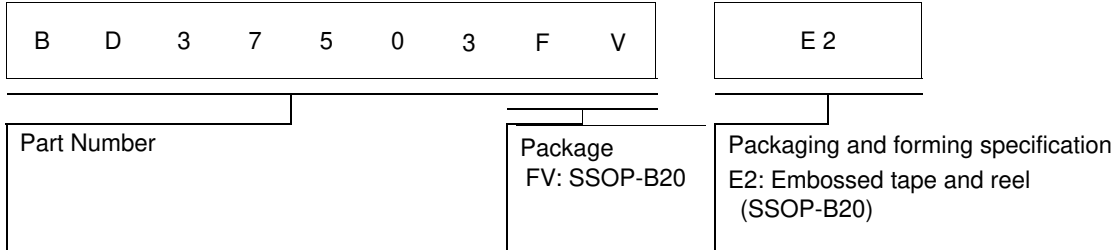

●Physical Dimension Tape and Reel Information

SSOP-B20

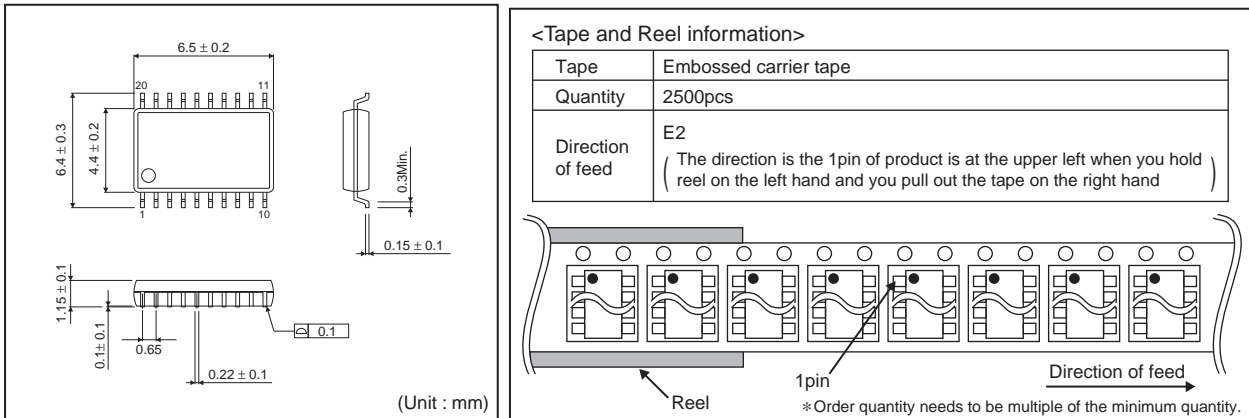

●Marking Diagram(s)(TOP VIEW)

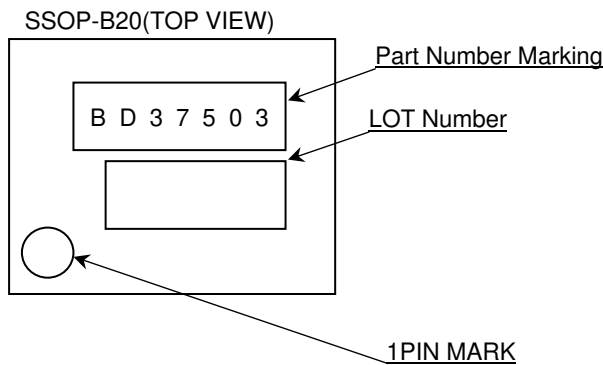

## ●Revision History

Date	Revision	Changes
03.Aug.2012	001	New Release
03.Jul.2013	002	2/28 Figure2 Correction

# Notice

## Precaution on using ROHM Products

- Our Products are designed and manufactured for application in ordinary electronic equipments (such as AV equipment, OA equipment, telecommunication equipment, home electronic appliances, amusement equipment, etc.). If you intend to use our Products in devices requiring extremely high reliability (such as medical equipment <sup>(Note 1)</sup>, transport equipment, traffic equipment, aircraft/spacecraft, nuclear power controllers, fuel controllers, car equipment including car accessories, safety devices, etc.) and whose malfunction or failure may cause loss of human life, bodily injury or serious damage to property ("Specific Applications"), please consult with the ROHM sales representative in advance. Unless otherwise agreed in writing by ROHM in advance, ROHM shall not be in any way responsible or liable for any damages, expenses or losses incurred by you or third parties arising from the use of any ROHM's Products for Specific Applications.

(Note1) Medical Equipment Classification of the Specific Applications

JAPAN	USA	EU	CHINA
CLASS III	CLASS III	CLASS II b	CLASS III
CLASS IV		CLASS III	

- ROHM designs and manufactures its Products subject to strict quality control system. However, semiconductor products can fail or malfunction at a certain rate. Please be sure to implement, at your own responsibilities, adequate safety measures including but not limited to fail-safe design against the physical injury, damage to any property, which a failure or malfunction of our Products may cause. The following are examples of safety measures:
  - Installation of protection circuits or other protective devices to improve system safety
  - Installation of redundant circuits to reduce the impact of single or multiple circuit failure
- Our Products are designed and manufactured for use under standard conditions and not under any special or extraordinary environments or conditions, as exemplified below. Accordingly, ROHM shall not be in any way responsible or liable for any damages, expenses or losses arising from the use of any ROHM's Products under any special or extraordinary environments or conditions. If you intend to use our Products under any special or extraordinary environments or conditions (as exemplified below), your independent verification and confirmation of product performance, reliability, etc. prior to use, must be necessary:
  - Use of our Products in any types of liquid, including water, oils, chemicals, and organic solvents
  - Use of our Products outdoors or in places where the Products are exposed to direct sunlight or dust
  - Use of our Products in places where the Products are exposed to sea wind or corrosive gases, including Cl<sub>2</sub>, H<sub>2</sub>S, NH<sub>3</sub>, SO<sub>2</sub>, and NO<sub>2</sub>
  - Use of our Products in places where the Products are exposed to static electricity or electromagnetic waves
  - Use of our Products in proximity to heat-producing components, plastic cords, or other flammable items
  - Sealing or coating our Products with resin or other coating materials
  - Use of our Products without cleaning residue of flux (even if you use no-clean type fluxes, cleaning residue of flux is recommended); or Washing our Products by using water or water-soluble cleaning agents for cleaning residue after soldering
  - Use of the Products in places subject to dew condensation
- The Products are not subject to radiation-proof design.
- Please verify and confirm characteristics of the final or mounted products in using the Products.
- In particular, if a transient load (a large amount of load applied in a short period of time, such as pulse. is applied, confirmation of performance characteristics after on-board mounting is strongly recommended. Avoid applying power exceeding normal rated power; exceeding the power rating under steady-state loading condition may negatively affect product performance and reliability.
- De-rate Power Dissipation (Pd) depending on Ambient temperature (Ta). When used in sealed area, confirm the actual ambient temperature.
- Confirm that operation temperature is within the specified range described in the product specification.
- ROHM shall not be in any way responsible or liable for failure induced under deviant condition from what is defined in this document.

## Precaution for Mounting / Circuit board design

- When a highly active halogenous (chlorine, bromine, etc.) flux is used, the residue of flux may negatively affect product performance and reliability.
- In principle, the reflow soldering method must be used; if flow soldering method is preferred, please consult with the ROHM representative in advance.

For details, please refer to ROHM Mounting specification

**Precautions Regarding Application Examples and External Circuits**

1. If change is made to the constant of an external circuit, please allow a sufficient margin considering variations of the characteristics of the Products and external components, including transient characteristics, as well as static characteristics.
2. You agree that application notes, reference designs, and associated data and information contained in this document are presented only as guidance for Products use. Therefore, in case you use such information, you are solely responsible for it and you must exercise your own independent verification and judgment in the use of such information contained in this document. ROHM shall not be in any way responsible or liable for any damages, expenses or losses incurred by you or third parties arising from the use of such information.

**Precaution for Electrostatic**

This Product is electrostatic sensitive product, which may be damaged due to electrostatic discharge. Please take proper caution in your manufacturing process and storage so that voltage exceeding the Products maximum rating will not be applied to Products. Please take special care under dry condition (e.g. Grounding of human body / equipment / solder iron, isolation from charged objects, setting of Ionizer, friction prevention and temperature / humidity control).

**Precaution for Storage / Transportation**

1. Product performance and soldered connections may deteriorate if the Products are stored in the places where:
  - [a] the Products are exposed to sea winds or corrosive gases, including Cl<sub>2</sub>, H<sub>2</sub>S, NH<sub>3</sub>, SO<sub>2</sub>, and NO<sub>2</sub>
  - [b] the temperature or humidity exceeds those recommended by ROHM
  - [c] the Products are exposed to direct sunshine or condensation
  - [d] the Products are exposed to high Electrostatic
2. Even under ROHM recommended storage condition, solderability of products out of recommended storage time period may be degraded. It is strongly recommended to confirm solderability before using Products of which storage time is exceeding the recommended storage time period.
3. Store / transport cartons in the correct direction, which is indicated on a carton with a symbol. Otherwise bent leads may occur due to excessive stress applied when dropping of a carton.
4. Use Products within the specified time after opening a humidity barrier bag. Baking is required before using Products of which storage time is exceeding the recommended storage time period.

**Precaution for Product Label**

QR code printed on ROHM Products label is for ROHM's internal use only.

**Precaution for Disposition**

When disposing Products please dispose them properly using an authorized industry waste company.

**Precaution for Foreign Exchange and Foreign Trade act**

Since our Products might fall under controlled goods prescribed by the applicable foreign exchange and foreign trade act, please consult with ROHM representative in case of export.

**Precaution Regarding Intellectual Property Rights**

1. All information and data including but not limited to application example contained in this document is for reference only. ROHM does not warrant that foregoing information or data will not infringe any intellectual property rights or any other rights of any third party regarding such information or data. ROHM shall not be in any way responsible or liable for infringement of any intellectual property rights or other damages arising from use of such information or data.:
2. No license, expressly or implied, is granted hereby under any intellectual property rights or other rights of ROHM or any third parties with respect to the information contained in this document.

**Other Precaution**

1. This document may not be reprinted or reproduced, in whole or in part, without prior written consent of ROHM.
2. The Products may not be disassembled, converted, modified, reproduced or otherwise changed without prior written consent of ROHM.
3. In no event shall you use in any way whatsoever the Products and the related technical information contained in the Products or this document for any military purposes, including but not limited to, the development of mass-destruction weapons.
4. The proper names of companies or products described in this document are trademarks or registered trademarks of ROHM, its affiliated companies or third parties.

**General Precaution**

1. Before you use our Products, you are requested to carefully read this document and fully understand its contents. ROHM shall not be in any way responsible or liable for failure, malfunction or accident arising from the use of any ROHM's Products against warning, caution or note contained in this document.
2. All information contained in this document is current as of the issuing date and subject to change without any prior notice. Before purchasing or using ROHM's Products, please confirm the latest information with a ROHM sales representative.
3. The information contained in this document is provided on an "as is" basis and ROHM does not warrant that all information contained in this document is accurate and/or error-free. ROHM shall not be in any way responsible or liable for any damages, expenses or losses incurred by you or third parties resulting from inaccuracy or errors of or concerning such information.