



PC, DVI, VIDEO, HD Component INTERFACE CONTROLLER FOR TFT PANEL

Model: SVH-1920v2

Part number : 41752004X-3 or up

INSTRUCTIONS

CONTENTS

Page:	2. Introduction, How to Proceed, Usage Note, Disclaimer
	3. System design – Diagram of a suggested system
	4. Assembly notes – Important information about system elements
	6. Connection & Operation – How to use the controller
	13. Connectors, pinouts & jumpers – Essential connection information
	27. Controller dimensions
	28. Application notes
	30. Troubleshooting
	31. Specifications
	32. Appendix I – Supported graphics modes table
	35. Appendix II – RS-232 control protocols
	48. Appendix III – Mapping definition
	52. Appendix IV – Auto Color Gain
	53. Appendix V – DV remote control unit work for SVH-1920v2
	54. Appendix VII – PIP mix table
	55. Appendix VII – HD-1000 / HD-2000 connection
	56. Appendix VIII – Procedure for showing how to select the baud rate
	58. Warranty, Caution & Limitation of Liability, Trademarks
	59. Contact details
	60. Revision History

It is essential that these instructions are read and understood before connecting or powering up this controller.

Introduction

Designed for LCD monitor and other flat panel display applications, the SVH-1920v2 is a feature rich interface controller for :

- TFT (active matrix) LCD panels of 1920x1200, 1920x1080, 1920x480, 1600x1200, 1600x900, 1680x1050, 1440x900, 1366x768, 1280x1024, 1280x800, 1280x768 1024x768, 1024x600, 800x600, 800x480 and 640x480 resolutions.
- Computer video signals of VGA, SVGA, XGA, SXGA, WXGA, UXGA, WUXGA standard.
- Video signals of NTSC, PAL and SECAM standard.
- DVI input support up to 1920x1200 60Hz input signals
- HD-SDI input support by using optional HD-SDI adaptor board (Kit P/N 546013410-3 / P/N 546013310-3)

Ordering information :

Controller	Part number	Ordering part number
SVH-1920v2	P/N 41752004X-3	P/N 4175200XX-3

HOW TO PROCEED

- Ensure you have all parts & that they are correct, refer to:
 - Connection diagram

Controller Solution Generator

Full web resource matching controllers & panels with **connection diagrams** for download.
See at : <http://www.digitalview.com/controllers/csg.php>

- Connector reference (in following section)
- Assembly notes (refer to page 4 – 5)
- Check controller switch & jumper settings (errors may damage the panel)
- Prepare the PC
- Connect the parts
- Understand the operation & functions

IMPORTANT USAGE NOTE

This equipment is for use by developers and integrators, the manufacturer accepts no liability for damage or injury caused by the use of this product. It is the responsibility of the developer, integrators or other user of this product to:

- Ensure that all necessary and appropriate safety measures are taken.
- Obtain suitable regulatory approvals as may be required.
- **Check power settings to all component parts before connection.**

DISCLAIMER

There is no implied or expressed warranty regarding this material.

SYSTEM DESIGN

A typical LCD based display system utilizing this controller is likely to comprise the following:

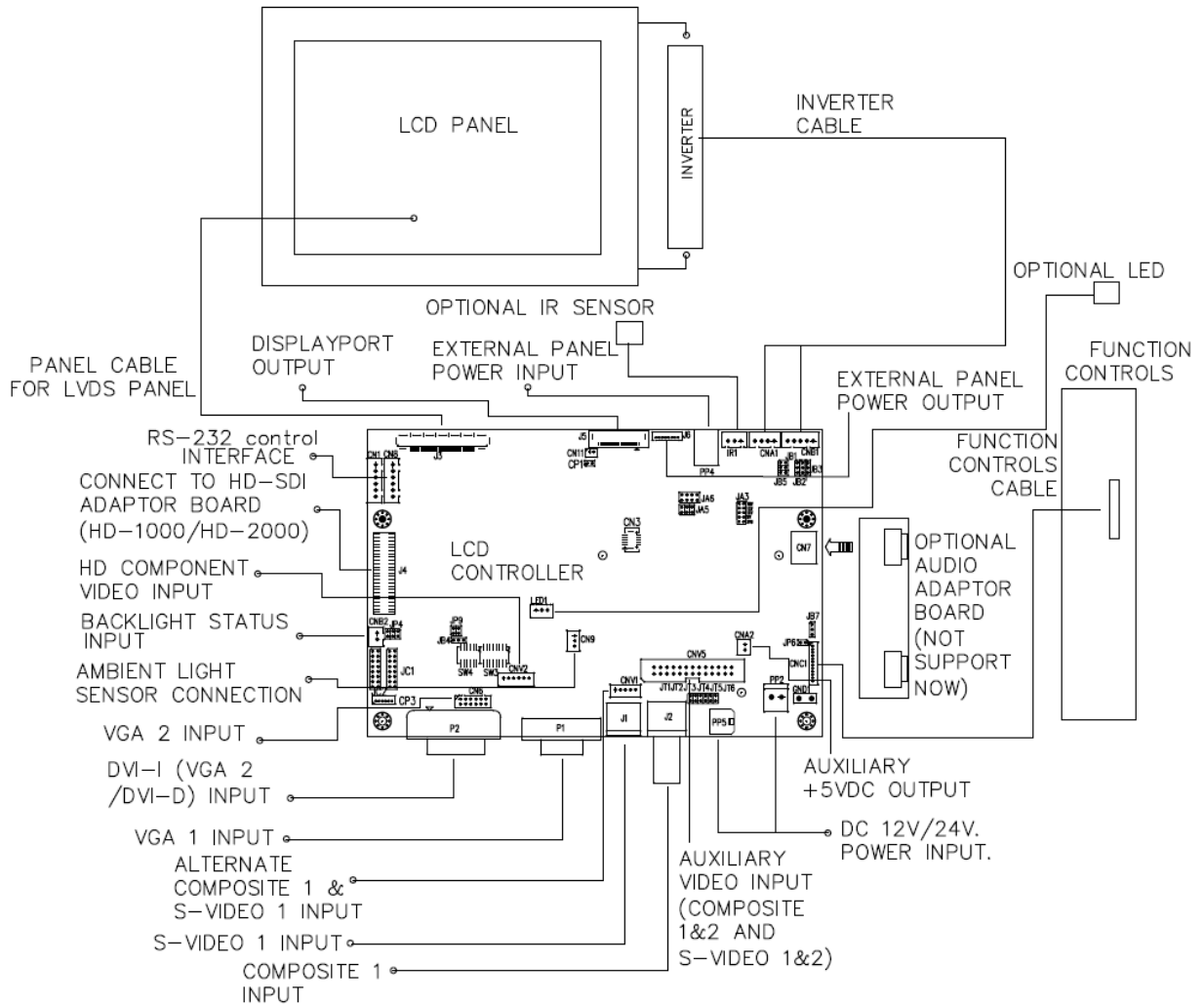

ASSEMBLY NOTES

This controller is designed for monitor and custom display projects using 1920x1200 or 1920x1080 or 1600x1200 or 1600x900 or 1680x1050 or 1440x900 or 1366x768 or 1280 x 1024 or 1280x800 or 1024 x 768 or or 1024x600 or 800x600 or 800x480 or 640x480 resolution TFT panels with a VGA, SVGA, WXGA, XGA, SXGA, UXGA or WUXGA signal input. The following provides some guidelines for installation and preparation of a finished display solution.

Preparation: Before proceeding it is important to familiarize yourself with the parts making up the system and the various connectors, mounting holes and general layout of the controller. As much as possible connectors have been labeled. Guides to connectors and mounting holes are shown in the following relevant sections.

1. **LCD Panel:** This controller is designed for typical LVDS interfaced panels with panel voltage 3.3V, 5V or 12V, External for 12V~18V interface. Due to the variation between manufacturers of panels signal timing and other panel characteristics, factory setup and confirmation should be obtained before connecting to a panel. (**NOTE: Check panel power jumper settings before connection**)
2. **Controller:** Handle the controller with care as static charge may damage electronic components. Make sure correct jumper and dip switches settings to match the target LCD panel.
3. **LCD signal cable (LVDS panel):** In order to provide a clean signal it is recommended that LVDS signal cables are no longer than 46cm (18 inches). If those wire cabling is utilized these can be made into a harness with cable ties. Care should be taken when placing the cables to avoid signal interference. Additionally it may be necessary in some systems to add ferrite cores to the cable to minimize signal noise.
5. **Inverter:** This will be required for the backlight of an LCD, some LCD panels have an inverter built in. As LCD panels may have 1 or more backlight tubes and the power requirements for different panel backlights may vary it is important to match the inverter in order to obtain optimum performance. See Application notes page 18 for more information on connection.
6. **Inverter Cables:** Different inverter models require different cables and different pin assignment. Make sure correct cable pin out to match inverter. Using wrong cable pin out may damage the inverter.
7. **Function Controls:** The following section discusses the controls required and the section on connectors provides the detail. The controls are minimal: On/Off, Backlight Brightness (depends on inverter), OSD (5 momentary buttons) analog VR type or (8 momentary buttons) digital type.
The 8 momentary buttons OSD switch mount P/N 416100520-3 or OSD membrane interface P/N 416100120-3 must be used when 24VDC input.
8. **Function controls cable:** The cables to the function switches should be of suitable quality and length so that impedance does not affect performance. Generally lengths up to 1 meter (3 feet) should be acceptable.
9. **Status LED:** The pin direction of the LED should be corrected for right colour indication. Red colour stands for standby. Green colours stands for signal on. The status LED is an optional part only, can be unconnected.
10. **IR sensor:** It is an optional part only, can be unconnected if not using IR remote control. See Appendix V in details.
11. **RS-232 control interface :** Firmware upgrade and serial control via CN8 interface port.
12. **Audio add-on board P/N 416940020-3:** The audio add-on board gives the audio input and output signal connection. It is an optional part only, can be unconnected if not using audio.
13. **VGA Input Cable:** Plug the VGA cable to the connector P1 (for VGA 1) or P2 / CN6 (for VGA 2) on the controller board. As this may affect regulatory emission test results and the quality of the signal to the controller a suitably shielded cable should be utilized.
14. **DVI-D input cable :** Plug the DVI cable to the connector P2 on the controller board.
15. **Composite video input :** Standard Composite cables can be used. Reasonable quality cable should be used to avoid image quality degradation.
16. **S-Video input :** Standard S-video cables can be used. Reasonable quality cable should be used to avoid image quality degradation.
17. **Alternate composite 1 and S-video 1 input :** Plug the video input cable P/N 426000500-3 on CNV1 connector
18. **HD component video input :** Plug the component video input cable P/N 426000600-3 on CNV2 connector

20. Interface for connecting to HD-SDI adaptor board

HD-SDI (1-in-1-out) adaptor board, Kit number P/N 546013410-3 includes :	
HD-1000 adaptor (1-in-1-out)	P/N 416013410-3
Ribbon cable	P/N 426171120-3, 180mm

HD-SDI (2-in-2-out) adaptor board, Kit number P/N 546013310-3 includes :	
HD-2000 adaptor (2-in-2-out)	P/N 416013310-3
Ribbon cable	P/N 426171120-3, 180mm

21. Power Input: 12V/24VDC is required, this should be a regulated supply. The power rating is depending on the panel and inverter used. Normally, power supply with 3.5Amp current output should enough for most of 4x CCFT panels. Although the controller provides power regulation for the LCD power this does not relate to the power supplied to the backlight inverter. If an unregulated power supply is provided to an inverter any fluctuations in power may affect operation, performance and lifetime of the inverter and or backlight tubes.

22. External panel power input : Allow to supply external power to the panel separately for max 3.3V (7A) or 5V (7A) or 12V (5A) or 18V (3.5A) via PP4 power input connector.

23. Auxiliary video input : This port provides Composite video 1 & 2, S-video 1 & 2. The video input selection can be switched via RS-232 command (0x98).

24. Auxiliary +5VDC output : 2 ways connector provides +5VDC output.

25. Ambient light sensor connection : 3 ways connector provides interface for ambient light sensor connection.

26. Backlight status input : 2 ways connector provides interface for connection with panel which support the panel with backlight status monitoring function.

- **Power output:** Note the controller has an overall 3Amp current limit and the current available from the auxiliary power output will be dependent on the power input and other system requirements.
- **Power Safety:** Note that although only 12V / 24VDC is required as 'power-in' a backlight inverter for panel backlighting produces significantly higher voltages (the inverter does not connect to the ground plane). We strongly advise appropriate insulation for all circuitry.
- **EMI:** Shielding will be required for passing certain regulatory emissions tests. Also the choice of external Controller to PC signal cable can affect the result.
- **Ground:** The various PCB mounting holes are connected to the ground plane.
- **Servicing:** The board is not user serviceable or repairable. Warranty does not cover user error in connecting up to the controller and is invalidated by unauthorized modification or repairs.
- **Controller Mounting:** It is recommended that a clearance of at least 10mm is provided above and 5mm below the controller when mounted. Additionally consideration should be given to:
 - Electrical insulation.
 - Grounding.
 - EMI shielding.
 - Cable management. Note: It is important to keep panel signal cables apart from the inverter & backlight cables to prevent signal interference.
 - Heat & Ventilation: Heat generated from other sources, for example the backlight of a very high brightness panel may generate significant heat which could adversely affect the controller.
 - Other issues that may affect safety or performance.
- **PC Graphics Output:** A few guidelines:
 - Signal quality is very important, if there is noise or instability in the PC graphics output this may result in visible noise on the display.
 - Refer to graphics modes table in specifications section for supported modes.
 - Non-interlaced & interlaced video input is acceptable.

IMPORTANT: Please read the Application Notes section for more information.

CONNECTION & OPERATION

CAUTION: Never connect or disconnect parts of the display system when the system is powered up as this may cause serious damage.

CONNECTION

Connection and usage is quite straight forward (it is useful to have the relevant connection diagram available at this time):

- LCD panel & Inverter:** Connect the inverter (if it is not built-in the panel) to the CCFT lead connector of the LCD panel.
LVDS type panels: The controller board has the built-in LVDS transmitter driver. Plug the LVDS cable to J3. Insert the panel end of the cable the LCD panel connector.
- Inverter & Controller:** Plug the inverter cable to CNB1 and CNA1 (if necessary). Plug another end to the connector on the inverter.
- Function switch & Controller:** Plug the OSD switch mount cable to CNC1 on the controller board and another to the OSD switch mount.
- LED & Controller:** Plug in a 3-way with dual colour LED to connector LED1 on the controller board.
- IR & Controller:** Plug in a 3-way with IR sensor to connector IR1 on the controller board.
- Jumpers & Switches:** Check all jumpers and switches (SW3, SW4) are set correctly. Details referring the connection diagram (a separate document) or the jumpers and switches setting table (in the following section).
- Jumpers & Inverter & Panel voltage:** Particularly pay attention to the settings of JA3, JA5, JA6, JB2 and JB3. JB2 & JB3 are used for inverter control (read inverter specification and information on the jumper table to define the correct settings). JA3 & JA5 & JA6 is used for panel voltage input (read panel specification and information on the jumper table to define the correct settings).
- VGA cable & Controller:** Plug the VGA cable to the connector P1 on the controller board. VGA 2 is supported via P2 (DVI-I) or CN6 connector.
- DVI cable & Controller :** Plug the DVI cable to the connector P2 on the controller board.
- Power supply & Controller:** Plug the DC 12V/24V power in to the connector PP5 or PP2. You can consider to use DigitalView mating power cable P/N 426013800-3, 160mm for PP5 connection.
- External panel power input :** Plug power cable : P/N 426013700-3 for external panel power input (3.3 (max 7A) / 5V (max 7A) / 12V (max 5A) / 18V (max3.5))
- Power on:** Switch on the controller board and panel by using the OSD switch mount.

LED status (LED1) :

State	LED color
Backlight OFF	RED
Backlight ON	GREEN

General:

- If you are using supplied cables & accessories, ensure they are correct for the model of panel and controller.
- If you are making your own cables & connectors refer carefully to both the panel & inverter specifications and the section in this manual, "Connectors, Pinouts & Jumpers" to ensure the correct pin to pin wiring.

PC SETTINGS

The controller has been designed to take a very wide range of input signals however to optimize the PC's graphics performance we recommend choosing 60Hz vertical refresh rate – this will not cause screen flicker.

OPERATION

Once the system has been connected and switched on there are a number of functions available to adjust the display image as summarized in the following sections. The settings chosen will be saved for each mode independently.

LCD DISPLAY SYSTEM SETTINGS

NOTE: By way of explanation the following refers to a set of sample buttons that may be obtained as an option. In addition to power on/off and connection for backlight brightness the controller provides an On Screen Display of certain functions which are controlled by 5 momentary type buttons (analog VR type) or 8 momentary type buttons (digital type):

Controls	Analog VR type	Digital type
On/Off – turns controller board power on	VR toggle switch	On/Off button
Brightness – controls backlight brightness	Rotary VR	Brightness +/- buttons
Menu – Turns OSD menu On or Off (it will auto time off) – Back to previous OSD menu page	Menu button	Menu button
Select down – Moves the selector to the next function (down)	SEL DN	SEL DN
Select up – Moves the selector to the previous function (up)	SEL UP	SEL UP
+ – Increase the OSD parameter values – Go into the sub-menu page from the top – Confirm to select the OSD function	+	+
- – Decrease the OSD parameter values – Go into the sub-menu page from the bottom	-	-
Reset to Factory Defaults	Press and hold SEL DN button, then power on the controller	Press and hold SEL DN button, then power on the controller
Access "Programming Mode"	Press and hold MENU button, then power on the controller	Press and hold MENU button, then power on the controller

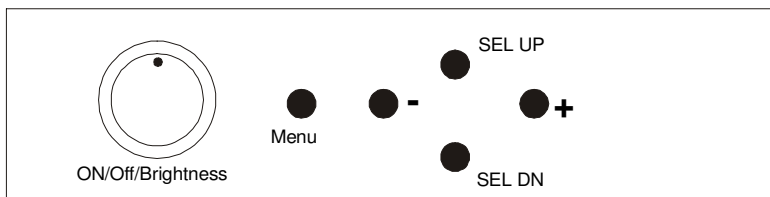

Analog VR type

12V / 24VDC power input :
Analog 10K VR Type OSD switch mount uses P/N 410680550-3 or up

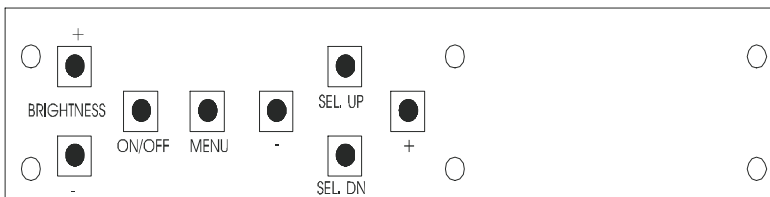







Digital type

12V / 24VDC power input :
Digital 10K Type OSD switch mount uses P/N 416100520-3 or up



Picture :

- Volume###  Increase/decrease volume level, total: 100 steps
- Brightness  Increase/decrease panel brightness level, total: 100 steps
- Contrast  Increase/decrease panel contrast level, total: 100 steps
- Saturation  Increase/decrease saturation, total: 100 steps
- Hue **  Increase/decrease Hue level, total: 100 steps
- Sharpness  Increase/decrease sharpness, total: 30 steps
- Backlight  Backlight brightness adjustment (Functions when light detector sets OFF)

Position##



Move the image position upward



Move the image position downward



Move the image position to the left



Move the image position to the right

Aspect / Size ▶

- Fill Screen : Enable full screen expansion for lower resolution Image
- Fill to Aspect Ratio: Enable fill screen expansion for lower resolution image according to aspect ratio
- 4 : 3 : scaling format in 4:3
- 16 : 9 : scaling format in 16:9
- 16 : 10 : scaling format in 16:10
- 2.35 : 1 : scaling format in 2.35:1
- 2 : 1 : scaling format in 2:1
- 1 : 1 : Display the exact image resolution on the screen without image expansion.

** : FUNCTION IN ARGB/ DVI / VIDEO NTSC MODE ONLY

: FUNCTION IN ARGB MODE ONLY

: DISPLAY WHEN AUDIO ADD-ON BOARD CONNECTED



Source : Select the input video signal

Main Port Change ▶

- VGA 1
- VGA 2
- DVI
- Composite 1
- Composite 2
- S-Video 1
- S-Video 2
- Component 1
- HD/SD SDI 1⁺⁺
- HD/SD SDI 2⁺⁺

PIP Port change ▶

PIP Off / VGA 1 / VGA 2 / DVI / Composite 1 / Composite 2 / S-Video 1 / S-Video 2 / Component 1 / HD/SD SDI 1 / HD/SD SDI 2

PIP Size ▶ : Off / PIP Size 1~18 / Size by Size / Size by Size Tall

The PIP capability on display input sources refer to Appendix VII – PIP mix table

PIP Position :



Move the PIP position upward



Move the PIP position downward



Move the PIP position to the left



Move the PIP position to the right

PIP Blend Level : 6.25% ~ 100% : PIP Transparency

PIP Swap : Swap between the main window and PIP window

PIP Auto Turn off : OFF ON : OFF / ON

ON : When PIP is no signal input after 30 seconds, the PIP window will turn off automatically.

OFF : PIP window keeps on

++ DISPLAY WHEN HD-1000/-2000 CONNECTED



Utilities :

Setup ▶

Auto Picture Setup[#] : Auto adjust the image position, phase and size

Auto Color Gain⁺ ▶ : Auto Color Calibration (See appendix IV)

- Return
- Execute

Wide Screen Mode Selection[#] ▶ : Recognize the wide screen mode coming from ARGB port

- Group 1
 - 1024x768
 - 1280x768
 - 1360x768
 - 1366x768
- Group 2
 - 1440x900
 - 1600x900

Manual Clock[#] : Adjust the image horizontal size

Manual Phase[#] : Fine tune the data sampling position (adjust image quality)

Auto Source Seek :















- Auto : OFF ON : OFF / ON

ON – Auto source select always enable

OFF – Disable auto source select function

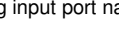
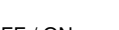
- Setup ▶ Selection for the corresponding input sources detection

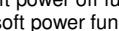
VGA 1 OFF ON

- VGA 2  
- DVI  
- Composite 1  
- Composite 2  
- S-Video 1  
- S-Video 2  
- HD/SD SDI 1**  
- HD/SD SDI 2**  

The corresponding input port name display on OSD menu will disappear once setting "OFF".

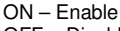
Auto Power :   OFF / ON
 ON – Enable soft power off function if absence of input signals
 OFF – Disable soft power function

Video Standard (SD)*** ▶

- AUTO
- NTSC*
- NTSC 4.43*
- PAL*
- PAL M*
- SECAM*
- (* - No image found when non-matching video system signal input)

Anti Image Retention :

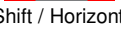
Anti Image Retention :  
 Method : Flash / Pixel Shift / Horizontal Pan / Vertical Pan
 Flash : Flashing the screen
 Pixel Shift : Image shift pixel by pixel around the screen
 Horizontal Pan : Display a pattern moving horizontally on screen.
 Vertical Pan : Display a pattern moving horizontally on screen.

Horizontal Pan Setting :

- Height > Panel Height : ÷2 / ÷4 / ÷6 / ÷8 : Configure the pattern height
- Width > Panel Width : ÷2 / ÷4 / ÷6 / ÷8 : Configure the pattern width
- Pattern : Black / White : Configure the pattern color
- Pass : 1 ~ 100 : Configure the pattern moving cycle

Vertical Pan Setting :

- Height > Panel Height : ÷2 / ÷4 / ÷6 / ÷8 : Configure the pattern height
- Width > Panel Width : ÷2 / ÷4 / ÷6 / ÷8 : Configure the pattern width
- Pattern : Black / White : Configure the pattern color
- Pass : 1 ~ 100 : Configure the pattern moving cycle

Flash Setting :

Timer : 1 ~ 100s : Configure the flashing duration
 Flash Period : 1 ~ 100 : Configure the flashing cycle
 Note : Anti Image retention state will be cleared once you press the MENU button.

Gamma : 1.8 / 1.9 / 2.0 / 2.1 / **2.2** / 2.3 / 2.4 / 2.5 / 2.6 (default 2.2)
 (Effective on V1.27.00.00 or later firmware revision)

Image Orientation** ▶

- Normal
- Horizontal Flip
- Vertical Flip
- Rotate

OSD ▶

OSD position :



Move the OSD menu image position upward



Move the OSD menu position downward



Move the OSD menu position to the left



Move the OSD menu position to the right

OSD Timeout (sec) : ON – 60 : Adjust the OSD menu timeout period in a step of 5

seconds (max 60 seconds)
ON = Continuous to display OSD menu.
60 = 60 seconds later will turn off the OSD menu.

Language : English / Spanish / French / German / Chinese :Select OSD menu language display

Display Input :  OFF / ON : Display input source info after switching source.

IR Remote control : IR Remote Enable : Set enable on IR remote control
IR Remote Disable : Set disable on IR remote control

Freeze : Freeze the image (use "+" button)

Zoom ▶

Zoom level :  : Enable the zoom in function on the image displayed.
Use "+" button to zoom in the image
Use "-" button to decrease the zoomed image

Horizontal pan :  : Pan the image horizontally

Vertical pan :  : Pan the image vertically

Factory Reset

Note : Freeze state will be cleared when you using zoom function.

Color Temperature ▶

5000K

Red Gain : 

Green Gain : 

Blue Gain : 

Red Offset : 

Green Offset : 

Blue Offset : 

Reset to Defaults : Resume to the default values

6500K

Red Gain : 

Green Gain : 

Blue Gain : 

Red Offset : 

Green Offset : 

Blue Offset : 

Reset to Defaults : Resume to the default values

8000K

Red Gain : 

Green Gain : 

Blue Gain : 

Red Offset : 

Green Offset : 

Blue Offset : 

Reset to Defaults : Resume to the default values

9300K

Red Gain : 

Green Gain : 

Blue Gain : 

Red Offset : 

Green Offset : 

Blue Offset : 

Reset to Defaults : Resume to the default values

User setting :

Red Gain : 

Green Gain : 

Blue Gain : 

Red Offset : 
 Green Offset : 
 Blue Offset : 
 Reset to Defaults : Resume to the default values

Reset All to Defaults : Resume all color temperature settings to the default values.

Hot Key ▶





Hot key 1 : Brightness / Contrast / Inputs / Aspect Ratio/ Zoom / Freeze / PIP Size / PIP Swap / PIP ON/OFF / Saturation / Hue / Backlight / Auto Picture Setup / Image Orientation*** / No Function

Hot key 2 : Brightness / Contrast / Inputs / Aspect Ratio/ Zoom / Freeze / PIP Size / PIP Swap / PIP ON/OFF / Saturation / Hue / Backlight / Auto Picture Setup / Image Orientation*** / No Function

Monochrome Mode ▶ (Effective on V1.26.00.00 or later firmware revision)

- Color
- Red Monochrome
- Green Monochrome
- Blue Monochrome
- Red Only (Display when JP4 position 5-6 is closed)
- Green Only (Display when JP4 position 5-6 is closed)
- Blue Only (Display when JP4 position 5-6 is closed)

Backlight Setup ▶

- B/L Invert :   : Invert for the backlight brightness
- B/L Control : D/A / PWM : Selection for voltage level dimming control / PWM dimming control
- Backlight Frequency :  100 ~ 440Hz in a step of 20
- Light Detector :   : Enable ambient light detector function by using KIT 70220-3
- Min Backlight Level : 0 ~ 50% : Default the minimum backlight adjustment.

Default Setting ▶

- Reset to Factory Defaults ▶ (Activate when JC1 position 4 sets open)
Are you sure ? Yes/No
- Reset to Factory Defaults with (Color Temp.) ▶ (Activate when JC1 position 4 sets open)
Are you sure ? Yes/No
- Save Current Settings as Calibrated Values ▶ (Activate when JC1 position 2 sets closed)
Are you sure ? Yes/No
- Recall Stored Calibrated Values ▶
Are you sure ? Yes/No

: DISPLAY IN ARGB MODE ONLY

+ DISPLAY IN ARGB & COMPONENT MODE ONLY

++ DISPLAY WHEN HD-1000/-2000 CONNECTED

+++ DISPLAY IN COMPOSITE & S-VIDEO MODE ONLY

** The image orientation function is not support under the following conditions :

- PIP
- Component 1 (via CNV2 connector) input.
- Driving with 1366x768 panel
- Zoom

*** Support on V1.26.00.00 firmware or later version.

Once it selects the image orientation on hotkey 1 or hotkey 2, it will cycle through the 4 image orientation modes (Normal/Horizontal Flip/Vertical Flip/Rotate) by pressing each time of hotkey button (SEL UP/SEL DN or + / - buttons).

Not support rotate mode when running with PIP mode or Component input.

Firmware V1.27.00.00 or up

CONNECTORS, PINOUTS & JUMPERS

The various connectors are:

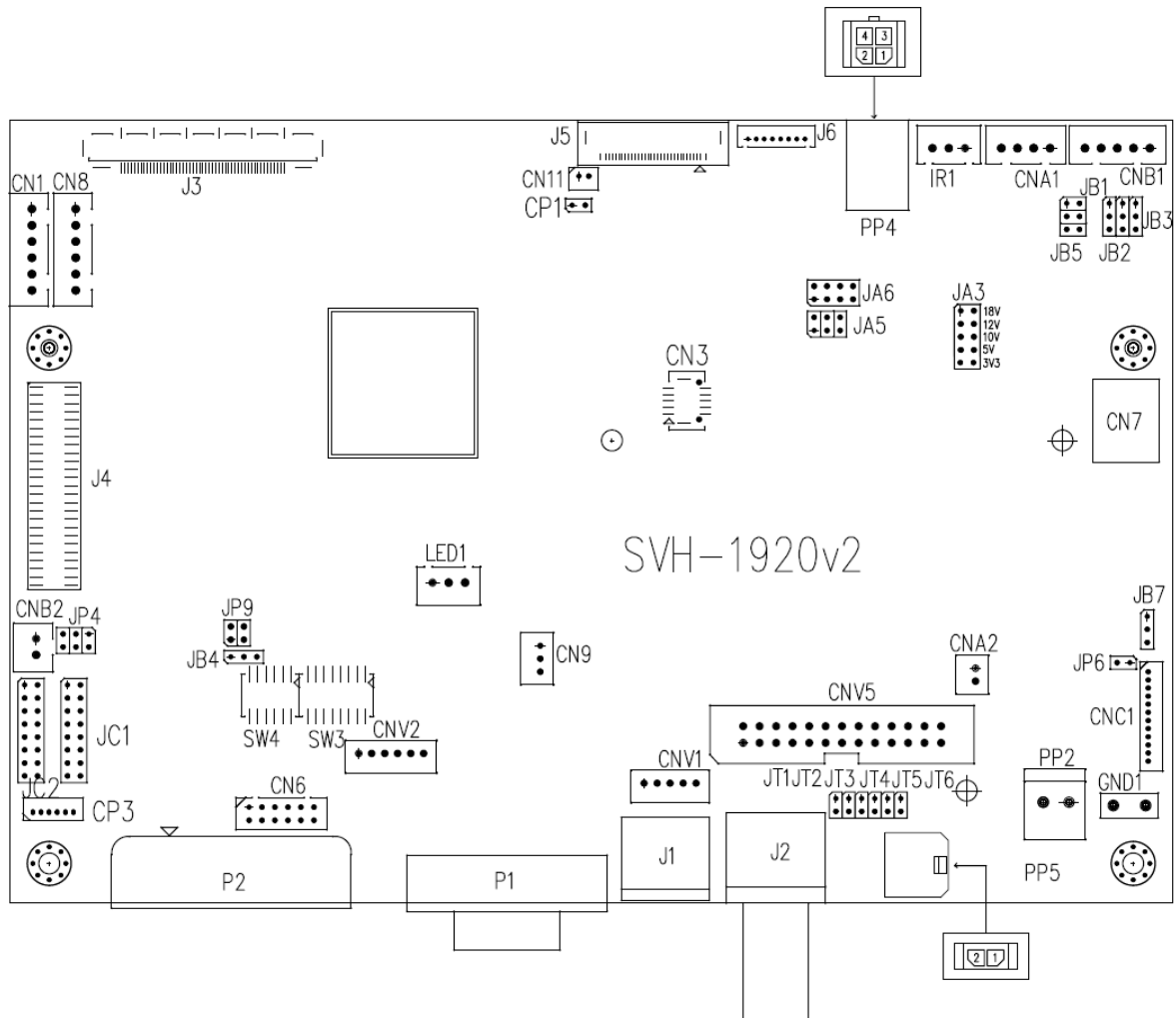

Summary: Connectors

Ref	Purpose	Description
CN1	Second RS-232 serial control	JST 6-way, B6B-XH-A (Matching type : XHP-6)
CN3	Panel connector	HIROSE DF20G-10DP-1V (Matching type : DF20A-10DS-1C)
CN6	VGA 2 input connector	Hirose 12-pin, DF11-12DP-2DSA (Matching type : DF11-12DS-2C)
CN7	Audio board connector	DIL socket header 5x2 right angle (Matching audio Add-on Board P/N 416940020-3)
CN8	RS-232 serial control	JST 6-way, B6B-XH-A (Matching type : XHP-6)
CN9	Ambient light sensor connector	JST 3-way, B3B-PH-K (Matching type : PHR-3)
CNA1	Auxiliary power output	JST 4-way, B4B-XH-A (Matching type : XHP-4)
CNA2	Auxiliary +5VDC output	JST 2 way, B2B-PH-K (Matching type : XHP-2)
CNB1	Backlight inverter	JST 5-way, B5B-XH-A (Matching type : XHP-5)
CNB2	Backlight status input connector	JST 2 way, B2B-XH-A (Matching type : XHP-2)
CNC1	OSD controls	Hirose DF13-12P-1.25H (Mating type : DF13-12S-1.25C) (Matching OSD switch mount cable P/N 426122200-3 (150mm) or 426122210-3 (250mm))
CNV1	Alternate video in (Composite 1 & S-Video 2)	JST 5-way, B5B-PH-K (Matching type : PHR-5) (Matching video cable P/N 426000500-3)
CNV2	Component (YPbPr) video input connector:	JST 6-way, B6B-PH-K (Matching type : PHR-6)
CNV5	Auxiliary video input (Composite 1&2, S-Video 1&2)	Header pin 13x2 (Matching video cable P/N 426000800-3)
J1	S-video 1 in	Mini din 4-way
J2	Composite video 1 in	BNC connector

Specifications subject to change without notice

J3	Panel signal for LVDS panel	JAE FI-RE51S-HF (Matching type : FI-RE51HL)
J4	HD-SDI adaptor board interface connector	2 x 25 ways, 2.54x1.27 header (Matching connector type : DF13-40DS-1.25C) (Matching ribbon cable : P/N 426171100-3)
J5	Display port output for panel connection	I-PEX 20455-030E-12 (Matching type : I-PEX 20454-030T)
J6	Panel power output for Disport port interface panel use.	JS-1147A-08 Top 1.25mm (Matching type : Molex 51021-0800)
IR1	Infra-Red sensor connector	JST 3-way, B3B-XH-A (Matching type : XHP-3)
LED1	Dual color LED connector	JST B3B-XH-A (for 4x-3 or up version) (Matching type : XHP-3)
P1	VGA analog input	DB-15 way high density 3 row
P2	DVI-I (DVI-D or VGA 2) input	DVI-I connector
PP2	Power input (alternative)	DC power Molex 2 pin 0.156" pitch
PP4	External panel power input	Molex 43045-0400 compatible (Matching connector type : Molex 43025-0400 compatible) (Matching power cable : P/N 426013700-3)
PP5	Power input	Molex 43650-0200 compatible (Matching connector type : Molex 43645-0200 compatible) (Matching power cable : P/N 426013800-3)

Summary: Jumpers setting

Ref	Purpose	Note
JA3	Panel power voltage select CAUTION: Incorrect setting can damage panel	See panel voltage setting table 1
JA5	Panel power voltage select CAUTION: Incorrect setting will cause panel damage	See panel voltage setting table 1
JA6	Panel power voltage select CAUTION: Incorrect setting will cause panel damage	See panel voltage setting table 1
JB1	Backlight brightness voltage range	1-2 closed = 5V max 2-3 closed = 3.3V max
JB2	Backlight inverter on/off control – signal level	2-3 = On/Off control signal 'High' = +5V 1-2 = On/Off control signal 'High' = +3.3V Open = On/Off control signal 'High' = Open collector CAUTION: Incorrect setting can damage inverter.
JB3	Backlight inverter on/off control – polarity	1-2 = control signal 'high' = CCFT ON 2-3 = control signal 'low' = CCFT ON
JB4	GPIO pins voltage selection	1-2 = 3.3V 2-3 = 5V
JB5	Backlight control type selection	1-2 = VR/Digital switch mount control 3-4 = Analog backlight brightness - voltage range 0~5V 5-6 = PWM (Pulse Width Modulation) brightness
JB7	Backlight control voltage on CNB1 pin 4 (Function when JB5 sets 1-2 closed)	Open = For OSD switch mount control (Default) 1-2 = 0V 2-3 = 3.3V / 5V controlled by JB1
JC1	Custom configuration	Position 1 : Closed = Disable B/L setup menu Position 2 : Closed = Enable save Current Settings as Calibrated Values on OSD menu Position 3 : Closed = Enable baud rate selection function in programming mode Position 4 : Closed = Hide "Reset to Factory Defaults" and "Reset to Factory Defaults with (Color Temp.)" from OSD menu. Position 7 : Closed = Enable for selection of the "RM-DN5 Assembly" menu on Programming mode.
JC2	Custom configuration	Position 1 : Enable J3 – pin 16 (OP1) controlled by JB4 Position 2 : Enable J3 – pin 17 (OP2) controlled by JB4
JP4	Custom configuration	1-2 closed = Reserved 3-4 closed = On-board programming 5-6 closed = Display "Red/Green/Blue only selection under Monochrome mode on OSD menu
JP6	Input power control	Short = External switch control

Specifications subject to change without notice

		Open = Switch mount control
JP9	Factory use	Default Open
JT1	Composite video-in terminator enable	Open = composite video 1 input is not terminated Close = composite video 1 input is terminated with 75Ω
JT2	S-Video luma-in terminator enable	Open = S-video 1 luma input is not terminated Close = S-video 1 luma input is terminated with 75Ω
JT3	S-Video chroma-in terminator enable	Open = S-video 1 chroma input is not terminated Close = S-video 1 chroma input is terminated with 75Ω
JT4	Component luma-in terminator enable	Open = S-video 2 luma input is not terminated Close = S-video 2 luma input is terminated with 75Ω
JT5	Component Cr-in terminator enable	Open = S-video 2 chroma input is not terminated Close = S-video 2 chroma input is terminated with 75Ω
JT6	Component Cb-in terminator enable	Open = composite video 2 input is not terminated Close = composite video 2 input is terminated with 75Ω
SW3	Panel & function selection	See table 2
SW4	Panel & function selection	See table 3

Table 1 : Panel voltage setting table :



Input voltage via PP2, PP5	Panel Voltage	JA3	JA5	JA6	Jumper on board
12VDC	3.3V	3V3 closed	1-3 & 2-4	1-3 & 2-4	
	5V	5V closed	1-3 & 2-4	1-3 & 2-4	
	12V	OPEN	1-3 & 2-4	5-7 & 6-8	

CAUTION: Incorrect setting can damage panel & controller

Input voltage via PP2, PP5	Panel Voltage	JA3	JA5	JA6	Jumper on board
24VDC**	3.3V	3V3 closed	1-3 & 2-4	1-3 & 2-4	
	5V	5V closed	1-3 & 2-4	1-3 & 2-4	
	10V	10V closed	1-3 & 2-4	3-5 & 4-6	
	12V	12V closed	1-3 & 2-4	3-5 & 4-6	
	18V	18V closed	1-3 & 2-4	3-5 & 4-6	

CAUTION: Incorrect setting can damage panel & controller

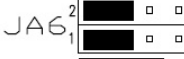
**** Ensure that the backlight inverter supports 24V operation prior to connecting a 24VDC input. Because CNA1 pin 1 and CNB1 pin 2 will output 24VDC if input 24VDC via PP2/PP3 or PP5.**

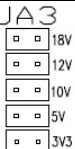
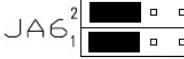
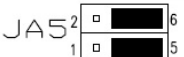
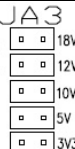
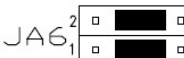
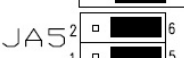
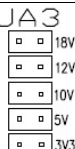
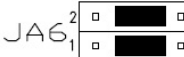
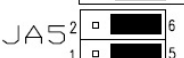
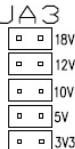
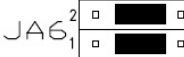
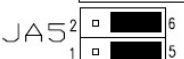
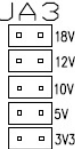
Input voltage via PP4	Panel Voltage	JA3	JA5	JA6	Jumper on board
3.3 / 5 / 12 / 18VDC*	3.3V	OPEN	3-5 & 4-6	1-3 & 2-4	  
	5V	OPEN	3-5 & 4-6	1-3 & 2-4	  
	10V	OPEN	3-5 & 4-6	3-5 & 4-6	  
	12V	OPEN	3-5 & 4-6	3-5 & 4-6	  
	18V	OPEN	3-5 & 4-6	3-5 & 4-6	  

* Maximum current for 3.3V, 5V = 7A, Maximum current for 12V = 5A, Maximum current for 18V = 3.5A

JA3, JA5 & JA6 location on board : (Please pay attention to the jumper settings on JA3, JA5 & JA6 which are red in color)

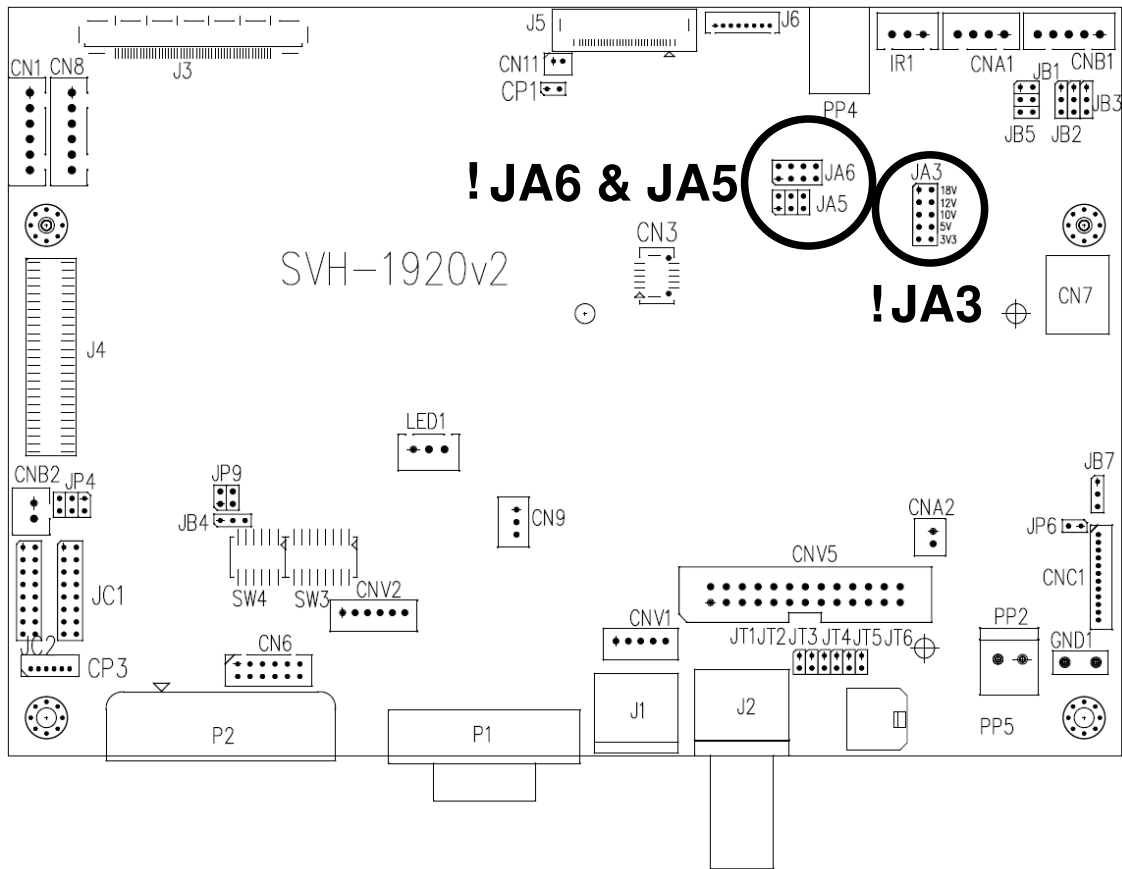

Table 2 : DIP Switch selection – SW3

Pos #1	Pos #2	Pos #3	Pos.#4	Description	Panel resolution
For WUXGA panels					
OFF	ON	ON	OFF	LG LM260WU1-SLB1	1920x1200
ON	ON	ON	OFF	LG LM240WU2-SLA1	1920x1200
OFF	OFF	OFF	OFF	Sharp LQ445D3LZ19	1920x1080
ON	OFF	OFF	OFF	Samsung LTA460H2-L02	1920x1080
OFF	ON	OFF	OFF	Sharp LQ170M1LZ04	1920x1200
ON	ON	OFF	OFF	Samsung LTA700HH-LH1 (1 st trial testing)	1920x1080
OFF	OFF	ON	OFF	Samsung LTA700HH-LH1 (2 nd trial testing)	1920x1080
OFF	OFF	ON	ON	AU Optronics P645HW03 V0 (1920x1080)	1920x1080
OFF	OFF	ON	ON	AU Optronics P645HW03 V0	1920x1080
OFF	ON	ON	ON	Samsung ASI545FB01-0 (OLED)*	1920x1080
For UXGA panels					
OFF	OFF	OFF	OFF	Fujitsu FLC59UXC8V-02A	1600x1200
ON	OFF	OFF	OFF	Samsung LTM213U6-L01	1600x1200
For WXGA panels					
OFF	OFF	OFF	OFF	LG LC420W02-A4	1366x768
ON	OFF	OFF	OFF	Sharp LQ315T3LZ24	1366x768
ON	ON	OFF	OFF	Samsung LTA320W2-L01 / LTA230W1-L02	1366x768
ON	ON	ON	ON	NEC NL12876BC26-21 / Samsung LTM170W1-L01	1280x768
OFF	ON	ON	ON	CHI MEI N15414-L01	1280x800
OFF	OFF	ON	OFF	AU Optronics M190PW01	1440x900
OFF	OFF	ON	ON	Sharp LQ072K1LA03	1280x768
For SXGA panel					
OFF	OFF	OFF	OFF	Sharp LQ181E1LW31	1280x1024
ON	OFF	OFF	OFF	AU Optronics M170EN05	1280x1024
ON	ON	OFF	OFF	Sharp LQ121S1LG81*	800x600
For XGA panel					
OFF	OFF	OFF	OFF	Sharp LQ150X1LGN2A Sharp LQ150X1LGB1	1024x768 1024x768
For SVGA panel					
OFF	OFF	OFF	OFF	Sharp LQ121S1DG11/41 Toshiba LTM08C351	800x600 800x600
For WVGA panel					
OFF	OFF	OFF	OFF	NEC NL8048BC24-01	800x480
ON	OFF	OFF	OFF	Kyocera TCG085WV1AB-G00	800x480
ON	OFF	ON	OFF	Sharp LQ070Y3LG4A	800x480
For VGA panel					
OFF	OFF	OFF	OFF	Sharp LQ104V1DG51	640x480
ON	OFF	OFF	OFF	Sharp LQ104V1DG21 Kyocera TCG075VG2AC-G00	640x480 640x480
Others					
OFF	ON	OFF	OFF	AU Optronics M201EW02 V8	1680x1050
ON	OFF	OFF	ON	Samsung LTM201M1-L01	1680x1050
OFF	OFF	ON	ON	Hitachi TX48D02VM0BAA / JDI TX48D02VM0BAA*	1680x1050
OFF	OFF	ON	OFF	Samsung LT1430LA01	1920x480
OFF	ON	ON	OFF	NEC NL10260BC19-01D	1024x600
ON	ON	ON	OFF	AU Optronics M200RW01 Samsung LTM200KP01	1600x900 1600x900

Remark :

* Effective on V1.26.00.00 version or up.

Remark : The above panel timings are generated based on the panel specification. Some of the panel timings settings may not exactly to match the panel model we specified in this table.

Pos #5	Pos #6	Pos #7	Description
OFF	OFF	OFF	WUXGA
ON	OFF	OFF	UXGA
OFF	ON	OFF	SXGA
ON	ON	OFF	WXGA
OFF	OFF	ON	XGA
ON	OFF	ON	SVGA
OFF	ON	ON	VGA
ON	ON	ON	WVGA / Others

Pos. #8	Video lock	ON – Disable : Always fix the output be 60Hz. OFF – Enable : The output refresh rate locks to the input for 50Hz / 60Hz mode (other resolution lock the output be 60Hz.)
---------	------------	--

Specifications subject to change without notice

Table 3 : DIP switch selection – SW4

Pos. #	Function	Description
1	Reserved	Reserved
2	Panel pixel format	OFF : Double Pixel ON : Single Pixel
3	Panel selection	Default ON : Single / Double pixel LVDS panel (controlled by SW4 position 2)
4	LVDS data mapping select (Refer to Table 2)	If SW4 position 5 = OFF (8 bit) OFF : Mapping B ON : Mapping A Please adjust to get the correct picture. See as Appendix I for details of mapping of A and B. If SW4 position 5 = ON (10 bit) OFF : JEIDA (LVDS panel) ON : VESA (LVDS panel) Please adjust to get the correct picture. See as Appendix I for details of mapping of VESA and JEIDA.
5	Output LVDS display mode selection	OFF : 8 bit ON : 10 bit
6	LVDS mapping swap	OFF : Normal ON : Swap

Support "Resolution default by EDID" for different resolution panel.

The controller will set the preferred timing based off the dip switch setting (SW3 position 1-7) selection, but also be able to go higher to 1920x1200. For example, if the panel is a 1024x768 and the dip switch setting are set for 1024x768. The preferred EDID resolution should be 1024x768. It should also have the capability to set the max resolution to 1920x1200.

* This function is only effective on V1.26.00.00 or later firmware revision.

CN1 – Slave RS-232 serial control: JST B6B-XH-A (Matching type : XHP-6)

PIN	SYMBOL	DESCRIPTION
1	EXT_MSTR2_SCL	Reserved
2	EXT_MSTR2_SDA	Reserved
3	VCC	+5V
4	TXD	RS-232 Tx data
5	GND	Ground
6	RXD	RS-232 Rx data

CN3 – Panel connector: HIROSE DF20G-10DP-1V (Matching type : DF20A-10DS-1C)

PIN	SYMBOL	DESCRIPTION
1	OP1	Reserved
2	OP2	Reserved
3	OP3	Reserved
4	OP4	Reserved
5	IP1	Reserved
6	IP2	Reserved
7	IP3	Reserved
8	IP4	Reserved
9	EXT_MSTR2_SDA	Reserved
10	EXT_MSTR2_SCL	Reserved

CN6 - VGA 2 input connector : Hirose 12-pin, DF11-12DP-2DSA (Matching type : DF11-12DS-2C)

PIN	SYMBOL	DESCRIPTION
1	R	Red, analog
2	DDC_5V	+5V power supply for DDC (optional)
3	G	Green, analog
4	GND	Ground
5	B	Blue, analog
6	GND	Ground
7	HS	Horizontal sync or composite sync, input
8	GND	Ground
9	VS	Vertical sync, input
10	DDC_SCL	DDC serial clock
11	NC	No connection
12	DDC_SDA	DDC serial data

CN7 - Audio connector: DIL socket header 5x2 right angle

PIN	SYMBOL	DESCRIPTION
1	VCC	Audio board logic power supply, +5V
2	VOLSEL0	Reserved
3	VOLSEL1	Reversed
4	TUNAUSEL	Reserved
5	CLK/CNT	Reserved
6	GND	Ground
7	+12V/+24V	Audio board power supply, +12V/+24V
8	NC	No connection
9	NC	No connection
10	GND	Ground

CN8 – RS-232 serial control: JST B6B-XH-A (Matching type : XHP-6)

PIN	SYMBOL	DESCRIPTION
1	SDATA	Reserved
2	SCLK	Reserved
3	VCC	+5V
4	TXD	RS-232 Tx data
5	GND	Ground
6	RXD	RS-232 Rx data

CN9 – Ambient light sensor connector : JST B3B-PH-K (Matching type : PHR-3)

PIN	SYMBOL	DESCRIPTION
1	GND	Ground
2	VCC_5V	VCC 5V
3	ALSF	Ambient light sensing feedback

CN11 – SPDIF audio output connector : JST B3B-PH-K (Matching type : PHR-3)

PIN	SYMBOL	DESCRIPTION
1	SPDIF	SPDIF Digital audio output
2	GND	Ground

Specifications subject to change without notice

CNA1 - Auxiliary power output: JST B4B-XH-A (Matching type : XHP-4)

PIN	SYMBOL	DESCRIPTION
1	AUX 12V / 24V	+12V / +24V DC
2	GND	Ground
3	GND	Ground
4	AUX 5V	+5V DC, 500mA max

CNA2 - Auxiliary power output: JST B2B-PH-K (Matching type : XHP-2)

PIN	SYMBOL	DESCRIPTION
1	Vcc 5V	+5V DC, 500mA max with fuse
2	GND	Ground

CNB1 – Backlight inverter connector: JST B5B-XH-A (Matching type : XHP-5)

PIN	SYMBOL	DESCRIPTION
1	GND	Ground
2	VBKL	+12V / +24V DC, backlight power supply
3	BLCTRL	On/Off control (enable) – see JB2 & JB3
4	BVR_WIP	Brightness VR – WIP
5	BVR_A	Brightness VR A

CNB2 – Backlight status input inverter connector: JST B2B-XH-A (Matching type : XHP-2)

PIN	SYMBOL	DESCRIPTION
1	BL_STATUS	Backlight status (Normal = High)
2	GND	Ground

CNC1 – OSD switch mount control, Hirose DF13-12P-1.25H (Mating type : DF13-12S-1.25C)

PIN	SYMBOL	DESCRIPTION
1	PSWIN	Power button A
2	SW_ON	Power button B
3	BVR_A	Backlight Brightness VR pin A
4	BVR_WIP	Backlight Brightness R pin WIP
5	BVR_B	Backlight Brightness VR pin B (470 ohm resistor to +5V Vcc)
6	GND	Ground
7	MENU	OSD menu
8	-/LEFT	OSD -/Left
9	+ /RIGHT	OSD +/Right
10	SEL_DN	OSD Select down
11	SEL_UP	OSD Select up
12	NC	No connection

The VR for brightness depends on the inverter. The main power load for On/Off is handled by a relay on the controller.

CNV1 – Alternate Video in input, JST B5B-PH-K (Matching type : PHR-5)

PIN	DESCRIPTION
1	S-Video : Chroma in
2	S-Video : Luma in
3	Ground
4	Ground
5	Composite video in

CNV2 – Component (YPbPr) video input connector: JST 6-way, B6B-PH-K (Matching type : PHR-6)

PIN	SYMBOL	DESCRIPTION
1	A_Y1	Luma in / Green in
2	GND	Ground
3	A_Pb1	Pb in / Blue in
4	GND	Ground
5	A_Pr1	Pr in / Red in
6	GND	Ground

CNV5 – Auxiliary Video input connector, DIL socket header 13x2

PIN	DESCRIPTION
1	S-Video : Chroma in
2	Ground
3	S-Video : Luma in
4	Ground
5	Composite video in
6	Ground
7	No connection
8	Ground
9	No connection
10	Ground
11	No connection
12	Ground
13	S-Video_2 : Chroma in
14	Ground
15	S-Video_2 : Luma in
16	Ground
17	Composite video in_2
18	Ground
19	No connection
20	Ground
21	No connection
22	Ground
23	No connection
24	Ground
25	No connection
26	Ground

IR1 – Infra-Red sensor connector: JST B3B-XH-A (Matching type : XHP-3)

PIN	SYMBOL	DESCRIPTION
1	GND	Ground
2	STDBY_Vcc	Stand by voltage
3	IR Data	IR data

J3 – LVDS output connector: JAE FI-RE51S-HF (Matching type : JAE FI-RE51HL)

PIN	SYMBOL	DESCRIPTION
1	VLCD HV	Panel power supply (+12V / 18V) (selected by JA3, JA5 & JA6)
2	VLCD HV	Panel power supply (+12V / 18V) (selected by JA3, JA5 & JA6)
3	VLCD HV	Panel power supply (+12V / 18V) (selected by JA3, JA5 & JA6)
4	VLCD HV	Panel power supply (+12V / 18V) (selected by JA3, JA5 & JA6)
5	VLCD HV	Panel power supply (+12V / 18V) (selected by JA3, JA5 & JA6)
6	VLCD LV	Panel power supply (3,3V/5V) (selected by JA3, JA5 & JA6)
7	VLCD LV	Panel power supply (3,3V/5V) (selected by JA3, JA5 & JA6)
8	VLCD LV	Panel power supply (3,3V/5V) (selected by JA3, JA5 & JA6)
9	VLCD LV	Panel power supply (3,3V/5V) (selected by JA3, JA5 & JA6)
10	VLCD LV	Panel power supply (3,3V/5V) (selected by JA3, JA5 & JA6)
11	GND	Ground
12	GND	Ground
13	GND	Ground
14	GND	Ground
15	GND	Ground
16	OP1	-
17	OP2	-
18	NC	No function
19	NC	No function
20	GND	Ground
21	GND	Ground
22	LVDS_OUT1_A4+	Positive differential LVDS data bit A4
23	LVDS_OUT1_A4-	Negative differential LVDS data bit A4
24	LVDS_OUT1_A3+	Positive differential LVDS data bit A3
25	LVDS_OUT1_A3-	Negative differential LVDS data bit A3
26	GND	Ground
27	LVDS_OUT1_AC+	Positive LVDS clock for A channel
28	LVDS_OUT1_AC-	Negative LVDS clock for A channel
29	GND	Ground
30	LVDS_OUT1_A2+	Positive differential LVDS data bit A2
31	LVDS_OUT1_A2-	Negative differential LVDS data bit A2

Specifications subject to change without notice

32	LVDS_OUT1_A1+	Positive differential LVDS data bit A1
33	LVDS_OUT1_A1-	Negative differential LVDS data bit A1
34	LVDS_OUT1_A0+	Positive differential LVDS data bit A0
35	LVDS_OUT1_A0-	Negative differential LVDS data bit A0
36	GND	Ground
37	LVDS_OUT1_B4+	Positive differential LVDS data bit B4
38	LVDS_OUT1_B4-	Negative differential LVDS data bit B4
39	LVDS_OUT1_B3+	Positive differential LVDS data bit B3
40	LVDS_OUT1_B3-	Negative differential LVDS data bit B3
41	GND	Ground
42	LVDS_OUT1_BC+	Positive LVDS clock for B channel
43	LVDS_OUT1_BC-	Negative LVDS clock for B channel
44	GND	Ground
45	LVDS_OUT1_B2+	Positive differential LVDS data bit B2
46	LVDS_OUT1_B2-	Negative differential LVDS data bit B2
47	LVDS_OUT1_B1+	Positive differential LVDS data bit B1
48	LVDS_OUT1_B1-	Negative differential LVDS data bit B1
49	LVDS_OUT1_B0+	Positive differential LVDS data bit B0
50	LVDS_OUT1_B0-	Negative differential LVDS data bit B0
51	GND	Ground

J4 – HD-SDI adaptor board interface connector: 2 x 25 ways, 2.54x1.27 header
(Matching ribbon cable : P/N 426171100-3)

PIN	SYMBOL	DESCRIPTION
1	GND	Ground
2	GND	Ground
3	CbCr0 (Input)	CbCr0 (Input)
4	Y0 (Input)	Y0 (Input)
5	CbCr1 (Input)	CbCr1 (Input)
6	Y1 (Input)	Y1 (Input)
7	CbCr2 (Input)	CbCr2 (Input)
8	Y2 (Input)	Y2 (Input)
9	CbCr3 (Input)	CbCr3 (Input)
10	Y3 (Input)	Y3 (Input)
11	CbCr4 (Input)	CbCr4 (Input)
12	Y4 (Input)	Y4 (Input)
13	CbCr5 (Input)	CbCr5 (Input)
14	Y5 (Input)	Y5 (Input)
15	CbCr6 (Input)	CbCr6 (Input)
16	Y6 (Input)	Y6 (Input)
17	CbCr7 (Input)	CbCr7 (Input)
18	Y7 (Input)	Y7 (Input)
19	CbCr8 (Input)	CbCr8 (Input)
20	Y8 (Input)	Y8 (Input)
21	CbCr9 (Input)	CbCr9 (Input)
22	Y9 (Input)	Y9 (Input)
23	N.C	No connection
24	N.C	No connection
25	VCC(5V)	VCC(5V)
26	VCC (5V)	VCC (5V)
27	CLOCK (Input)	CLOCK (Input)
28	SCLK_TCK(control pin)	SCLK_TCK(control pin)
29	GND	Ground
30	SDIN_TDI(control pin)	SDIN_TDI(control pin)
31	Field (Input)	Field (Input)
32	SDOUT_TDO(control pin)	SDOUT_TDO(control pin)
33	V sync (Input)	V sync (Input)
34	CS_TMS(control pin)	CS_TMS(control pin)
35	H sync (Input)	H sync (Input)
36	GND	Ground
37	DE (Input)	DE (Input)
38	N.C	No connection
39	N.C	No connection
40	N.C	No connection
41	HSDI_LOCK (control pin)	HSDI_LOCK (control pin)
42	N.C	No connection
43	GND	Ground
44	GND	Ground
45	N.C	No connection
46	N.C	No connection

Specifications subject to change without notice

47	N.C	No connection
48	HDSDI_IPSEL (control pin)	HDSDI_IPSEL (control pin)
49	Videomux_CAB (control pin)	Video mux detected pin
50	HDSDI_CAB (control pin)	HDSDI_CAB (control pin)

J5 – Display port output for panel connector: I-PEX 20455-030E-12

(Matching type : I-PEX 20454-030T)

PIN	SYMBOL	DESCRIPTION
1	GND	Ground
2	GND	Ground
3	GND	Ground
4	GND	Ground
5	VLCD_LV	Panel power supply (3,3V/5V) (selected by JA3, JA5 & JA6)
6	VLCD_LV	Panel power supply (3,3V/5V) (selected by JA3, JA5 & JA6)
7	VLCD_LV	Panel power supply (3,3V/5V) (selected by JA3, JA5 & JA6)
8	VLCD_LV	Panel power supply (3,3V/5V) (selected by JA3, JA5 & JA6)
9	NC	No connection
10	DP_PWR	Power for connector (3.3 V 500 mA)
11	Return	Return for Power
12	Hot Plug	Hot Plug Detect
13	AUX CH (n)	Auxiliary Channel (negative)
14	GND	Ground
15	AUX CH (p)	Auxiliary Channel (positive)
16	CONFIG2	connected to Ground
17	CONFIG1	connected to Ground
18	ML_Lane 3 (n)	Lane 3 (negative)
19	GND	Ground
20	ML_Lane 3 (p)	Lane 3 (positive)
21	ML_Lane 2 (n)	Lane 2 (negative)
22	GND	Ground
23	ML_Lane 2 (p)	Lane 2 (positive)
24	ML_Lane 1 (n)	Lane 1 (negative)
25	GND	Ground
26	ML_Lane 1 (p)	Lane 1 (positive)
27	ML_Lane 0 (n)	Lane 0 (negative)
28	GND	Ground
29	ML_Lane 0 (p)	Lane 0 (positive)
30	GND	Ground

J6 – Panel power output: JS-1147A-08 Top 1.25mm

(Matching type : Molex 51021-0800)

PIN	SYMBOL	DESCRIPTION
1	PVLCD_Low (3,3V/5V)	Panel power supply (3,3V/5V) (selected by JA3, JA5 & JA6)
2	PVLCD_Low (3,3V/5V)	Panel power supply (3,3V/5V) (selected by JA3, JA5 & JA6)
3	GND	Ground
4	GND	Ground
5	GND	Ground
6	PVLCD_High (12V/18V)	Panel power supply (+12V / 18V) (selected by JA3, JA5 & JA6)
7	PVLCD_High (12V/18V)	Panel power supply (+12V / 18V) (selected by JA3, JA5 & JA6)
8	PVLCD_High (12V/18V)	Panel power supply (+12V / 18V) (selected by JA3, JA5 & JA6)

LED1 – Status LED connector: 3-pin header

PIN	DESCRIPTION
1	Green LED pin (anode)
2	LED pin common (cathode)
3	Red LED pin (anode)

P1 - Analog VGA in - 15 way connector

PIN	SYMBOL	DESCRIPTION
1	PCR	Red, analog
2	PCG	Green, analog
3	PCB	Blue analog
4	ID2	Reserved for monitor ID bit 2 (grounded)
5	DGND	Digital ground
6	AGND	Analog ground red
7	AGND	Analog ground green
8	AGND	Analog ground blue
9	DDC_5V	+5V power supply for DDC (optional)
10	DGND	Digital ground

Specifications subject to change without notice

11	ID0	Reserved for monitor ID bit 0 (grounded)
12	DDC_SDA	DDC serial data
13	HS_IN	Horizontal sync or composite sync, input
14	VS_IN	Vertical sync, input
15	DDC_SCL	DDC serial clock

P2 – DVI-I input

PIN	SYMBOL	DESCRIPTION
1	/RX2	TMDS Data 2-
2	RX2	TMDS Data 2+
3	GND	Digital Ground
4	NC	No connection
5	NC	No connection
6	DDC_CLK	DDC Clock
7	DDC_DAT	DDC Data
8	VS_IN	Analog vertical Sync
9	/RX1	TMDS Data 1-
10	RX1	TMDS Data 1+
11	GND	Digital Ground
12	NC	No connection
13	NC	No connection
14	DDC_5V	+5V power supply for DDC (optional)
15	GND	Ground (+5, Analog H/V Sync)
16	HPD	Hot Plug Detect
17	/RX0	TMDS Data 0-
18	RX0	TMDS Data 0+
19	GND	Digital Ground
20	NC	No connection
21	NC	No connection
22	GND	Digital Ground
23	RXC	TMDS Clock+
24	/RXC	TMDS Clock-
C1	R	Red
C2	G	Green
C3	B	Blue
C4	HS_IN	Analog horizontal sync
C5	GND	Ground
C6	NC	No connection

PP2 – Alternate 12V/24VDC input power supply

PIN	DESCRIPTION
1	+12VDC / +24VDC in
2	Ground

PP4 – External panel power input

PIN	DESCRIPTION
1	External panel power
2	Ground
3	External panel power
4	Ground

PP5 – 12V/24VDC input power supply

PIN	DESCRIPTION
1	+12V / +24VDC
2	Ground

CONTROLLER DIMENSIONS

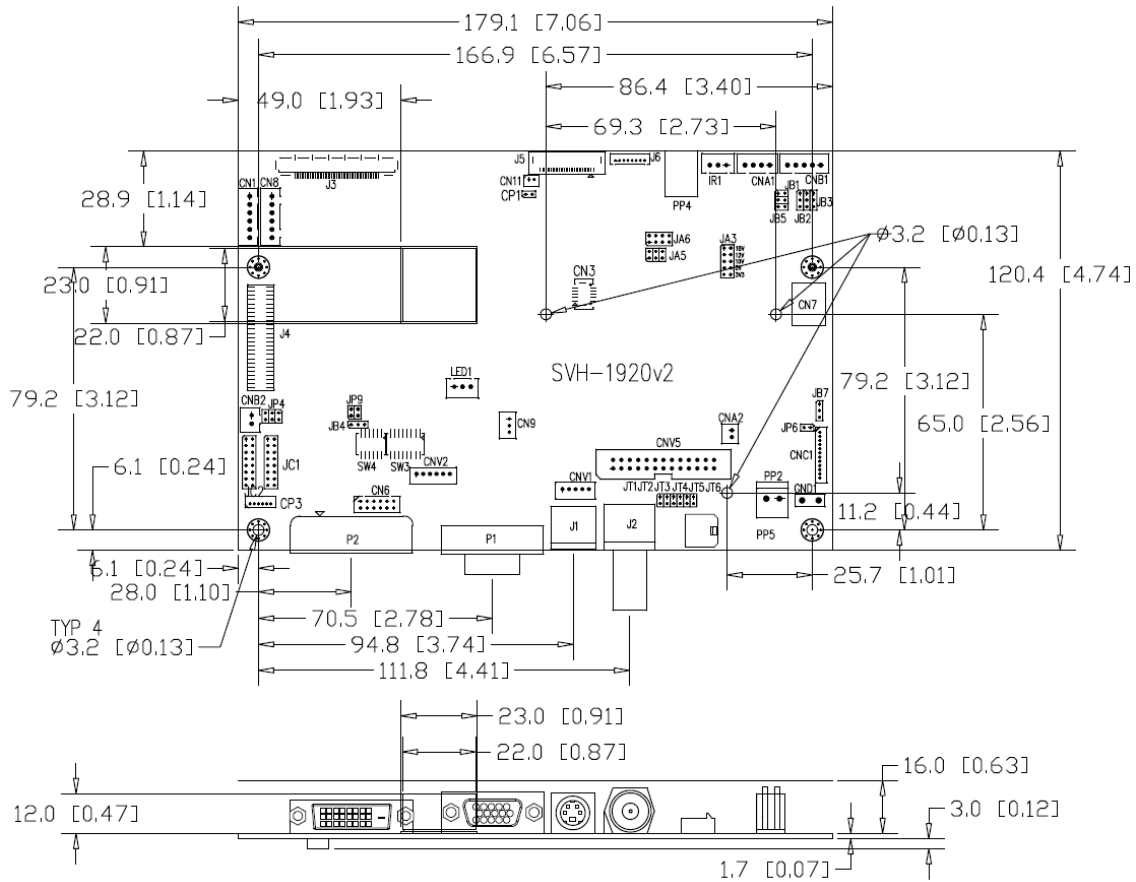

Ready-made 3D Pro-E (SLDPRT) drawing files - Save time and effort for your system volumetric analysis design. Includes jpg file previews. Please go to download at <http://www.digitalview.com/products/svh-1920v2-lcd-controller>

The maximum thickness of the controller is 20.7mm with or without video add-on board (measured from bottom of PCB to top of components, including any underside components & leads). We recommend clearances of:

- 5mm from bottom of PCB - if mounting on a metal plate we also recommend a layer of suitable insulation material is added to the mounting plate surface.
- 10mm above the components
- 3~5mm around the edges

Any of the holes shown above can be used for mounting the PCB, they are 3.2mm in diameter.

CAUTION: Ensure adequate insulation is provided for all areas of the PCB with special attention to high voltage parts such as the inverter.

APPLICATION NOTES

USING THE CONTROLLER WITHOUT BUTTONS ATTACHED

This is very straightforward:

- Firstly setup the controller/display system with the buttons. With controls attached and display system active make any settings for colour, tint and image position as required then switch everything off.
- Remove the control switches, the 12-way (CNC1) cable.
- Use a jumper or similar to connect pins 1 & 2 on CNC1, this will fix the board On.
- Refer to inverter specifications for details as to fixing brightness to a desired level, this may require a resistor, an open circuit or closed circuit depending on inverter.

Summary: On CNC1 the only pins that are used are for On/Off and Brightness (if controller mounted inverter is used). On CNC1 the pins are for momentary type buttons so it doesn't matter that no buttons are attached.

INVERTER CONNECTION

There are potentially 3 issues to consider with inverter connection:

- Power
- Enable
- Brightness

Please read the following sections for a guide to these issues.

Inverter Power: As per the table for CNB1 pin 1 is ground and pin 2 provides 12V/24V DC. This should be matched with the inverter specification: see table.

CNB1	
PIN	DESCRIPTION
1	Ground
2	+12V/+24VDC

Remark: For higher power inverter, more current (for 12V/24V) can be taken from CNA1 pin 1.

Enable: This is a pin provided on some inverters for On/Off function and is used by this panel controller for VESA DPMS compliance. If the inverter does not have an enable pin or the enable pin is not used then DPMS will not be operational. Pin 3 should be matched to the inverters specification for the 'enable' or 'disable' pin.

CNB1	
PIN	DESCRIPTION
3	Enable

Further, jumpers JB2 & JB3 should be set to match the inverters specification for the enable pin power and High or Low setting: see table.

Ref	Purpose	Note
JB2	Inverter enable voltage	1-2 H = 3.3VV, 2-3 H = 5V (Vcc), OPEN H = open collector
JB3	Inverter control	1-2 H = On, 2-3 L = On

Brightness: There are various methods for brightness control and it is important to consider the specifications for the inverter to be used. Generally the situation is:

- Brightness can control by using a resistor or VR (Variable Resistor).
- Brightness controlled by adding a circuit such as PWM (Pulse Width Modulation).
- No adjustment of brightness is possible.

CNB1 pins 4 & 5 are available for connecting to an inverter or circuit where VR control is supported.

CNB1	
PIN	DESCRIPTION
4	VR WIP
5	VR A

This can then be matched with function controls connected to CNC1 pins 4 & 3 or 5: see table.

CNC1	
PIN	DESCRIPTION
3	VR A
4	VR WIP
5	VR B

Specifications subject to change without notice

Design Guideline for making VR circuitry :

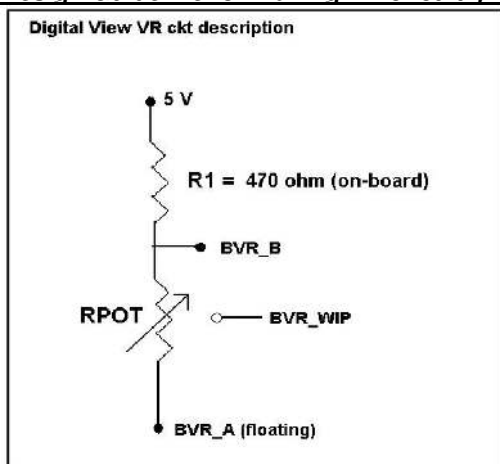

Signal description / Notes :

- 1) R1 : 470ohm on board
- 2) RPOT is an external potentiometer (in-line dip style) that can be plugged directly into CNC1 pins 3,4,5. RPOT must be supplied / installed by user.
- 3) BVR_B : Voltage tapped from “top” of potentiometer, the node of R1 and RPOT.
- 4) BVR_WIP : Voltage tapped from wiper arm of RPOT.
- 5) BVR_A : Voltage tapped from “bottom” of RPOT.

Note : BVR_A voltage is left floating on the controller board. To use this circuit, you need to tie this point to a potential (usually GND, available at CNC1 pin 6).

CNB1 – Backlight inverter connector: JST B5B-XH-A (Matching type : XHP-5)

PIN	SYMBOL	DESCRIPTION
1	GND	Ground
2	VBKL	+12V/24VDC, backlight power supply
3	BLCTRL	On/Off control (enable) – see JB2 & JB3
4	BVR_WIP	Brightness VR - WIP
5	BVR_A	Brightness VR A

CNC1 – Control switch, JST B12B-XH-A (Matching type : XHP-12)

PIN	SYMBOL	DESCRIPTION
1	PSWIN	Power button A
2	SW_ON	Power button B
3	BVR_A	Backlight Brightness VR pin A
4	BVR_WIP	Backlight Brightness R pin WIP
5	BVR_B	Backlight Brightness VR pin B (470 ohm resistor to +5V Vcc)
6	GND	Ground
7	MENU	OSD menu
8	-/LEFT	OSD -/Left
9	+ /RIGHT	OSD +/Right
10	SEL_DN	OSD Select down
11	SEL_UP	OSD Select up
12	NC	No connection

The VR for brightness depends on the inverter. The main power load for On/Off is handled by a relay on the controller.

Example for circuit design :

- 1.) Choose RPOT = 10K
- 2.) Tie BVR_A to GND
- 3.) Circuit analysis gives BVR_WIP as the following (see Figure 1)

$$BVR_WIP = 5 \times (Rbc/10.47)$$

where BVR_WIP is in Volts.
And Rbc is the resistance from the wiper arm to bottom of pot in Kohms.

To evaluate, plug in different values of Rbc :

Rbc	BVR_WIP
0	0 V
2.5 K	1.2 V
5 K	2.4 V
7.5 K	3.6 V
10 K	4.8 V

So this circuit could provide Brightness adjust voltage ranging from 0V to 5V.

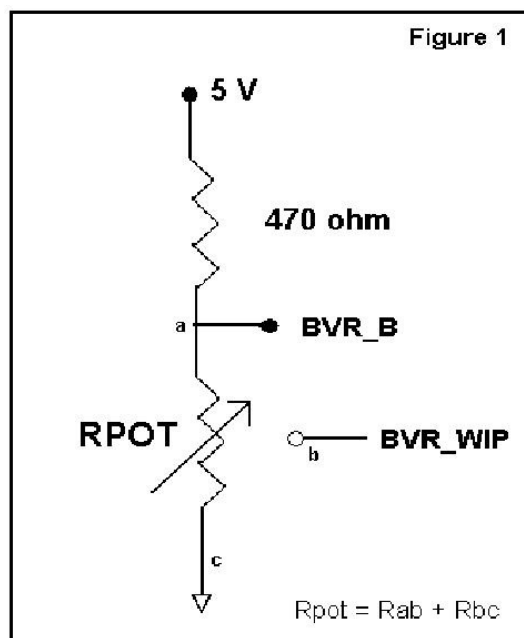

Specifications subject to change without notice

TROUBLESHOOTING

General

A general guide to troubleshooting a flat panel display system it is worth considering the system as separate elements, such as:

- Controller (jumpers, PC settings)
- Panel (controller, cabling, connection, panel, PC settings)
- Backlight (inverter, cabling, backlight tubes)
- Cabling
- Computer system (display settings, operating system)

Through step by step cross checking with instruction manuals and a process of elimination to isolate the problem it is usually possible to clearly identify the problem area.

No image:

- If the panel backlight is not working it may still be possible to just see some image on the display.
- A lack of image is most likely to be caused by incorrect connection, lack of power, failure to provide a signal or incorrect graphic card settings.

Image position:

If it is impossible to position the image correctly, i.e. the image adjustment controls will not move the image far enough, then test using another graphics card. This situation can occur with a custom graphics card that is not close to standard timings or if something is in the graphics line that may be affecting the signal such as a signal splitter (please note that normally a signal splitter will not have any adverse effect).

Image appearance:

- A faulty panel can have blank lines, failed sections, flickering or flashing display
- Incorrect graphics card refresh rate, resolution or interlaced mode will probably cause the image to be the wrong size, to scroll, flicker badly or possibly even no image.
- Incorrect jumper settings on the controller may cause everything from total failure to incorrect image. CAUTION: Do not set the panel power input incorrectly.
- Sparkling on the display: faulty panel signal cable.
- Found "Loading" message displayed on screen message at DVI input indicates the unstable DVI source detected (especially connected to DVI splitter) causing flashing image.
- No image found when non-matching video system signal input. For example, the condition of setting NTSC video system (under OSD menu > Video System (SD)) and input PAL signal.

Backlight:

Items to check include: Power input, Controls, Inverter and Tubes generally in this order.

If half the screen is dimmer than the other half:

- Check cabling for the inverter.
- For a specific backlight tube check the AC pins orientation (CAUTION: Never reverse any DC power pins).

Also:

- If adjusting brightness control has no effect the chances are that the VR rating or method of adjusting brightness is not compatible or correctly connected to the inverter.
- If system does not power down when there is a loss of signal

Continued failure:

If unit after unit keeps failing consider and investigate whether you are short circuiting the equipment or doing something else seriously wrong.

Generally after common sense issues have been resolved we recommend step by step substitution of known working parts to isolate the problem.

SPECIFICATIONS

Panel compatibility	Compatible with 1920x1200, 1920x1080, 1680x1050, 1600x1200, 1440x900 1366x768, 1280x1024, 1024x768, 800x600 & 640x480 resolutions of TFT LCD panels. A specified BIOS and some factory adjustment may be required for individual panel timings.
No. of colours	Up to 3 x 8 bit providing 16.7 million colours.
Panel power	DC 3.3V, 5V, 10V, 12V, 18V
Panel signal	LVDS
Vertical refresh rate	60Hz at 1920x1200, 60Hz at 1920x1080, 60Hz at UXGA and up to 75Hz other lower resolution
Display clock maximum	165MHz
ADC clock maximum	195 MHz
DVI differential input clock maximum	165MHz
Graphics formats	Standard VESA VGA, SVGA, XGA, SXGA, WXGA, UXGA, WUXGA Other special formats through specified BIOS and factory adjustment.
Graphics auto mode detect	VGA, SVGA, XGA, SXGA, WXGA, UXGA & WUXGA interlaced and non-interlaced
Standard input at source (analog RGB)	VGA analog (15 pin) standard with automatic detection of: Digital Separate Sync; Composite Sync Sync On Green.
Video formats	PAL, NTSC & SECAM
Video inputs	VGA 1 DVI-I (DVI-D + VGA 2) HD Component video Composite video 1 Composite video 2 S-Video S-Video 2 HD-SDI 1 (via HD-1000/2000) HD-SDI 2 (via HD-2000)
Functions display	On screen display (OSD) of functions
OSD menu functions	Image controls: Panel brightness/contrast, Saturation, Hue, Color temperature, Sharpness, Video Scaling, PIP, OSD position, OSD timeout, Image orientation, Auto Source Seek, etc.
OSD menu controls available	Power On/Off Backlight brightness OSD Menu OSD Select up OSD Select down Setting + Setting -
Control interface	Buttons, RS-232, Remote control
Settings memory	Settings are stored in non volatile memory
PC Connectivity	VGA / SVGA / XGA / SXGA / UXGA / WUXGA analog or digital
Controller dimensions	179mm x 120.4mm (7.1" x 4.74")
Power consumption	10w approx. (not including panel power consumption)
Power load maximum	The controller has an overall 3Amp current limit.
Input voltage	12V/24VDC +/- 5%
Power protection	Fuse fitted (Resettable)
DC Power handling	Reverse power polarity protection is equipped on the board
Storage temperature limits	-40°C to +70°C
Operating temperature limits	0°C to +60°C
Use of memory on board	- 2pcs DDR3-1600 1Gbit which is a volatile memory for system processing and frame buffer - 1pc flash 32Mbit which is a non-volatile(NVRAM) memory for system program - 2pcs EEPROM 2Kbit which is a non-volatile(NVRAM) memory for DDC information. - 1pc EEPROM 512Kbit which is a non-volatile(NVRAM) for system and user settings

NOTES

Please note the following:

- For specific panel setup a sample of an LCD may be required (this will be returned) and a copy of the full technical specifications for the panel from the manufacturer.
- Re-layout and custom development services are available.

Specifications subject to change without notice

APPENDIX I – SIGNAL SUPPORT MODE TABLE

VGA PORT :

Mode	Resolution	Clk [MHz]	Horizontal freq [KHz]	Vertical freq [Hz]	Sync Mode
V_60	640x480 60Hz	25.175	31.469	59.940	Digital Separate Sync
V_60	640x480 60Hz	25.175	31.469	59.940	Composite Sync
V_72	640x480 72Hz	31.500	37.861	72.809	Digital Separate Sync
V_72	640x480 72Hz	31.500	37.861	72.809	Sync On Green
V_72	640x480 72Hz	31.500	37.861	72.809	Composite Sync
V_75	640x480 75Hz	31.500	37.500	75.000	Digital Separate Sync
V_75	640x480 75Hz	31.500	37.500	75.000	Sync On Green
V_75	640x480 75Hz	31.500	37.500	75.000	Composite Sync
SV_56	800x600 56Hz	36.000	35.156	56.250	Digital Separate Sync
SV_56	800x600 56Hz	36.000	35.156	56.250	Composite Sync
SV_60	800x600 60Hz	40.000	37.879	60.317	Digital Separate Sync
SV_60	800x600 60Hz	40.000	37.879	60.317	Sync On Green
SV_60	800x600 60Hz	40.000	37.879	60.317	Composite Sync
SV_72	800x600 72Hz	50.000	48.077	72.188	Digital Separate Sync
SV_72	800x600 72Hz	50.000	48.077	72.188	Sync On Green
SV_72	800x600 72Hz	50.000	48.077	72.188	Composite Sync
SV_75	800x600 75Hz	49.500	46.875	75.000	Digital Separate Sync
SV_75	800x600 75Hz	49.500	46.875	75.000	Sync On Green
SV_75	800x600 75Hz	49.500	46.875	75.000	Composite Sync
X_60	1024x768 60Hz	65.000	48.363	60.004	Digital Separate Sync
X_60	1024x768 60Hz	65.000	48.363	60.004	Sync On Green
X_60	1024x768 60Hz	65.000	48.363	60.004	Composite Sync
X_70	1024x768 70Hz	75.000	56.476	70.069	Digital Separate Sync
X_70	1024x768 70Hz	75.000	56.476	70.069	Sync On Green

Specifications subject to change without notice

X_70	1024x768 70Hz	75.000	56.476	70.069	Composite Sync
X_75	1024x768 75Hz	78.750	60.023	75.029	Digital Separate Sync
X_75	1024x768 75Hz	78.750	60.023	75.029	Sync On Green
X_75	1024x768 75Hz	78.750	60.023	75.029	Composite Sync
SX_60	1280x1024 60Hz	108	63.81	60.020	Digital Separate Sync
SX_60	1280x1024 60Hz	108	63.81	60.020	Sync On Green
SX_60	1280x1024 60Hz	108	63.81	60.020	Composite Sync
SX_75	1280x1024 75Hz	135	79.976	75	Digital Separate Sync
SX_75	1280x1024 75Hz	135	79.976	75	Sync On Green
SX_75	1280x1024 75Hz	135	79.976	75	Composite Sync
WUX_60	1920x1080 60Hz	172.8	67.5	60	Digital Separate Sync
WUX_60	1920x1080 60Hz	172.8	67.5	60	Sync On Green
WUX_60	1920x1080 60Hz	172.8	67.5	60	Composite Sync

Remark :

The controller has been designed to take a very wide range of input signals however to optimize the PC's graphics performance we recommend choosing 60Hz vertical refresh rate. To support on higher refresh rate over 60Hz, the LCD panel may not support.

DVI input port :

Mode	Resolution	Clk [MHz]	Horizontal freq [KHz]	Vertical freq [Hz]
V_60	640x480 60Hz	25.175	31.469	59.940
V_67	640x480 67Hz	31.5	37.5	67
V_75	640x480 75Hz	31.5	37.5	75
SV_56	800x600 56Hz	36	35.156	56
SV_60	800x600 60Hz	40.000	37.879	60.317
SV_72	800x600 72Hz	50	48.077	72
SV_75	800x600 75Hz	49.5	46.875	75
X_60	1024x768 60Hz	65.000	48.363	60.004
X_70	1024x768 70Hz	75	56.476	70
X_75	1024x768 75Hz	78.75	60.023	75
SX_60	1280x1024 60Hz	108	63.81	60.020
SX_75	1280x1024 75Hz	135	79.976	75
UX_60	1600x1200 60Hz	162	75.000	60
WUX_60	1920x1080 60Hz	172.8	67.5	60
1080p60	1920x1080p 60Hz	135	67.5	60
1080p59	1920x1080 59Hz	148.35	67.433	60
1080p50	1920x1080 50Hz	149	62.75	50
720p60	1280x720P 60Hz	74.25	45	60
576p50	720x576P 50Hz	26.9568	31.2	50
480p60	720x480P 60Hz	26.9568	31.4	60

HD-COMPONENT PORT :

Mode
720p60
720p59.94
720p50
720p30
720p29.97
1080p30
1080p29.97
1080p25
1080p24
1080p23.98
1080i60
1080i59.94
1080i50
1080p60
1080p59.94
1080p50

COMPOSITE, S-VIDEO INPUT PORT :

System	Resolution	Horizontal freq [KHz]	Vertical freq [Hz]
NTSC	720x480i	15.7	60
NTSC 4.43	720x480i	15.7	60
PAL	720x576i	15.6	50
PAL M	720x576i	15.6	50
SECAM	720x576i	15.6	50

Specifications subject to change without notice

Appendix II – RS-232 control protocols

RS-232 Serial control (Baud rate 2400/4800/9600/14400/19200/38400/57600/115200, 8 bits, 1 stop bit and no parity)

Please refer to Appendix VIII for the procedure how to select different baud rate to be used.

Physical connection :

Controller side
Connector interface : CN8
Mating connector : JST XHP-6

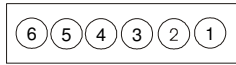

Mating face of CN8

Computer side
Connector interface : Serial port
Mating connector : DB9 Female

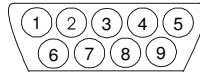

Mating face of RS-232 DB9 Male

PIN#	Description
4	RS-232 Tx Data
5	Ground
6	RS-232 Rx Data

PIN#	Description
2	RS-232 Rx Data
3	RS-232 Tx Data
5	Ground

Remark :

(1) : RS-232 connection cable, 600mm P/N 4260902-00 can be ordered separately for connection.

Software connection :

The OSD function can be controlled through sending the RS-232 protocol.

The RS-232 program can be custom-made to fit for application or it can be used the serial control program, like Accessport, Telix or Serial Utility program developed by DigitalView. Please contact your local support for information.

1. Commands to implement switch mount control buttons

Function	Command	Description	Remark
Menu button	0xf7	Menu button pressed	Button equivalent
Select-down button	0xfa	Select-down button pressed	Button equivalent
Select-up button	0xfb	Select-up button pressed	Button equivalent
Right/+ button	0xfc	Right/+ button pressed	Button equivalent
Left/- button	0xfd	Left/- button pressed	Button equivalent

2. Parameter setting - immediate, relative, reset and query

Function	Command	Description	Acknowledge (if enabled)
Brightness control	0x81, nn "+" "-" "r" "R" "?" "m" "n" "i", ss, nn "o", ss,	Set brightness = value/increment/decrement Reset Query Current Source Maximum query *1 Minimum query *1 Set, Source, value *1 Query, Source *1	Brightness. Range : "4" "E"-"B" "2" Default : "8" "0" ss - reference by Input main select(0x98)
Contrast control - all channels	0x82, "a" "A", nn "+" "-" "r" "R" "?" "m" "n" "i", ss, nn "o", ss,	Set all contrast = value/increment/decrement Reset Query Maximum query *1 Minimum query *1 Set, Source, value *1 Query, Source *1	Contrast Range : "1" "C"-"E" "4" Default : "8" "0" ss - reference by Input main select(0x98)
Saturation control	0x83, nn "+" "-" "r" "R" "?" "m" "n" "i", ss, nn "o", ss,	Set color = value/increment/decrement Reset Query Maximum query *1 Minimum query *1 Set, Source, value *1 Query, Source *1	PAL/NTSC color (In video mode only) Range : "0" "1"-"F" "F" Default : "8" "0" ss - reference by Input main select(0x98)
Hue control	0x84, nn "+" "-" "r" "R" "?" "m" "n" "i", ss, nn "o", ss,	Set tint = value/increment/decrement Reset Query Maximum query *1 Minimum query *1 Set, Source, value *1 Query, Source *1	NTSC tint (In NTSC mode only) Range : "0" "1"-"F" "F" Default : "8" "0" ss - reference by Input main select(0x98)
Phase (tuning) control	0x85, nn "+" "-" "?"	Set dot clock phase = value/increment/decrement Query	Dot clock phase. (In PC mode only)
Image H position	0x86, nnnn "+" "-" "?"	Set img_hpos = value/increment/decrement Query	Image horizontal position. (In PC mode only)
Image V position	0x87, nnnn "+" "-" "?"	Set img_vpos = value/increment/decrement Query	Image vertical position. (In PC mode only)
Sharpness	0x8a, nn "+" "-" "r" "R" "?"	Set sharpness = value/increment/decrement Reset Query	Sharpness. (Video Mode Source only) Default : "0" "C"
Frequency	0x8b,	Set frequency =	Graphic mode H active size (in

Specifications subject to change without notice

	nnnn "+" "-" "?"	Value/increment/decrement Query	pixels)
Scaling Mode	0x8c, "0" "1" "2" "3" "9" "A" "B" "C" "D" "r" "R" "?"	Set graphic image scaling mode = value Reset Query	Image expansion on/off. "0" – 1:1 "1" – fill screen "2" – fill to aspect ratio "9" – 4:3 "A" – 16:9 "B" – 16:10 "C" – 2.35:1 "D" – 2:1
Set display orientation (Effective on V1.26.00.00 or later firmware revision)	0x8e, n "r" "R" "?"	Set display orientation = value/increment/decrement Reset Query	"0" – Normal. "1" – Vertical Flip. "2" – Horizontal Flip. "3" – Rotate. "N" – Not support.
OSD H position	0x90, nnn "+" "-" "r" "R" "?"	Set osd_hpos = value/increment/decrement Reset Query	OSD horizontal position.
OSD V position	0x91, nnn "+" "-" "r" "R" "?"	Set osd_vpos = value/increment/decrement Reset Query	OSD vertical position.
OSD menu timeout	0x93, nn "+" "-" "r" "R" "?"	Select menu timeout = value/increment/decrement Reset Query	OSD menu timeout value. "0""0" – Continuous. value – Round up to nearest available step. if value > max available step, set it to the max available step.
Select OSD language	0x95, n "r" "R" "?"	Select language = English, Chinese,... Reset Query	"0" – English. "2" - French "3" – Spanish "6" - German "8" – Chinese
Input main select	0x98, nn "+" "-" "r" "R" "?"	Select input main = PC or VIDEO or next available Reset Query	Main selected. "0x41,0x31" VGA 1 "0x41,0x32" VGA 2 "0x42,0x31" Composite 1 "0x42,0x32" Composite 2 "0x43,0x31" S-video 1 "0x43,0x32" S-video 2 "0x44,0x31" HD/SD Component "0x45,0x31" HDSDI 1 ⁺⁺ "0x45,0x32" HDSDI 2 ⁺⁺ "0x46,0x31" DVI
Auto Source Seek	0x99, nn , "0" "1" "?" "o"	Set Auto source enable = *1 Source Disable/ Enable Query Valid Source query	"nn" = "0x41,0x31" VGA 1 "0x41,0x32" VGA 2 "0x42,0x31" Composite 1 "0x42,0x32" Composite 2 "0x43,0x31" S-video 1 "0x43,0x32" S-video 2 "0x44,0x31" HD/SD Component "0x45,0x31" HDSDI 1 ⁺⁺ "0x45,0x32" HDSDI 2 ⁺⁺ "0x46,0x31" DVI
Source Layout	0x9a, n "r" "R" "?"	Select source layout = Single, PIP, PBP, PBPT Reset, Query	Query: "0"- Single "1"- Picture in Picture (PIP) "2"- Picture by Picture (PBP)

Specifications subject to change without notice

			"3"- Picture by Picture Tall (PBPT) "F" – Turn ON PIP Window ***
Gamma value select (Effective on V1.27.00.00 or later firmware revision)	0x9d, n "r" "R" "?"	Select GAMMA value = Value Reset Query	GAMMA value: "5" – 1.8, "6" – 1.9, "7" – 2.0, "8" – 2.1, "2" – 2.2, "9" – 2.3, "A" – 2.4, "B" – 2.5, "C" – 2.6
Auto power off	0x9f, "0" "1" "r" "R" "?"	Set power down option = On/Off Reset Query	"0" – Off. "1" – On.
Hotkey 1	0xa0, "1", n "r" "R" "?"	Set Hotkey 1= Value Reset Query	"2" – brightness.(Default) "3" – contrast. "4" – colour. "5" – input source. "7" – zoom "8" – freeze "9" - PIP "B" – No function "D" - PIP Swap "E" – Aspect Ratio "G" – Hue "H" – Backlight "I" – Auto Picture Setup "K" - PIP ON/OFF
Hotkey 2	0xa0, "2", n "r" "R" "?"	Set Hotkey 2 = value Reset Query	"2" – brightness. "3" – contrast. (Default) "4" – colour. "5" – input source. "7" – zoom "8" – freeze "9" - PIP "B" – No function "D" - PIP Swap "E" – Aspect Ratio "G" – Hue "H" – Backlight "I" – Auto Picture Setup "K" - PIP ON/OFF
Runtime counter	0xa1, nnnn "r" "R" "?"	runtime counter value = nnnn (* 0.5 hour) Reset Query	Runtime = nnnn.
PIP H position	0xa4, nnn "+" "-" "r" "R" "?"	Set PIP_hpos = value/increment/decrement Reset Query	PIP window horizontal position. "0"0"0" ~"0"6"4" Default : "0"5"5"
PIP V position	0xa5, nnn "+" "-" "r" "R" "?"	Set PIP_vpos = value/increment/decrement Reset Query	PIP window vertical position. "0"0"0" ~"0"6"4" Default : "0"1"4"
PIP window size select	0xa6, nn "r" "R" "?"	Select PIP window size = PIP window size value Reset Query	Main selected. PIP off if "nn" = "0"0" "0"0" ~ "1"2" "1"9" : Size by Size

			"1" A : Size by Size Tall Default : "0"0"
PIP source select	0xa7, n "r" "R" "?"	Select input main = Video source value Reset Query	Main selected. "0x41,0x31" VGA 1 "0x41,0x32" VGA 2 "0x42,0x31" Composite 1 "0x42,0x32" Composite 2 "0x43,0x31" S-video 1 "0x43,0x32" S-video 2 "0x44,0x31" HD/SD Component "0x45,0x31" HDSDI 1++ "0x45,0x32" HDSDI 2++ "0x46,0x31" DVI
Zoom level	0xa8, nnnn "+" "-" "r" "R" "?"	Set Zoom level = value/increment/decrement Reset Query	Zoom level.
Zoom H position	0xa9, nnnn "+" "-" "r" "R" "?"	Set Zoom_hpos = value/increment/decrement Reset Query	Zoom window horizontal position. Default : 0x30 0x30 0x30 0x30 The min and max values will change depends on input resolution.
Zoom V position	0xaa, nnnn "+" "-" "r" "R" "?"	Set Zoom_vpos = value/increment/decrement Reset Query	Zoom window vertical position. Default : 0x30 0x30 0x30 0x30 The min and max values will change depends on input resolution.
Colour temperature select	0xb3, n "r" "R" "?"	Select colour temperature = value Reset Query	Main selected. "0" – 9300K. "1" – 8000K.(Default) "2" – 6500K. "3" – 5000K "4" - User
Red level for selected colour temperature	0xb4, nn "+" "-" "r" "R" "?" "m" "n" "i", ss, c, nn "o", ss, c	Set the level of the red channel for the selected colour temp. = value/increment/decrement Reset Query Maximum query *1 Minimum query *1 Set, Source, Temperature Group, value *1 Query, Source *1	Red level for selected colour temperature. Range : "9" C - "F" F Default : "E" 3 for 8000K c – reference by Color Temperature ss - reference by Input main select(0x98)
Green level for selected colour temperature	0xb5, nn "+" "-" "r" "R" "?" "m" "n" "i", ss, c, nn "o", ss, c	Set the level of the green channel for the selected colour temp. = value/increment/decrement Reset Query Maximum query *1 Minimum query *1 Set, Source, Temperature Group, value *1 Query, Source *1	Green level for selected colour temperature Range : "9" C - "F" F Default : "E" 3 for 8000K c – reference by Color Temperature ss - reference by Input main select(0x98).
Blue level for selected colour temperature	0xb6, nn "+" "-" "r" "R" "?"	Set the level of the blue channel for the selected colour temp. = value/increment/decrement Reset Query	Blue level for selected colour temperature. Range : "9" C - "F" F Default : "E" 3 for 8000K

Specifications subject to change without notice

	“m” “n” “i”, ss, c, nn “o”, ss, c	Maximum query *1 Minimum query *1 Set, Source, Temperature Group, value *1 Query, Source *1	c – reference by Color Temperature ss - reference by Input main select(0x98).
Graphic horizontal resolution enquiry	0xb7	Horizontal resolution (in pixels) in 3 digit hex number	“nnn” = horizontal resolution
Graphic vertical resolution enquiry	0xb8	Vertical resolution (in lines) in 3 digit hex number	“nnn” = vertical resolution
Graphic horizontal sync frequency enquiry	0xb9	Horizontal sync frequency (in units of 100Hz) in 3 digit hex number	“nnn” = horizontal frequency
Graphic vertical sync frequency enquiry	0xba	Vertical sync frequency (in units of Hz) in 3 digit hex number and 1 char	“nnnn” = vertical frequency nnn = 3 digit hex c= “i” or “p” interlace or Progressive 0xba added the interlace(i) or Progressive(p) feedback.
OSD status enquiry	0xbb	Status of OSD	“0” – OSD turned off “1” – OSD turned on
Display Video Source Select	0xbc, “?” “0” “1”	Display Video source select Query Name of video source not displayed. After switching to a new video source, the name of the video source is displayed for 5 seconds.	“0” – Disabled. “1” – Enabled.
OSD turn off	0xbd	Turn off the OSD.	“0” – fail. “1” – successful.
Query External Memory	0xcb, “2”	Check External Memory 24c256	“0” – Not Installed “1” – Installed “?” – Not Support
Query Revision Number	0xcb, “3”	Read Revision Number	“nn” = Revision number
Backlight control	0xe0, nn “+” “-” “=” “R” “r” “?”	Set Backlight = value/increment/decrement Display OSD indicator Reset Query	Backlight. Range: D/A : “0””0” ~ “5””2” 100Hz : “0””0” ~ “8””3” 120Hz : “0””0” ~ “6””D” 140Hz : “0””0” ~ “5””D” 160Hz : “0””0” ~ “5””2” 180Hz : “0””0” ~ “4””8” 200Hz : “0””0” ~ “4””2” 220Hz : “0””0” ~ “3””B” 240Hz : “0””0” ~ “3””6” 260Hz : “0””0” ~ “3””2” 280Hz : “0””0” ~ “2””E” 300Hz : “0””0” ~ “2””B” 320Hz : “0””0” ~ “2””8” 340Hz : “0””0” ~ “2””6” 360Hz : “0””0” ~ “2””4” 380Hz : “0””0” ~ “2””2” 400Hz : “0””0” ~ “2””0” 420Hz : “0””0” ~ “1””E” 440Hz : “0””0” ~ “1””D”
Backlight On/Off	0xe1, “0” “1” “R” “r”	Backlight Off / Backlight On /Status	“0” – Backlight Off “1” – Backlight On.(Default) “?” – Backlight On/Off Query

Specifications subject to change without notice

	"?"		
Color Monochrome mode selection (Output Channel Select) (Effective on V1.26.00.00 or later firmware revision)	0xe2 "0" "1" "2" "3" "4" "5" "6" "R" "r" "?"	Off/ Blue Only/ Red Only/ Green Only/ Blue Mono/ Red Mono/ Green Mono/	"0" – Off "1" – Blue Only "2" – Red Only "3" – Green Only "4" – Blue Mono "5" – Red Mono "6" – Green Mono
Backlight D/A / PWM	0xe5 "0" "1" "R" "r" "?"	Set : PWM or D/A Reset Query	"0" – PWM "1" – D/A (Default)
Backlight PWM Frequency	0xe6, nnn "+" "-" "R" "r" "?"	Set Backlight PWM Frequency = value/increment/decrement Reset Query	+/- 20Hz Value 100Hz : "0", "6", "4" 120Hz : "0", "7", "8" 140Hz : "0", "8", "C" 160Hz : "0", "A", "0" (Default) 180Hz : "0", "B", "4" 200Hz : "0", "C", "8" 220Hz : "0", "D", "C" 240Hz : "0", "F", "0" 260Hz : "1", "0", "4" 280Hz : "1", "1", "8" 300Hz : "1", "2", "C" 320Hz : "1", "4", "0" 340Hz : "1", "5", "4" 360Hz : "1", "6", "8" 380Hz : "1", "7", "C" 400Hz : "1", "9", "0" 420Hz : "1", "A", "4" 440Hz : "1", "B", "8"
Backlight Invert	0xe7 "0" "1" "R" "r" "?"	Set On or Off Reset Query	"0" – Off "1" – On
Red Offset for selected colour temperature	0xe8, nn "+" "-" "r" "R" "?" "m" "n" "i", ss, c, nn "o", ss, c	Set the Offset of the red channel for the selected colour temp. = value/increment/decrement Reset Query Maximum query *1 Minimum query *1 Set, Source, Temperature Group, value *1 Query, Source *1	Red Offset for selected colour temperature. Range : "8""0"- "7""F" Default : "0""0" c – reference by Color Temperature ss - reference by Input main select(0x98)
Green Offset for selected colour temperature	0xe9, nn "+" "-" "r" "R" "?" "m" "n" "i", ss, c, nn "o", ss, c	Set the Offset of the green channel for the selected colour temp. = value/increment/decrement Reset Query Maximum query *1 Minimum query *1 Set, Source, Temperature Group, value *1 Query, Source *1	Green Offset for selected colour temperature. Range : "8""0"- "7""F" Default : "0""0" c – reference by Color Temperature ss - reference by Input main select(0x98)
Blue Offset for selected colour temperature	0xea, nn "+" "-"	Set the Offset of the blue channel for the selected colour temp. =	Blue Offset for selected colour temperature.

Specifications subject to change without notice

	"r" "R" "?" "m" "n" "i", ss, c, nn "o", ss, c	value/increment/decrement Reset Query Maximum query *1 Minimum query *1 Set, Source, Temperature Group, value *1 Query, Source *1	Range : "8"0"-7"0" Default : "0"0" c – reference by Color Temperature ss - reference by Input main select(0x98)
PIP Window Blend Level	0xed, nn "+" "-" "R" "r" "?"	Select PIP Transparency Level PIP Transparency value Reset Query	PIP Transparency "0"0" = 6.25% "0"1" = 12.5% "0"2" = 18.75% "0"3" = 25% "0"4" = 31.25% "0"5" = 37.5% "0"6" = 43.75% "0"7" = 50% "0"8" = 56.25% "0"9" = 62.5% "0"10" = 68.75% "0"11" = 75% "0"12" = 81.25% "0"13" = 87.5% "0"14" = 93.75% "0"15" = 100%.
Light Detector	"0xee", "0x4A" "0" "1" "R" "r" "?" "S" "s"	Light Detector Off / Light Detector On Light Detector On/Off Query Light Detector Value Query	"0" –Light Detector Off (Default) "1" –Light Detector On. "?" – Light Detector On/Off Query "S" "s" –Light Detector Value Query 0x00~0xFF
Access Programming Mode	"0xee", "0x59" "0" "1" "2" "?"	Cancel Access / Set Access Run Smart ISP programming Query	"0" - Cancel Access "1" - Set next start up to access the programming mode.
Minimum Backlight Value	0xee, "0x5C" nn "+" "-" "R" "r" "?"	Set Minimum Backlight value = value / increment / decrement Reset Query	Minimum Backlight value/ Range : D/A : "0"0" ~ "3"2" 100Hz : "0"0" ~ "3"2" 120Hz : "0"0" ~ "3"2" 140Hz : "0"0" ~ "3"2" 160Hz : "0"0" ~ "3"2" 180Hz : "0"0" ~ "3"2" 200Hz : "0"0" ~ "3"2" 220Hz : "0"0" ~ "3"2" 240Hz : "0"0" ~ "3"2" 260Hz : "0"0" ~ "3"2" 280Hz : "0"0" ~ "3"2" 300Hz : "0"0" ~ "3"2" 320Hz : "0"0" ~ "3"2" 340Hz : "0"0" ~ "3"0" 360Hz : "0"0" ~ "3"0" 380Hz : "0"0" ~ "3"0" 400Hz : "0"0" ~ "3"1" 420Hz : "0"0" ~ "3"1" 440Hz : "0"0" ~ "3"1"
OSD Switch Mount Lock	"0xee", "0x62" "0" "1" "?"	Unlock / Lock Query	"0" - Unlock "1" - Lock
Anti image retention	"0xee", "0x6C" "E", "1" "0"	Anti image retention On / Off	
Anti image retention Method	"0xee", "0x6C" "M", "0" "1" "2" "3"	Run Anti image retention Method Horizontal Pan Vertical Pan Flash Pixel Shift	
Anti image	"0xee", "0x6C"		

Specifications subject to change without notice

retention Pixel Shift Manual	“P” , “H” “V” “nn” “+” “-” “R” “r” “?”	Anti image retention Pixel Shift Manual Horizontal / Vertical Shift value/increment/decrement Reset Query	
------------------------------	--	--	--

Remark :

++ - Support when HD-1000/-2000/-3000S connected.

3. Other control

Function	Command	Description	Acknowledge (if enabled)
Select RS-232 acknowledge	0xc1, “0” “1”	Disable/enable command acknowledge.	“0” – acknowledge disabled. “1” – acknowledge enabled.
Auto-setup	0xc3	Start auto-setup of current vmode.	“0” – fail. “1” – successful.
Command availability	0xc4, n	Check whether a command is available.	“0” – not available. “1” – available.
Auto-calibration	0xc5	Start auto-calibration of gain of the RGB amplifier.	“0” – fail. “1” – successful.
Freeze frame	0xc6, “0” “1” “=”	Unfreeze / freeze frame Display OSD indicator	“0” – unfreeze. “1” – freeze.
Soft Power On/Off	0xc8, “0” “1” “?”	Soft power off/on query	“0” - Soft power off “1” - Soft power on
Query video input status	0xc9	Query the status of the primary & pip status	“nn,nn” = input status “nn,xx” digit = primary status: “0”, “0” : invalid “A”, “1” VGA 1 “A”, “2” VGA 2 “B”, “1” Composite 1 “B”, “2” Composite 2 “C”, “1” S-video 1 “C”, “2” S-video 2 “D”, “1” Component 1 (via CNV2) “E”, “1” HDSDI 1 ⁺⁺ “E”, “2” HDSDI 2 ⁺⁺ “F”, “1” DVI “xx,nn”= PIP input status: “0”, “0” : invalid “A”, “1” VGA 1 “A”, “2” VGA 2 “B”, “1” Composite 1 “B”, “2” Composite 2 “C”, “1” S-video 1 “C”, “2” S-video 2 “D”, “1” Component 1 (via CNV2) “E”, “1” HDSDI 1 ⁺⁺ “E”, “2” HDSDI 2 ⁺⁺ “F”, “1” DVI
Query BIOS version	0xcb, “0”	Read BIOS version	BIOS version “VV.YY.ZZ” VV = V0 or E0, V0 = Release version E0 = Engineering Sample YY= Version Number

Specifications subject to change without notice

			ZZ= Customer Number
Query PCBA number	0xcb, "1"	Read PCBA number	"nnnnn" = PCBA number SVH-1920v2= "41752"
Reset to Factory Defaults	0xce	Reset all parameters to default value	"1" – successful.
Reset to Factory Defaults with (color temp)	0xcf	Reset all parameters for all video modes to default value	"1" - successful.
Saved Calibrated default	0xd7	Saving all parameters to user default value	"1" - successful.
Load Calibrated default	0xd8	Loading all parameters to user default value	"1" - successful. "0" - not successful "E" – Checksum Error
Wide Screen Mode Selection	0xd9, "n""n" "r" "R" "?"	Wide Screen Mode Reset Query	"n,n" = input status "n,x" digit = Group 1 mode select: "0" – 1024x768 (Default) "1" – 1280x768 "2" – 1366x768 "3" - 1360x768 "x,n" = :Group 2 mode select "4" - 1440x900 (Default) "5" - 1600x900

The following commands for sending texts by using RS-232 command.

Function	Command	Description	Acknowledge (if enabled)
Send Line	0xF0, "S" "LL" "TEXT" "0x0A" Return "1"	"S" = "0x53 or 0x73" Send command ----- - "LL" = "0x30,0x31~0x30,0x34" Line number (Rang 0~4 lines) ----- - "Text"= ASCII code, "0x20~0x7E" Character(Rang 0~34) ----- - 0x0A = End of line	"S" – Send Command "LL" – Line Number "Text" – Character "0x0A" – End of Line "1" - successful.
e.g Display "Send Text" message on screen: RS232 Code:"0xF0 0x53 0x30 0x31 0x53 0x65 0x6E 0x64 0x20 0x54 0x65 0x78 0x74 0x0A" Return Code: "0xF0 0x53 0x30 0x31 0x53 0x65 0x6E 0x64 0x20 0x54 0x65 0x78 0x74 0x0A 0x31"			
Clear Line	0xF0, "C" "LL" Return "nn"	"C" = "0x43 or 0x63" Clear command ----- - "LL" = "0x30,0x31~0x30,0x34" Line number (Rang 0~4 lines)	"C" – Clear command "LL" – Line Number "nn" – Return Line number
e.g Clear Line 1 RS232 Code: "0xF0 0x43 0x30 0x31" Return Code: "0xF0 0x43 0x30 0x31 0x30 0x31"			

Text Window Horizontal Position	0xF0, "H" "ss" Return "nn"	"H" = "0x48 or 0x68" ----- --"nn" = "0x30,0x30~0x46,0x46"	"H" – Horizontal Position command "ss" – Set Horizontal Position number "nn" – Return Position number
e.g Set Text Window Horizontal Position RS232 Code: "0xF0 0x48 0x30 0x31" Return Code: "0xF0 0x48 0x30 0x31 0x30 0x31"			
Text Window Vertical Position	0xF0, "V" "ss" Return "nn"	"V" = "0x56 or 0x76" ----- --"nn" = "0x30,0x30~0x46,0x46"	"V" – Vertical Position command "ss" – Set Vertical Position number "nn" – Return Position number
e.g Set Text Window Vertical Position RS232 Code: "0xF0 0x56 0x30 0x31" Return Code: "0xF0 0x56 0x30 0x31 0x30 0x31"			

Left offset	0xF0, "O" "SSS" Return "nnn"	"O" = "0x4F or 0x6F" Set Left Offset command ----- - "SSS" = "0x30,0x30,0x30~ 0x33,0x46,0x46" Offset Value (Rang 000~3ff)	"O" – Left Offset Command "SSS"- Offset Value (pixels) "nnn"- Return Value(pixels)
e.g Set Left Offset = 100 pixels (0x64 (HEX)) RS232 Code: "0xF0 0x4F 0x30 0x36 0x34" Return Code: "0xF0 0x4F 0x30 0x36 0x34 0x30 0x36 0x34"			
Text Window Horizontal Size	0xF0, "X" "SSS" Return "nnn"	"X" = "0x58" Set Horizontal Size command ----- - "SSS" = "0x31,0x45,0x30~ 0x37,0x38,0x30" Horizontal Size Value (Rang 000~3ff)	"X" –Horizontal Size "SSS"- Size Value (pixels) "nnn"- Return Value(pixels)
e.g Set Text Window Horizontal Size = 640 pixels (0x280 (HEX)) RS232 Code: "0xF0 0x58 0x32 0x38 0x30" Return Code: "0xF0 0x58 0x32 0x38 0x30 0x32 0x38 0x30"			
Background Transparency	0xF0, "B" "N" Return "n"	"B" = "0x42 or 0x62" Set Transparency command ----- "N" = "0x30~0x46" Transparency Value (Rang 00~0F)	"B" - Transparency command "N" – Transparency Value "n"- Return Value 0x00 =opaque
Set background Transparency value is 8 RS232 Code: "0xF0 0x42 0x38" Return Code: "0xF0 0x42 0x38 0x38"			
Text Overlay Background On or Off	0xF0, "Q" "N" Return "n"	"Q" = "0x51 or 0x71" Set Background Enable or Disable ----- "N" = "0x30~0x31"	"B" - command "1" Turn On Text Overlay Background "0" Turn Off Text Overlay

Specifications subject to change without notice

			Background "n"- Return Value
Set background Transparency value is 8 RS232 Code: "0xF0 0x51 0x31" Return Code: "0xF0 0x51 0x31 0x31"			

Please set the "Background Transparency" and "Left offset" commands before the "Send Line" command.

The RS-232 command strings sent in one time can support up to 380 bytes via CN8 port
 The RS-232 command string sent in one time can support up to 50 bytes via CN1 or J1 port.

n = 1-byte ascii-coded hex number, e.g., parameter value of 0x1 is represented by “1” (0x31).
 mn or nn = 2-byte ascii-coded hex number, e.g., parameter value of 0x1e is represented by “1”, “e” | “E”
 (0x31, 0x6e|0x4e).

Please refer to the ASCII to Hex convert table below.

Hex to ASCII conversion table

Hex	ASCII	Hex	ASCII	Hex	ASCII	Hex	ASCII
0x30	0	0x41	A	0x61	a	0x2B	+
0x31	1	0x42	B	0x62	b	0x2D	-
0x32	2	0x43	C	0x63	c	0x3F	?
0x33	3	0x44	D	0x64	d		
0x34	4	0x45	E	0x65	e		
0x35	5	0x46	F	0x66	f		
0x36	6	0x47	G	0x67	g		
0x37	7	0x48	H	0x68	h		
0x38	8	0x49	I	0x69	i		
0x39	9	0x4A	J	0x6A	j		
		0x4B	K	0x6B	k		
		0x4C	L	0x6C	l		
		0x4D	M	0x6D	m		
		0x4E	N	0x6E	n		
		0x4F	O	0x6F	o		
		0x50	P	0x70	p		
		0x51	Q	0x71	q		
		0x52	R	0x72	r		
		0x53	S	0x73	s		
		0x54	T	0x74	t		
		0x55	U	0x75	u		
		0x56	V	0x76	v		
		0x57	W	0x77	w		
		0x58	X	0x78	x		
		0x59	Y	0x79	y		
		0x5A	Z	0x7A	z		

Appendix III – Mapping definition

- Definition of Mapping A :

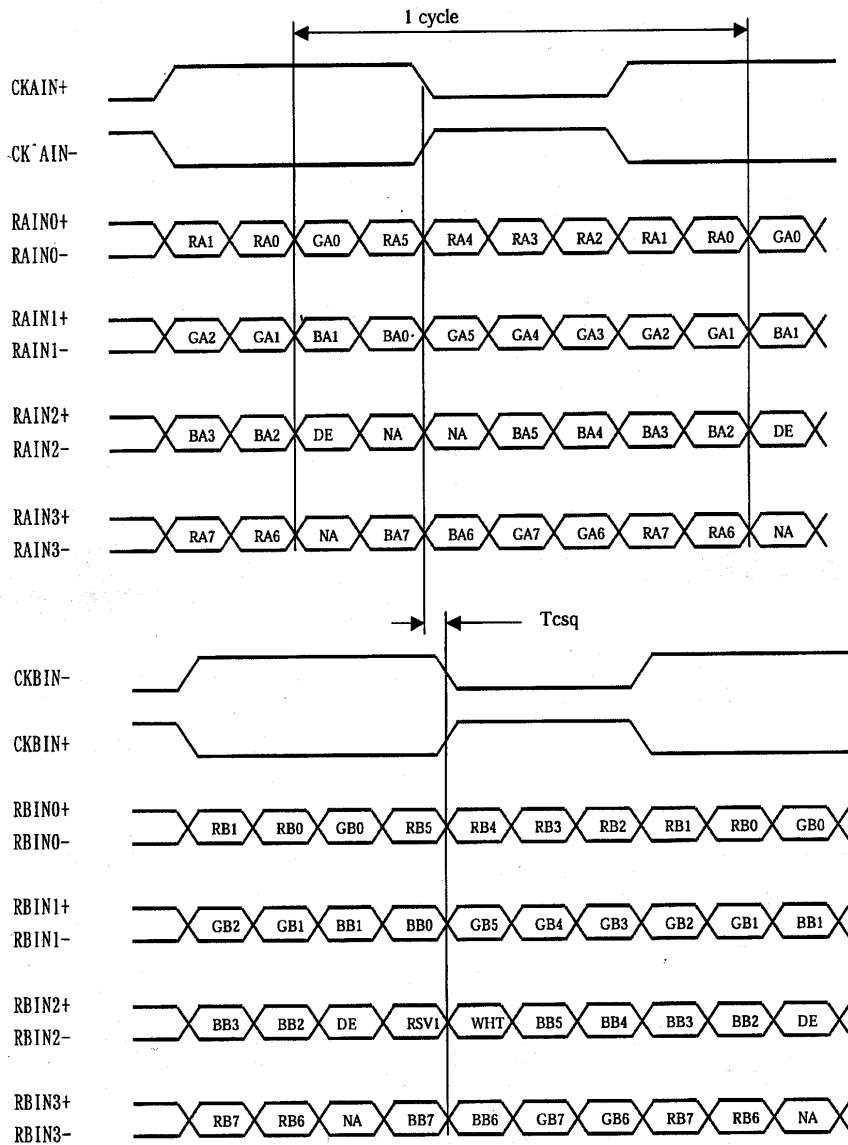

- Definition of Mapping B :

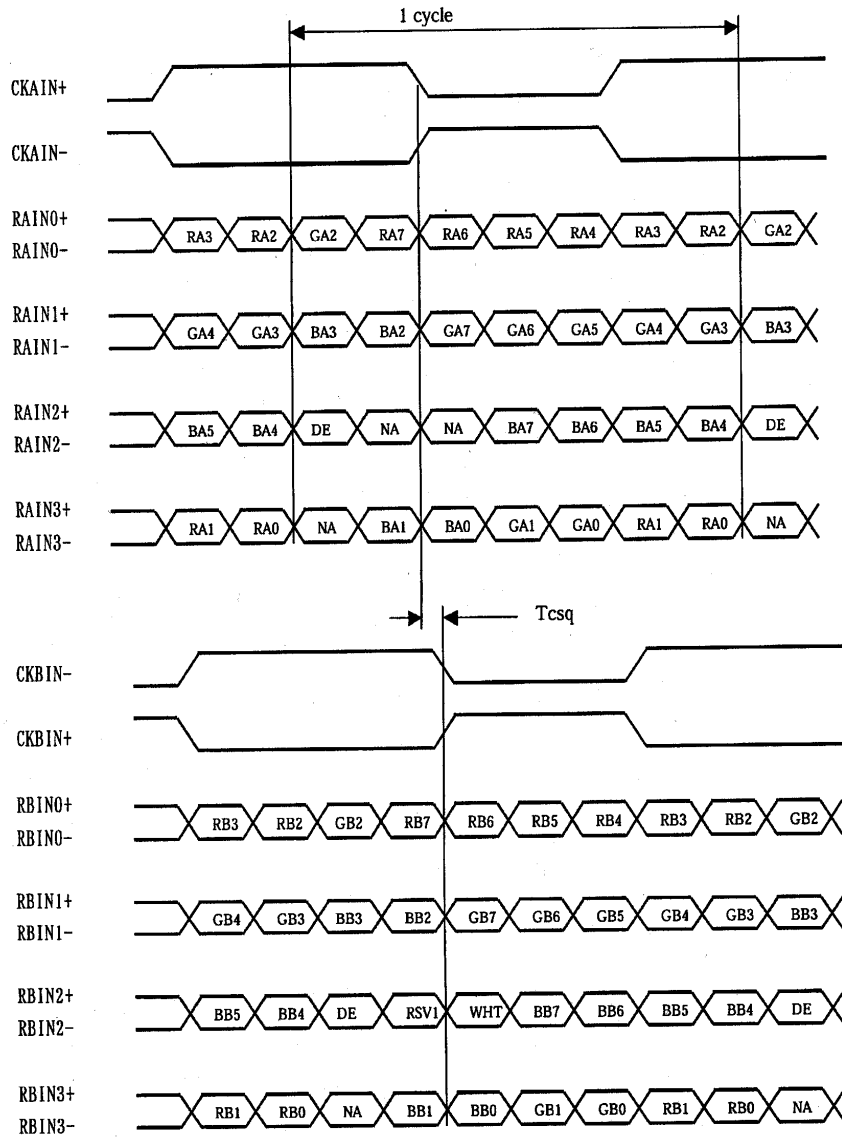

- Definition of VESA :

DPort Output Pair	Bit 6	Bit 5	Bit 4	Bit 3	Bit 2	Bit 1	Bit 0
DB[7:6] / TXDEC							
DB[3:2] / TXDE0	GE0	RE5	RE4	RE3	RE2	RE1	RE0
DB[5:4] / TXDE1	BE1	BE0	GE5	GE4	GE3	GE2	GE1
DB[9:8] / TXDE2	EN	VS	HS	BE5	BE4	BE3	BE2
DG[3:2] / TXDE3	field/prg	BE7	BE6	GE7	GE6	RE7	RE6
DG[5:4] / TXDE4	low	BE9	BE8	GE9	GE8	RE9	RE8
DG[7:6] / TXDO0	GO0	RO5	RO4	RO3	RO2	RO1	RO0
DG[9:8] / TXDO1	BO1	BO0	GO5	GO4	GO3	GO2	GO1
DR[5:4] / TXDO2	EN	VS	HS	BO5	BO4	BO3	BO2
DR[7:6] / TXDO3	field/prg	BO7	BO6	GO7	GO6	RO7	RO6
DR[9:8] / TXDO4	low	BO9	BO8	GO9	GO8	RO9	RO8
DR[3:2] / TXDOC							

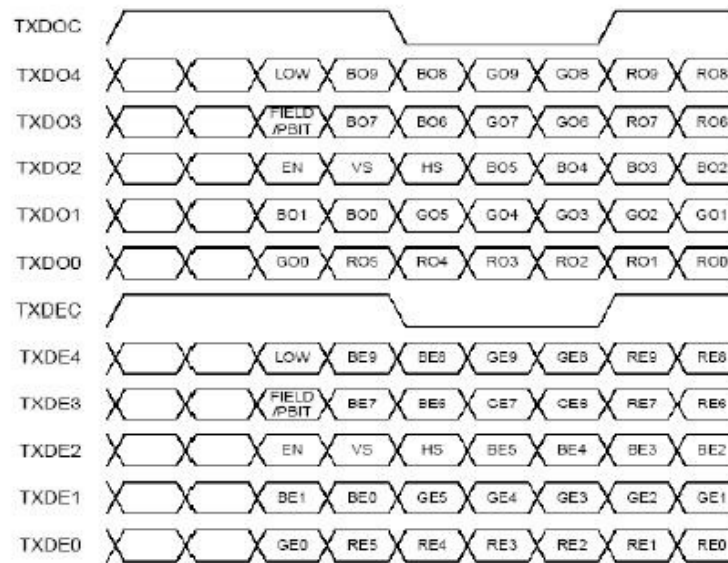

- Definition of JEIDA :

DPort Output Pair	Bit 6	Bit 5	Bit 4	Bit 3	Bit 2	Bit 1	Bit 0
DB[7:6] / TXDEC							
DB[3:2] / TXDE0	GE4	RE9	RE8	RE7	RE6	RE5	RE4
DB[5:4] / TXDE1	BE5	BE4	GE9	GE8	GE7	GE6	GE5
DB[9:8] / TXDE2	EN	VS	HS	BE9	BE8	BE7	BE6
DG[3:2] / TXDE3	field/prg	BE3	BE2	GE3	GE2	RE3	RE2
DG[5:4] / TXDE4	low	BE1	BE0	GE1	GE0	RE1	RE0
DG[7:6] / TXDO0	GO4	RO9	RO8	RO7	RO6	RO5	RO4
DG[9:8] / TXDO1	BO5	BO4	GO9	GO8	GO7	GO6	GO5
DR[5:4] / TXDO2	EN	VS	HS	BO9	BO8	BO7	BO6
DR[7:6] / TXDO3	field/prg	BO3	BO2	GO3	GO2	RO3	RO2
DR[9:8] / TXDO4	low	BO1	BO0	GO1	GO0	RO1	RO0
DR[3:2] / TXDOC							

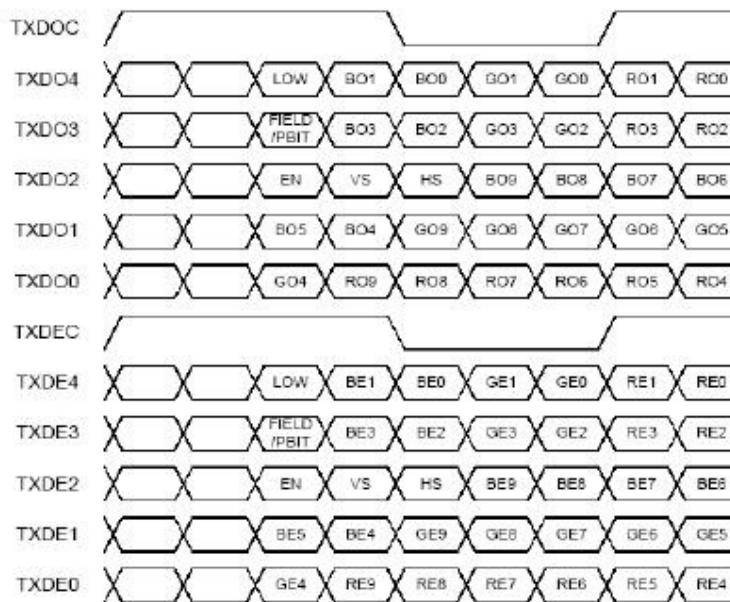

Appendix IV – Auto Color Gain

The Auto Color Gain function is supported in the VGA mode only and is designed to calibrate the controller to the incoming video signal. In order to calibrate correctly, the display must be displaying an image containing both black and white data (see illustration below) when the function is used. The internal processor of the video controller chip will then execute a process to adjust the relative values of the RGB signals to achieve the best performance. The parameters of the corrected RGB values are then stored in the controller and are unaffected by the Reset Factory Defaults function.

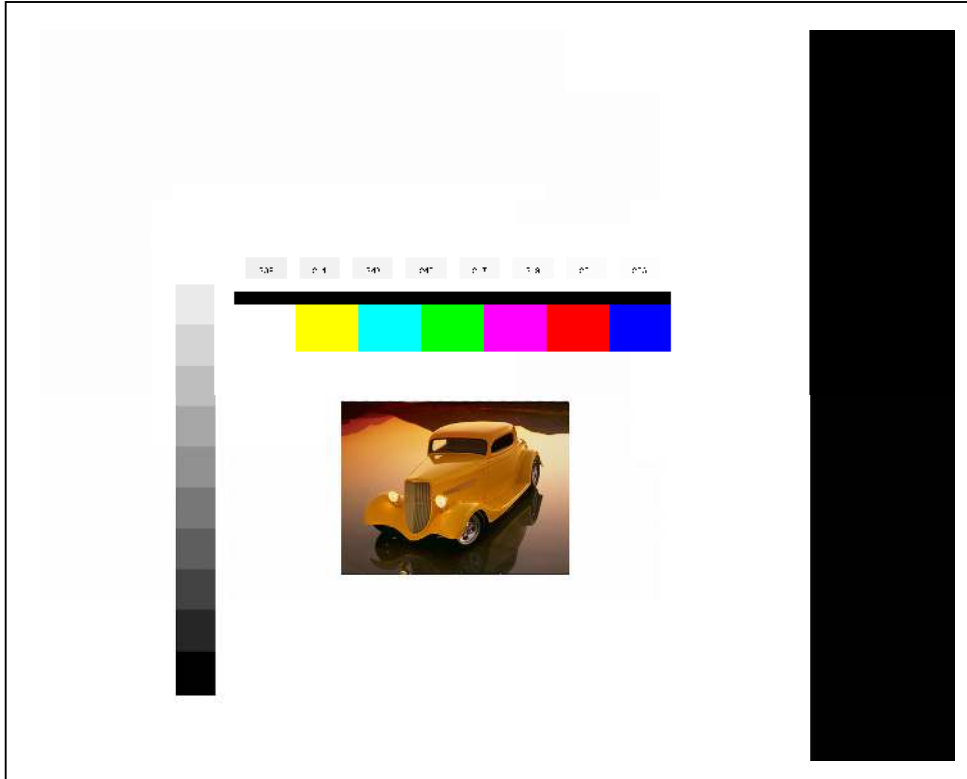

The reference pattern can be downloaded at :

http://www.digitalview.com/support/downloads/TestPattern_1280.BMP

This reference pattern is for 1280x1024 resolution and it needs to set your VGA input source to 1280x1024 resolution before performing the Auto Color Gain function. The position of the black vertical bar in the pattern at the right side is important. It will affect the calibration result if you are setting the VGA input to other resolution.

Warning - If the Auto Color Gain is executed without an appropriate image being displayed, then the process will set incorrect values and the display colors will be distorted. If this occurs, then it can either be corrected by performing the process correctly or if this is not possible then the Reset Color Gain function can be used. This function will reset the stored RGB values to a set of approximate values.

Appendix V – DV remote control unit work for SVH-1920v2

P/N 559000106-3 :
DigitalView remote control unit
(without DV logo silk screen
printing)

P/N 559000105-3 :
DigitalView remote control unit
(with DigitalView logo silk screen
printing)



BUTTON	FUNCTION
POWER BUTTON	Soft power ON/OFF button.
SEL UP (^) / SEL DN (v)	Use this button to direct control the hotkey function. Press the "SEL UP" button to increase the pre-set hotkey parameter value and the "SEL DN" button to decrease the pre-set hotkey parameter value. In OSD menu, pressing this button to select the items.
+ / - BUTTON	Use this button to direct control the hotkey function. Press the "+" button to increase the pre-set hotkey parameter value and the "-" button to decrease the pre-set hotkey parameter value. In OSD menu, pressing this button to adjust the settings.
OSD BACK BUTTON	Use to display the OSD menu and go to the previous OSD screen.
OSD NEXT BUTTON	Use to display the OSD menu and go to the next OSD screen.
DISPLAY BUTTON	Use to view an on-screen information. When OSD menu displayed, press this button to turn it off.
AV/TV BUTTON	Use to select the input source. (VGA/DVI/..)
SOUND (ZOOM) BUTTON	Use to display the zoom menu. Press the "+" to zoom in the picture and the "-" to zoom out the picture.
PLAY (YPbPr) BUTTON	Press this button in the non OSD menu display mode to select Component 1 source.
STOP (VGA) BUTTON	Press this button in the non OSD menu display mode to select VGA source.
DVI BUTTON	Press this button in the non OSD menu display mode to select DVI source.

Appendix VI – PIP mix table

	VGA 1 (P1)	VGA 2 (P2/CN6)	DVI (P2)	Composite 1 (J2/CNV1/CNV5)	Composite 2 (CNV5)	S-Video 1 (J1/CNV1/CNV5)	S-Video 2 (CNV5)	HD Component 1 (CNV2)	HD-SDI 1**	HD-SDI 2##
VGA 1 (P1)	X	X	✓	✓	✓	✓	✓	X	✓	✓
VGA 2 (P2/CN6)	X	X	✓	✓	✓	✓	✓	X	✓	✓
DVI (P2)	✓	✓	X	✓	✓	✓	✓	✓	✓	✓
Composite 1 (J2/CNV2/CNV5)	✓	✓	✓	X	X	X	X	✓	✓	✓
Composite 2 (CNV5)	✓	✓	✓	X	X	X	X	✓	✓	✓
S-Video 1 (J1/CNV1/CNV5)	✓	✓	✓	X	X	X	X	✓	✓	✓
S-Video 2 (CNV5)	✓	✓	✓	X	X	X	X	✓	✓	✓
HD-Component 1 (CNV2)	X	X	✓	X	X	X	X	X	✓	✓
HD-SDI 1**	✓	✓	✓	✓	✓	✓	✓	✓	X	X
HD-SDI 2##	✓	✓	✓	✓	✓	✓	✓	✓	X	X

** - via HD-1000/HD-2000

- via HD-2000

Appendix VII – HD-1000 / HD-2000 connection

SVH-1920v2 & HD-1000 / HD-2000 connection :

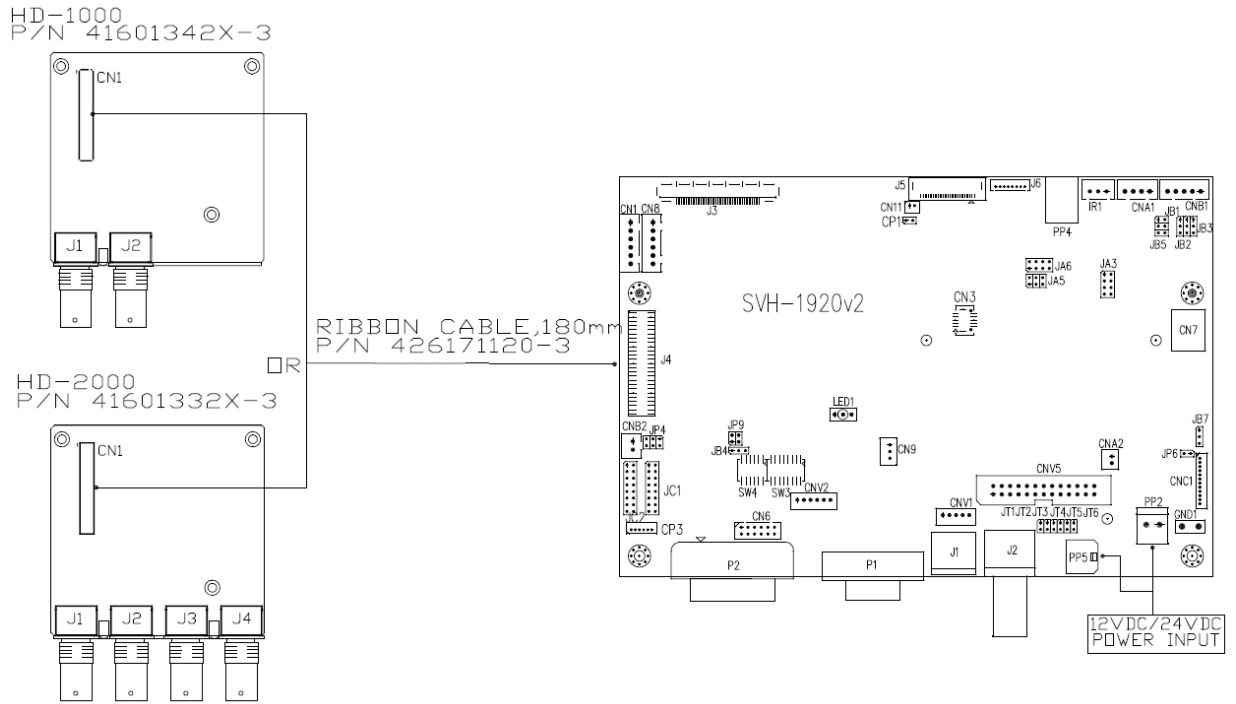

Appendix VIII – Procedure for showing how to select the baud rate

Jumper function :

JC1-3 = Closed : Enable the baud rate selection function

JC1-3 = Open : Disable the baud rate selection function and default set as 2400.

STEP 1 :

Set JC1-3 = closed.

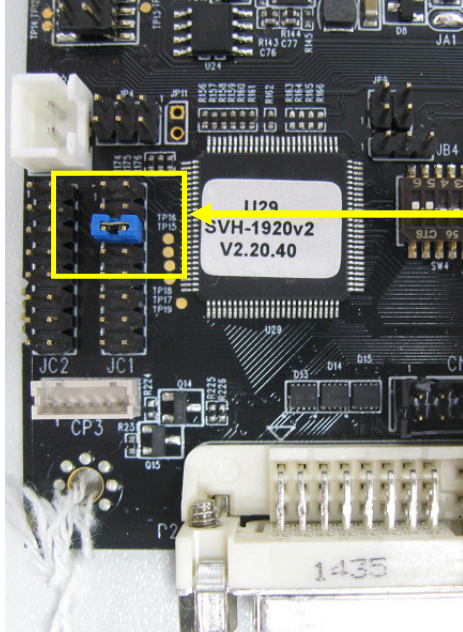

JC1-3 closed to enable the baud rate selection function

STEP 2 :

Press and hold “MENU” button on the OSD switch mount and turn on the controller to enter the “Programming mode”.

“Programming mode” wordings will display on screen on the target programming board. (See below) :

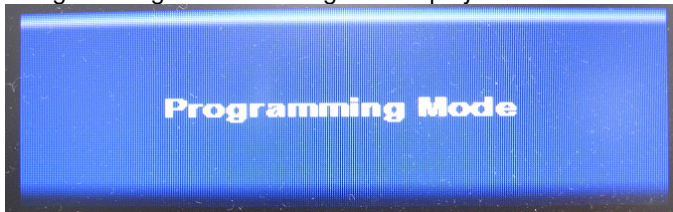

Step 3 : Press “MENU” key to go into the “DDC Programming” & “Set RS232 Baud Rate (CN8)” page. (See below) :

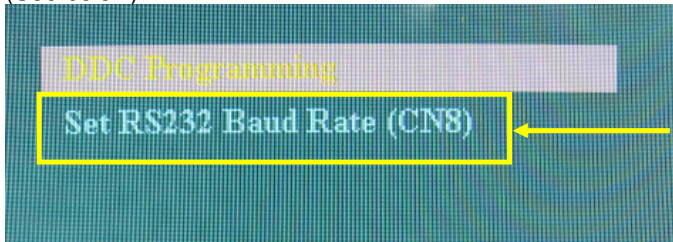

Step 4 : Select “Set RS232 Baud Rate(CN8)” setting, then press “+” to enter the sub menu page.

Step 5 : Choose the appropriate baud rate settings (2400 / 4800 / 9600 / 14400 / 19200 / 38400 / 57600 / 115200).

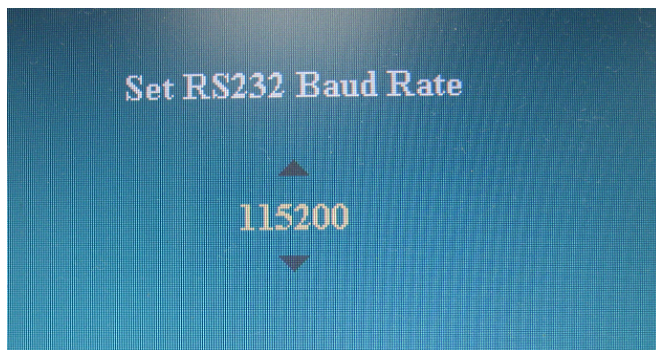
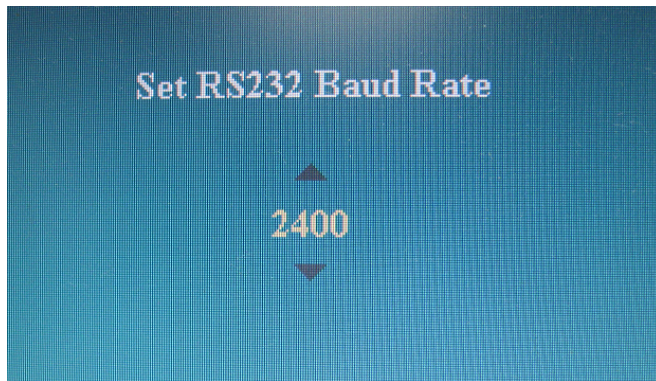

Step 5 : Press "MENU" key to return previous menu.

Step 6 : Shut off the controller

WARRANTY

The products are warranted against defects in workmanship and material for a period of three (3) year from the date of purchase provided no modifications are made to it and it is operated under normal conditions and in compliance with the instruction manual.

The warranty does not apply to:

- Product that has been installed incorrectly, this specifically includes but is not limited to cases where electrical short circuit is caused.
- Product that has been altered or repaired except by the manufacturer (or with the manufacturer's consent).
- Product that has subjected to misuse, accidents, abuse, negligence or unusual stress whether physical or electrical.
- Ordinary wear and tear.

Except for the above express warranties, the manufacturer disclaims all warranties on products furnished hereunder, including all implied warranties of merchantability and fitness for a particular application or purpose. The stated express warranties are in lieu of all obligations or liabilities on the part of the manufacturer for damages, including but not limited to special, indirect consequential damages arising out of or in connection with the use of or performance of the products.

CAUTION

Whilst care has been taken to provide as much detail as possible for use of this product it cannot be relied upon as an exhaustive source of information. This product is for use by suitably qualified persons who understand the nature of the work they are doing and are able to take suitable precautions and design and produce a product that is safe and meets regulatory requirements.

LIMITATION OF LIABILITY

The manufacturer's liability for damages to customer or others resulting from the use of any product supplied hereunder shall in no event exceed the purchase price of said product.

TRADEMARKS

The following are trademarks of Digital View Ltd:

- Digital View
- SVH-1920v2

CONTACT DETAILS

Digital View has offices in Asia, Europe and USA :

USA

Digital View Inc.
18440 Technology Drive
Building 130
Morgan Hill,
California, 95037
USA

Tel: (1) 408-782 7773 **Fax:** (1) 408-782 7883

Sales: ussales@digitalview.com

EUROPE

Digital View Ltd.
The Lake House
Knebworth Park
Herts, SG3 6PY
UK

Tel: +44-(0)20-7631-2150 **Fax:** +44-(0)20-7631-2156

Sales: uksales@digitalview.com

ASIA

Digital View Ltd
Units 705-708, 7/F Texwood Plaza
6 How Ming Street
Kwun Tong
Hong Kong

Tel: (852) 2861 3615 **Fax:** (852) 2520 2987

Sales: hksales@digitalview.com

WEBSITE

www.digitalview.com

Revision History

Date	Rev No.	Page	Summary
30 Oct 2015	1.00	All	First issued
10 Feb 2016	2.00	8 12 19 22 31 44-45	Add "Volume" adjustment function on OSD menu page. Add a remark to state the limitation of the image orientation function. Add the definition of SW3 position 8 for video lock function. - Correct typo for the definition of CNV2 pin 3 is Pb and pin 4 is Pr - Add "Use of memory on board" section in the Specification table. - Add text overlay function RS-232 commands.
29 Apr 2016	3.00	24-25 38	- Revised J4 pin definition - Add default value and range for PIP H position (0xa4) & PIP V position (0xa5) RS-232 command and default PIP size.
15 Aug 2016	4.00	10, 38 19 26	- Add standard Gamma selection (0.6~2.6) support on OSD menu and RS-232 command (0x9d) start effective from V1.18.00.00 firmware version. - Add SVGA & VGA panel timings selection in table 2. - Revised DVI connector (P2) pin 16 to "Hot Plug Detect" pin.
15 Aug 2016	5.00	13 & 22	- Revised matching CNV2 connector to 'PHR-6'
22 Nov 2016	6.00	3, 13, 18, 27 12, 41 12, 37 14 16, 17 19 20	For SVH-1920v2 (P/N 41752004X-3) : - Update PCBA diagram - Add monochrome mode on OSD menu and RS-232 command control. - Add "Image Orientation" on Hotkey 1 & Hotkey 2 on OSD menu and RS-232 command. - Change to use JST B3B-XH-A compatible type connector on LED1. - Add 10V panel power selection jumper on JA3 - Add three new panel timings support on SW3 dip switch setting table done on V1.26.00.00 firmware. - Support "Resolution default by EDID" for different resolution panel.