

APPROVED: \_\_\_\_\_  
 DATE: \_\_\_\_\_ TITLE: \_\_\_\_\_

Rev	AWO #	Description	Date	Appr
-		RELEASED	9/22/21	

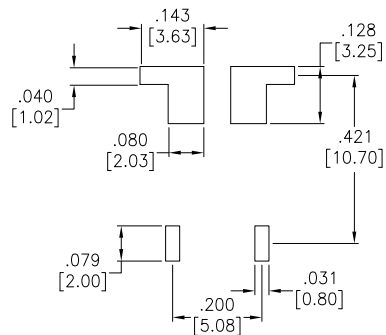

RECOMMENDED PCB LAYOUT

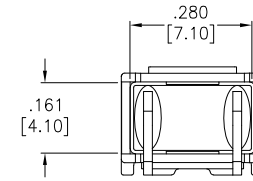
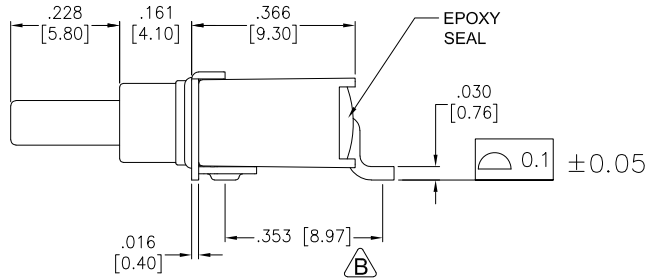
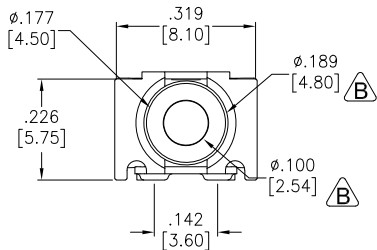
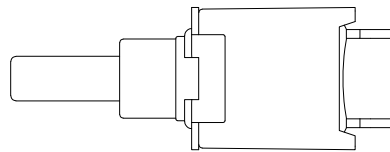
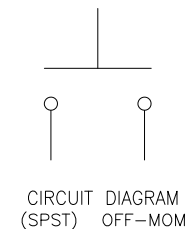
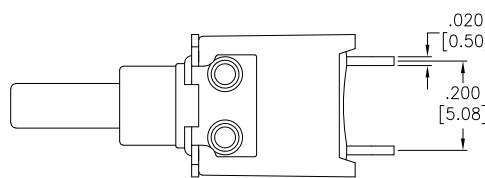

BUTTON POSITION		
FUNCTION	OFF	MOM

SPECIFICATIONS:

Material:  
 Case: PA9T, Rated UL94V-0  
 Plunger: FR52, Rated UL94V-0  
 Bushing: PA9T, Rated UL94V-0  
 Movable Contact: Copper Alloy, Gold over Nickel under plate.  
 Terminal: Copper Alloy, Gold over Nickel under plate.  
 Electrical:  
 Rating: 0.4A max @ 20V AC or DC  
 Contact resistance: 20 mΩ max  
 Insulation resistance: 1,000 Mohms min  
 Dielectric withstanding voltage: 1,500V RMS @Sea level  
 Life: 30,000 cycles at full load  
 Temperature Rating:  
 Operating temperature: -30°C to +85°C  
 Environmental:  
 Sealed IP67 Rated  
 Lead free, RoHS compliant



UNLESS OTHERWISE SPECIFIED ALL DIMENSIONS ARE INCHES [MM]. TOLERANCES: EXCEPT AS NOTED

INCHES	HOLES
.X ± .10	ØX ± .10
.XX ± .020	ØXX ± .015
.XXX ± .015	ØXXX ± .010



909 Rahway Avenue,  
 Union, NJ 07083  
 Phone: 908-687-5000  
 Fax: 908-687-5710

DRAWN	WX	9/22/21
CHECKED	RC	9/22/21
APPROVED		

TITLE  
**SEALED SUB-MINIATURE PUSH BUTTON SWITCH, SPST, OFF-MOM, GOLD PLATED, R/A, SMT**

THIS DRAWING CONTAINS INFORMATION THAT IS PROPRIETARY AND SHOULD NOT BE USED WITHOUT PRIOR WRITTEN PERMISSION FROM ADAM TECH

SIZE	PART NO.	REV.
X	SW-PB9-BBA2RE-7	-
REF:	SCALE: NTS	SHEET 1 OF 1