

PACKAGE DIMENSIONS

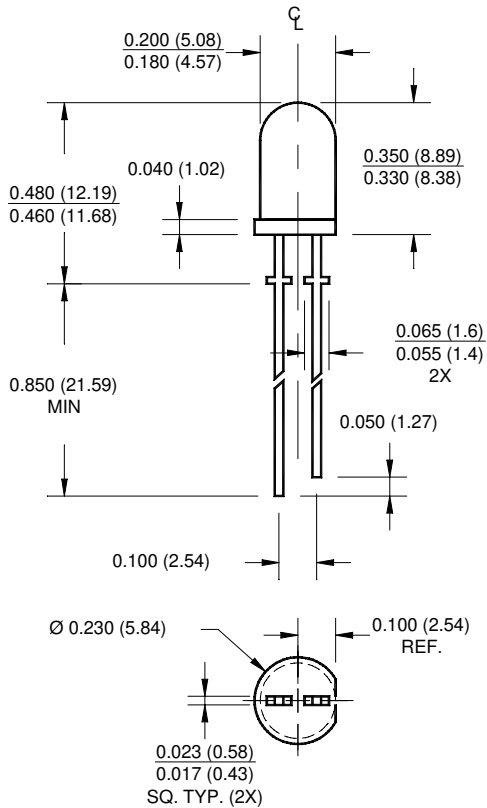

HLMP-3X50A

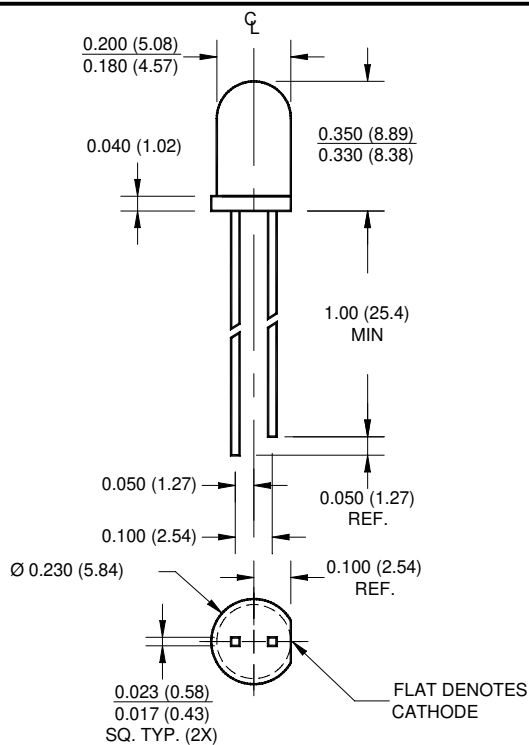

MV3X50

HLMP-3X50A
MV3X50

FEATURES

- Pale tint
- Sturdy leads with or without stand-off on T-1 3/4
- Excellent for small area backlighting
- HER
 - HLMP-3750A
 - MV3750
- Green
 - HLMP-3950A
 - MV3450
- Yellow
 - HLMP-3850A
 - MV3350

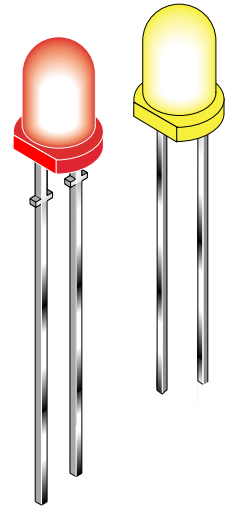

DESCRIPTION

The HLMP-3X50 series consists of tinted and water clear T-1 3/4 LED lamps with standoffs.

The MV3X50 series is the same as Agilent's HLMP-3X50A series, except for the standoffs.

Both series are available in red, yellow and green with a minimum intensity of 80mcd.

NOTES:

ALL DIMENSIONS ARE IN INCHES (mm).

ABSOLUTE MAXIMUM RATING (T_A =25°C)

Parameter	HER	YELLOW	GREEN	UNITS
Power Dissipation	135	85	135	mW
Peak Forward Current	90	60	90	mA
Continuous DC Forward Current	30	20	30	mA
Lead Soldering Time at 260° C	5	5	5	sec
Operating Temperature	-55 to +100	-55 to +100	-50 to +100	°C
Storage Temperature	-55 to +100	-55 to +100	-50 to +100	°C

ELECTRICAL / OPTICAL CHARACTERISTICS (T_A =25°C)

Parameter	MV3750	MV3350	MV3450	Condition
	HLMP-3750A	HLMP-3850A	HLMP-3950A	
Luminous Intensity (mcd)				I _F = 20mA
Minimum	80	80	80	
Typical	150	150	150	
Forward Voltage (V)				I _F = 20mA
Maximum	3.0	3.0	3.0	
Typical	2.2	2.2	2.2	
Peak Wavelength (nm)	635	585	565	I _F = 20mA
Reverse Voltage (V)	5	5	5	I _R = 100μA
Viewing Angle (°)	24	24	24	I _F = 20mA

TYPICAL PERFORMANCE CURVES ($T_A = 25^\circ\text{C}$)

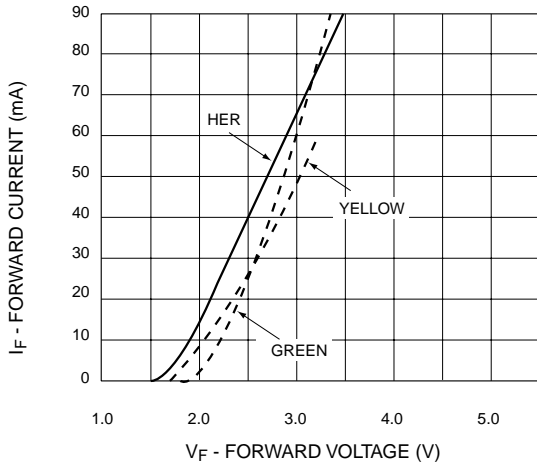

Fig. 1 Forward Current vs. Forward Voltage

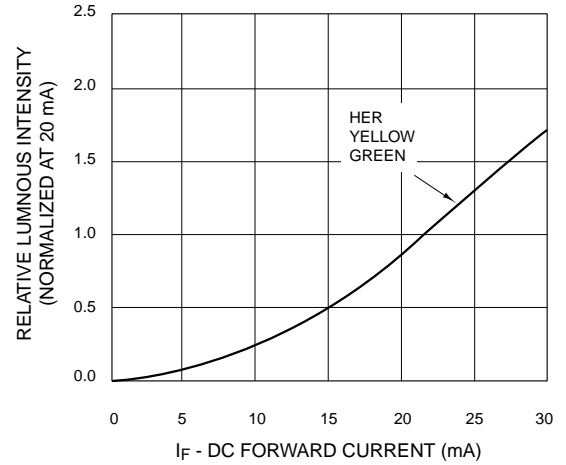

Fig. 2 Relative Luminous Intensity vs. DC Forward Current

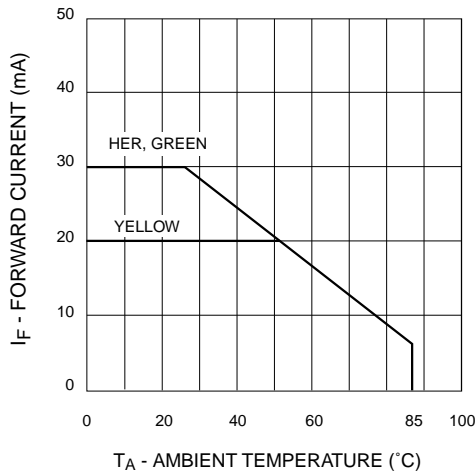

Fig. 3 Current Derating Curve

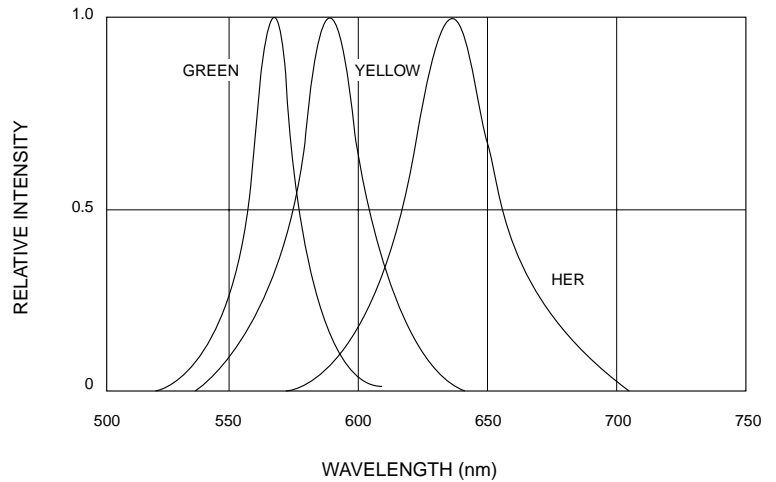

Fig. 4 Relative Intensity vs. Peak Wavelength

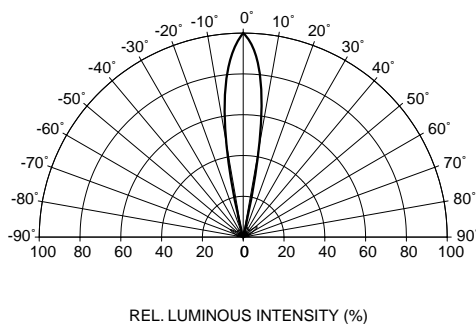

Fig. 5 Radiation Diagram

DISCLAIMER

FAIRCHILD SEMICONDUCTOR RESERVES THE THE RIGHT TO MAKE CHANGES WITHOUT FURTHER NOTICE TO ANY PRODUCTS HEREIN TO IMPROVE RELIABILITY, FUNCTION OR DESIGN. FAIRCHILD DOES NOT ASSUME ANY LIABILITY ARISING OUT OF THE APPLICATION OR USE OF ANY PRODUCT OR CIRCUIT DESCRIBED HEREIN; NEITHER DOES IT CONVEY ANY LICENSE UNDER ITS PATENT RIGHTS, NOR THE RIGHTS OF OTHERS.

LIFE SUPPORT POLICY

FAIRCHILD'S PRODUCTS ARE NOT AUTHORIZED FOR USE AS CRITICAL COMPONENTS IN LIFE SUPPORT DEVICES OR SYSTEMS WITHOUT THE EXPRESS WRITTEN APPROVAL OF THE PRESIDENT OF FAIRCHILD SEMICONDUCTOR CORPORATION. As used herein:

1. Life support devices or systems are devices or systems which, (a) are intended for surgical implant into the body, or (b) support or sustain life, and (c) whose failure to perform when properly used in accordance with instructions for use provided in labeling, can be reasonably expected to result in a significant injury of the user.
2. A critical component in any component of a life support device or system whose failure to perform can be reasonably expected to cause the failure of the life support device or system, or to affect its safety or effectiveness.

Fairchild Semiconductor

SEARCH | [Parametric](#) | [Cross Reference](#) | [Inventory](#)

[Product Folders and](#) [Apply](#)

[find products](#) Home >> [Find products](#) >>

- [Products groups](#)
- [Analog and Mixed](#)
- [Signal](#)
- [Discrete](#)
- [Interface](#)
- [Logic](#)
- [Microcontrollers](#)
- [Non-Volatile](#)
- [Memory](#)
- [Optoelectronics](#)
- [Markets and applications](#)
- [New products](#)
- [Product selection and parametric search](#)
- [Cross-reference search](#)

MV3350
Green T-1 3/4 (5 mm) Solid State Lamp

Contents
[General description](#) | [Features](#) | [Testing conditions](#) | [Product status/pricing/packaging](#)

General description

The HLMP-3X50 series consists of tinted and water clear T-1 3/4 LED lamps with standoffs.

The MV3X50 series in the same as Agilent's HLMP-3X50A series, except for the standoffs.

Both series are available in red, yellow and green with a minimum intensity of 80mcd.

Datasheet
[Download this datasheet](#)



[e-mail this datasheet](#)



This page
[Print version](#)

Related Links

- [Request samples](#)
- [How to order products](#)
- [Product Change Notices \(PCNs\)](#)
- [Support](#)
- [Distributor and field sales representatives](#)
- [Quality and reliability](#)
- [Design tools](#)

- [technical information](#)
- [buy products](#)
- [technical support](#)
- [my Fairchild](#)
- [company](#)

[back to top](#)

Features

- Pale tint.
- Sturdy leads with or without stand-off on T-1 3/4
- Excellent for small area backlighting
- High Efficiency Red - HLMP-3750A - MV3750
- Green - HLMP-3950A - MV3450
- Yellow - HLMP-3850A - MV3350

[back to top](#)

Testing conditions

- $V_F @ I_F = 20 \text{ mA}; I_V @ I_F = 20 \text{ mA}$

[back to top](#)

Product status/pricing/packaging

Product	Product status	Pricing*	Inventory check & ordering	Package type	Packing method
MV33509.MP6NC	Full Production	\$117647.0587	Purchase	T-1 3/4	BOX
MV33509.MP93	Full Production	\$0.334	Purchase	T-1 3/4	BOX
MV3350.B4R0	Full Production	\$0.058	Purchase	T-1 3/4	BOX
MV3350	Full Production	\$0.051	Purchase	T-1 3/4	BOX
MV3350.B4R1	Full Production	N/A	Purchase	T-1 3/4	BOX
MV3350.A2R0	Full Production	\$0.058	Purchase	T-1 3/4	BOX
MV33509.MP5	Full Production	\$0.141	Purchase	T-1 3/4	BOX
MV33509.MP6	Full Production	\$0.141	Purchase	T-1 3/4	BOX
MV33509.MP8A	Full Production	\$0.58	Purchase	T-1 3/4	BOX
MV33509.MP7	Full Production	\$0.167	Purchase	T-1 3/4	BOX
MV33509.MP8	Full Production	\$0.58	Purchase	T-1 3/4	BOX
MV33509.MP8B	Full Production	\$0.58	Purchase	T-1 3/4	BOX
MV3350.A4R0	Full Production	\$0.058	Purchase	T-1 3/4	BOX
MV3350.B6R1	Full Production	N/A	Purchase	T-1 3/4	BOX

* Fairchild 1,000 piece Budgetary Pricing

[back to top](#)

[Home](#) | [Find products](#) | [Technical information](#) | [Buy products](#) | [Support](#) | [Company](#) | [Contact us](#) | [Site index](#) | [Privacy policy](#)

© Copyright 2002 Fairchild Semiconductor

Fairchild Semiconductor

SEARCH | [Parametric](#) | [Cross Reference](#) | [Inventory](#)

[Product Folders and](#) [Apply](#)

[find products](#) Home >> [Find products](#) >>

- [Products groups](#)
- [Analog and Mixed Signal](#)
- [Discrete](#)
- [Interface](#)
- [Logic](#)
- [Microcontrollers](#)
- [Non-Volatile](#)
- [Memory](#)
- [Optoelectronics](#)
- [Markets and applications](#)
- [New products](#)
- [Product selection and parametric search](#)
- [Cross-reference search](#)

- [technical information](#)
- [buy products](#)
- [technical support](#)
- [my Fairchild](#)
- [company](#)

MV3450
High Efficiency Red T-1 3/4 (5 mm) Solid State Lamp

Contents
[General description](#) | [Features](#) | [Testing conditions](#) | [Product status/pricing/packaging](#)

General description

The HLMP-3X50 series consists of tinted and water clear T-1 3/4 LED lamps with standoffs.

The MV3X50 series in the same as Agilent's HLMP-3X50A series, except for the standoffs.

Both series are available in red, yellow and green with a minimum intensity of 80mcd.

[back to top](#)

Features

- Pale tint.
- Sturdy leads with or without stand-off on T-1 3/4
- Excellent for small area backlighting
- High Efficiency Red - HLMP-3750A - MV3750
- Green - HLMP-3950A - MV3450
- Yellow - HLMP-3850A - MV3350

[back to top](#)

Testing conditions

- $V_F @ I_F = 20 \text{ mA}$; $I_V @ I_F = 20 \text{ mA}$

Datasheet
[Download this datasheet](#)



[e-mail this datasheet](#)



This page
[Print version](#)

Related Links

- [Request samples](#)
- [How to order products](#)
- [Product Change Notices \(PCNs\)](#)
- [Support](#)
- [Distributor and field sales representatives](#)
- [Quality and reliability](#)
- [Design tools](#)

[back to top](#)

Product status/pricing/packaging

Product	Product status	Pricing*	Inventory check & ordering	Package type	Packing method
MV3450	Full Production	\$0.051	Purchase	T-1 3/4	BOX
MV3450.A4R0	Full Production	\$0.058	Purchase	T-1 3/4	BOX
MV3450.A2A0	Full Production	\$0.058	Purchase	T-1 3/4	BOX
MV34509.MP94	Full Production	\$0.334	Purchase	T-1 3/4	BOX
MV34509.MP8B	Full Production	\$0.58	Purchase	T-1 3/4	BOX
MV34509.MP8	Full Production	\$0.58	Purchase	T-1 3/4	BOX
MV34509.MP5	Full Production	\$0.141	Purchase	T-1 3/4	BOX
MV34509.MP8A	Full Production	\$0.58	Purchase	T-1 3/4	BOX
MV3450.B4R0	Full Production	\$0.058	Purchase	T-1 3/4	BOX
MV3450.B6R1	Full Production	N/A	Purchase	T-1 3/4	BOX
MV3450.B4R1	Full Production	N/A	Purchase	T-1 3/4	BOX
MV34509.MP6	Full Production	\$0.141	Purchase	T-1 3/4	BOX
MV34509.MP7	Full Production	\$0.167	Purchase	T-1 3/4	BOX
MV3450.A2R0	Full Production	\$0.058	Purchase	T-1 3/4	BOX
MV3450.A3R0	Full Production	\$0.058	Purchase	T-1 3/4	BOX

* Fairchild 1,000 piece Budgetary Pricing

[back to top](#)

[Home](#) | [Find products](#) | [Technical information](#) | [Buy products](#) | [Support](#) | [Company](#) | [Contact us](#) | [Site index](#) | [Privacy policy](#)

© Copyright 2002 Fairchild Semiconductor

Fairchild Semiconductor

SEARCH | [Parametric](#) | [Cross Reference](#) | [Inventory](#)

[Product Folders and](#) [Apply](#)

[find products](#) Home >> [Find products](#) >>

- [Products groups](#)
- [Analog and Mixed Signal](#)
- [Discrete](#)
- [Interface](#)
- [Logic](#)
- [Microcontrollers](#)
- [Non-Volatile](#)
- [Memory](#)
- [Optoelectronics](#)
- [Markets and applications](#)
- [New products](#)
- [Product selection and parametric search](#)
- [Cross-reference search](#)

- [technical information](#)
- [buy products](#)
- [technical support](#)
- [my Fairchild](#)
- [company](#)

MV3750
 High Efficiency Green/AlGaAs Red
 Rectangular Solid State Lamp

Contents
[General description](#) | [Features](#) | [Testing conditions](#) | [Product status/pricing/packaging](#)

General description

The HLMP-3X50 series consists of tinted and water clear T-1 3/4 LED lamps with standoffs.

The MV3X50 series in the same as Agilent's HLMP-3X50A series, except for the standoffs.

Both series are available in red, yellow and green with a minimum intensity of 80mcd.

[back to top](#)

Features

- Pale tint.
- Sturdy leads with or without stand-off on T-1 3/4
- Excellent for small area backlighting
- High Efficiency Red - HLMP-3750A - MV3750
- Green - HLMP-3950A - MV3450
- Yellow - HLMP-3850A - MV3350

[back to top](#)

Testing conditions

- $V_F @ I_F = 20 \text{ mA}$; $I_V @ I_F = 20 \text{ mA}$

Datasheet
[Download this datasheet](#)



[e-mail this datasheet](#)



This page
[Print version](#)

Related Links

- [Request samples](#)
- [How to order products](#)
- [Product Change Notices \(PCNs\)](#)
- [Support](#)
- [Distributor and field sales representatives](#)
- [Quality and reliability](#)
- [Design tools](#)

[back to top](#)

Product status/pricing/packaging

Product	Product status	Pricing*	Inventory check & ordering	Package type	Packing method
MV37509.MP6	Full Production	\$0.141	Purchase	T-1 3/4	BOX
MV3750.A2R0	Full Production	\$0.058	Purchase	T-1 3/4	BOX
MV3750.A1R0	Full Production	N/A	Purchase	T-1 3/4	BOX
MV37509.MP5	Full Production	\$0.141	Purchase	T-1 3/4	BOX
MV37509.MP8A	Full Production	\$0.58	Purchase	T-1 3/4	BOX
MV3750.A6A1	Full Production	N/A	Purchase	T-1 3/4	BOX
MV3750.A3A0	Full Production	\$0.058	Purchase	T-1 3/4	BOX
MV37509.MP7	Full Production	\$0.167	Purchase	T-1 3/4	BOX
MV3750	Full Production	\$0.051	Purchase	T-1 3/4	BOX
MV37509.MP8B	Full Production	\$0.58	Purchase	T-1 3/4	BOX
MV3750.A5R0	Full Production	\$0.058	Purchase	T-1 3/4	BOX
MV3750.A3R0	Full Production	\$0.058	Purchase	T-1 3/4	BOX
MV37509.MP97	Full Production	\$0.334	Purchase	T-1 3/4	BOX
MV37509.MP8	Full Production	\$0.58	Purchase	T-1 3/4	BOX
MV3750.B4R0	Full Production	\$0.058	Purchase	T-1 3/4	BOX
MV3750.B6R1	Full Production	N/A	Purchase	T-1 3/4	BOX

* Fairchild 1,000 piece Budgetary Pricing

[back to top](#)

[Home](#) | [Find products](#) | [Technical information](#) | [Buy products](#) | [Support](#) | [Company](#) | [Contact us](#) | [Site index](#) | [Privacy policy](#)

© Copyright 2002 Fairchild Semiconductor
