

## Introduction

This user guide describes how to get started with the Atmel® REB233-XPRO extension board.

The extension boards is targeted for evaluating the features of the Atmel AT86RF233 radio transceiver.

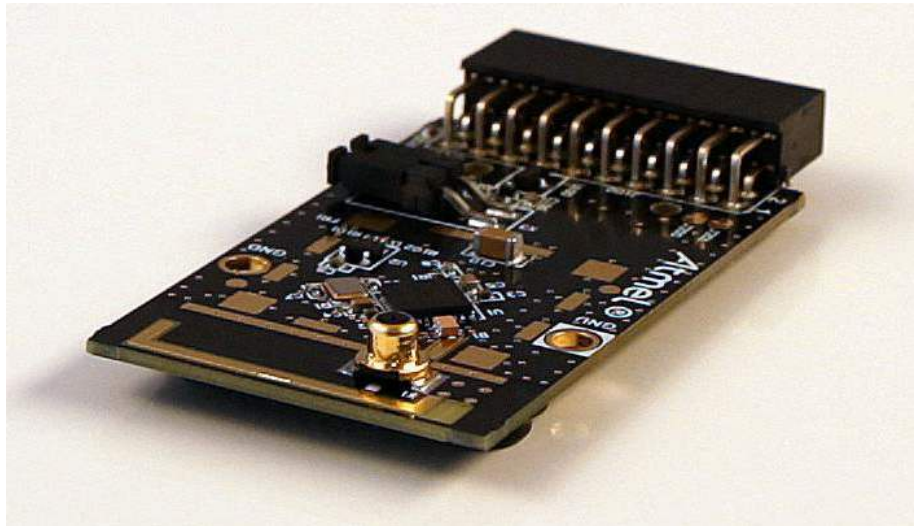

## Table of Contents

---

Introduction .....	1
<b>1. Getting Started .....</b>	<b>3</b>
1.1. Features .....	3
1.2. Design Documentation and Related Links .....	3
1.3. Board Assembly .....	3
1.3.1. Connect to a Xplained Pro Board .....	3
1.3.2. In Customer Development Assembly .....	3
<b>2. Performance Analyzer .....</b>	<b>4</b>
2.1. Introduction .....	4
2.2. Program Installation .....	4
2.3. Program Use .....	7
2.4. Typical Wireless Nodes .....	7
<b>3. Xplained Pro .....</b>	<b>9</b>
3.1. Hardware Identification System .....	9
3.2. Standard Headers and Connectors .....	9
3.2.1. Xplained Pro Standard Extension Header .....	9
<b>4. Hardware User Guide .....</b>	<b>11</b>
4.1. Board Overview .....	11
4.2. Headers and Connectors .....	11
4.2.1. J100 Xplained Pro Extension Connector .....	11
4.2.2. Current Monitoring (X3) .....	12
4.3. U2 Serial EEPROM .....	12
<b>5. Persistence Memory .....</b>	<b>13</b>
<b>6. Agency Certifications .....</b>	<b>14</b>
6.1. United State (FCC) .....	14
6.2. European Union (ETSI) .....	14
6.3. Canada (IC) .....	15
6.4. Using Limited Modular Certified Products .....	15
<b>7. Document revision history .....</b>	<b>17</b>

# 1. Getting Started

## 1.1 Features

The REB233 extension is a template design for the AT86RF233 with a PCB antenna.

## 1.2 Design Documentation and Related Links

[The most relevant documents and software for the extension board<sup>1</sup>.](#)

## 1.3 Board Assembly

The extension board can be used to provide wireless communication to a Xplained PRO board or to provide wireless communication to your own prototype for SW development and HW verification.

### 1.3.1 Connect to a Xplained Pro Board

The Extension board can be connected to any Xplained PRO main board using the extension header.

### 1.3.2 In Customer Development Assembly

The Extension board can be wired into the customer prototype assembly by using the on-board connectors, all relevant signals are available.

---

<sup>1</sup> <http://www.atmel.com/tools/reb233-xpro.aspx>

## 2. Performance Analyzer

### 2.1 Introduction

The Performance Analyzer FW together with the GUI in Atmel Studio Wireless Composer Extension provides a number of basic functional RF tests.

A quick start guide and general help is provided in Wireless Composer once started.

### 2.2 Program Installation

How to install necessary SW.

1. Install [Atmel Studio](http://www.atmel.com/tools/atmelstudio.aspx)<sup>1</sup>.
2. Once Studio is installed and started use the Tools - Extension Manager to install the Wireless Composer.

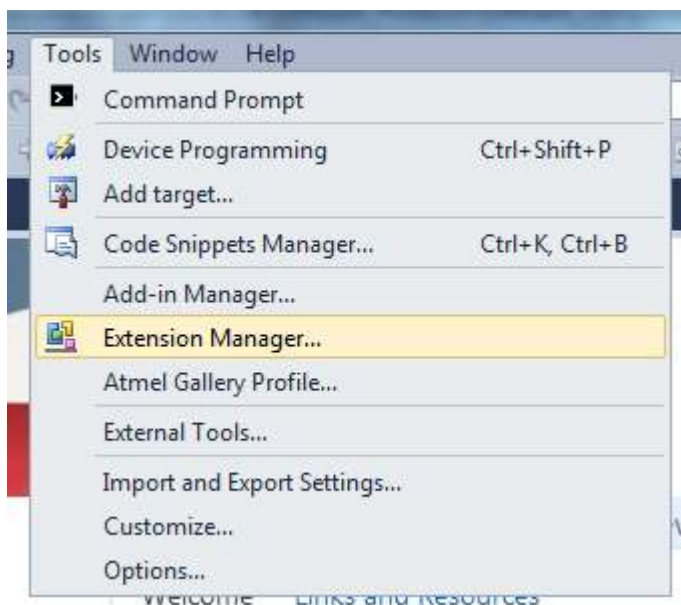

Select Wireless and Wireless Composer.

<sup>1</sup> <http://www.atmel.com/tools/atmelstudio.aspx>

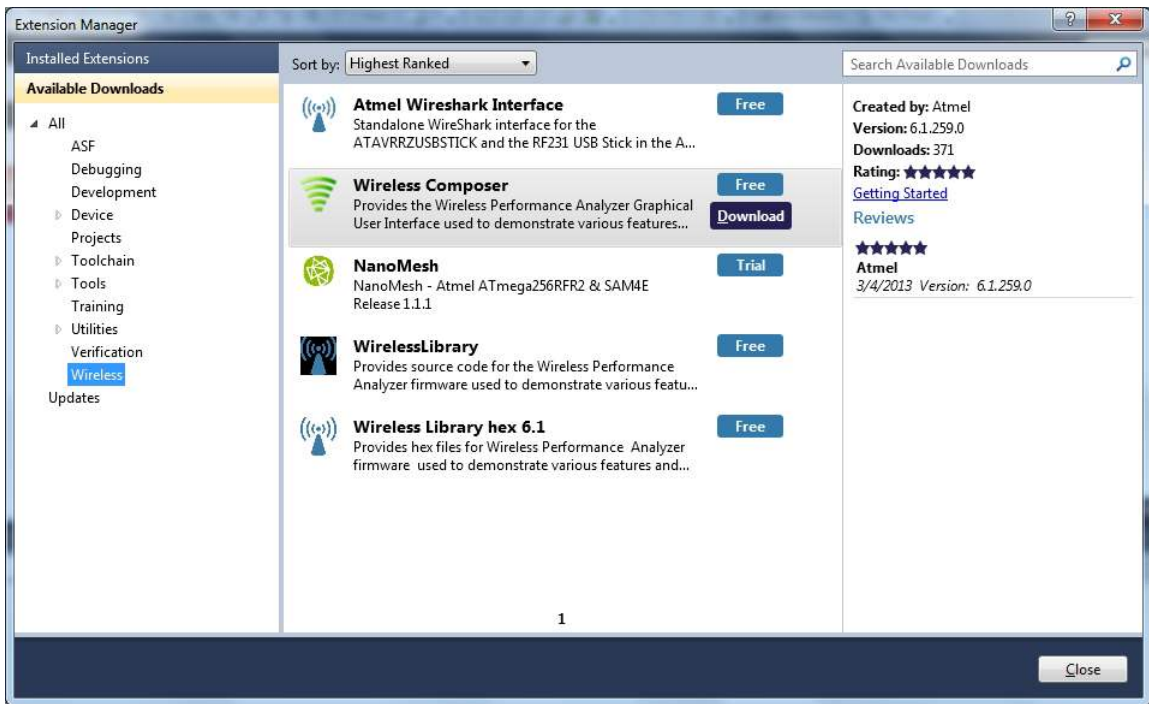

Log in to Atmel Gallery.

Click download again and download starts.

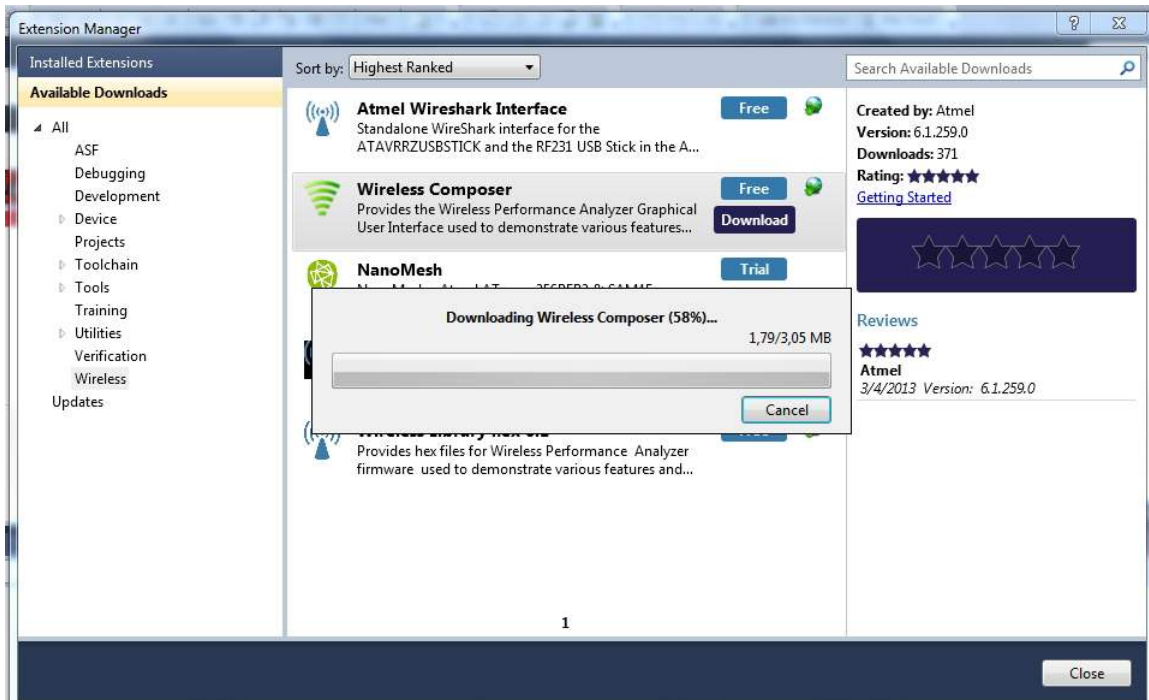

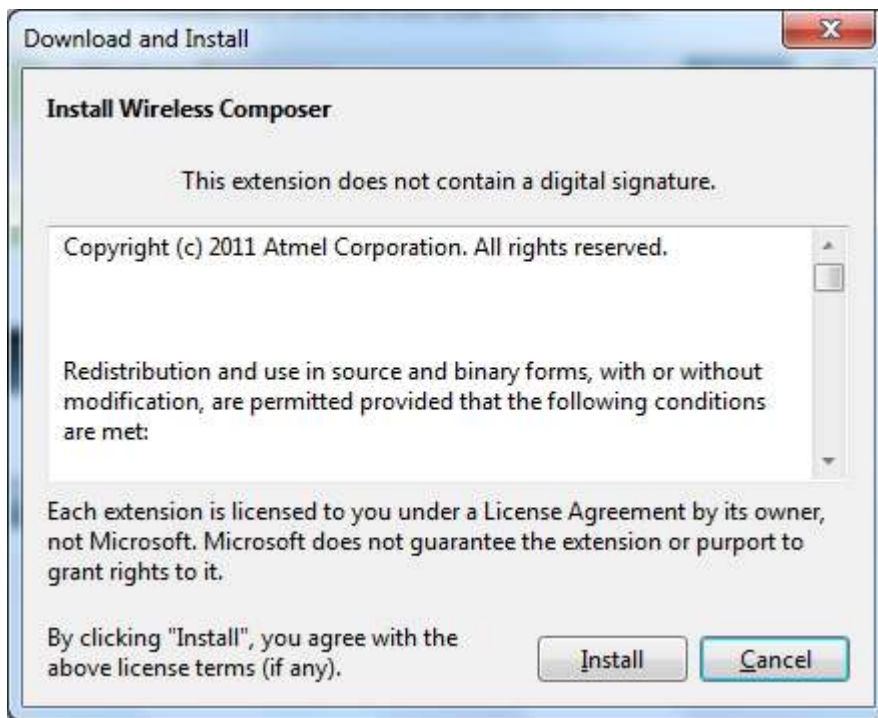

Restart Atmel Studio, allow help to make changes and the Performance Analyzer GUI is available in the Tools menu.

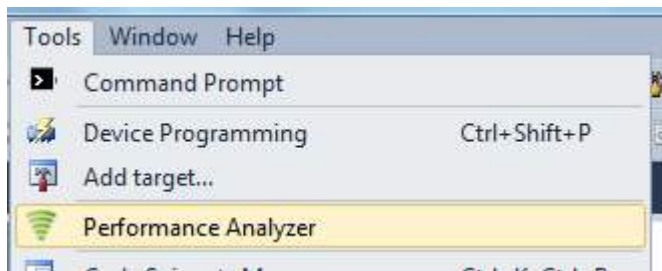

3. If not already preprogrammed - program the node with the Performance Analyzer FW available in the "Wireless Performance Analyzer Firmware extension" or from source code provided in ASF.

If using an Wireless board with a  $\mu$ C embedded, the Performance Analyzer FW has to be programmed using the Bootloader or JTAGICE.

If using a extension board which do not have a  $\mu$ C embedded, the Performance Analyzer FW has to be programmed on the Xplained Pro board using the EBDG from Atmel Studio.

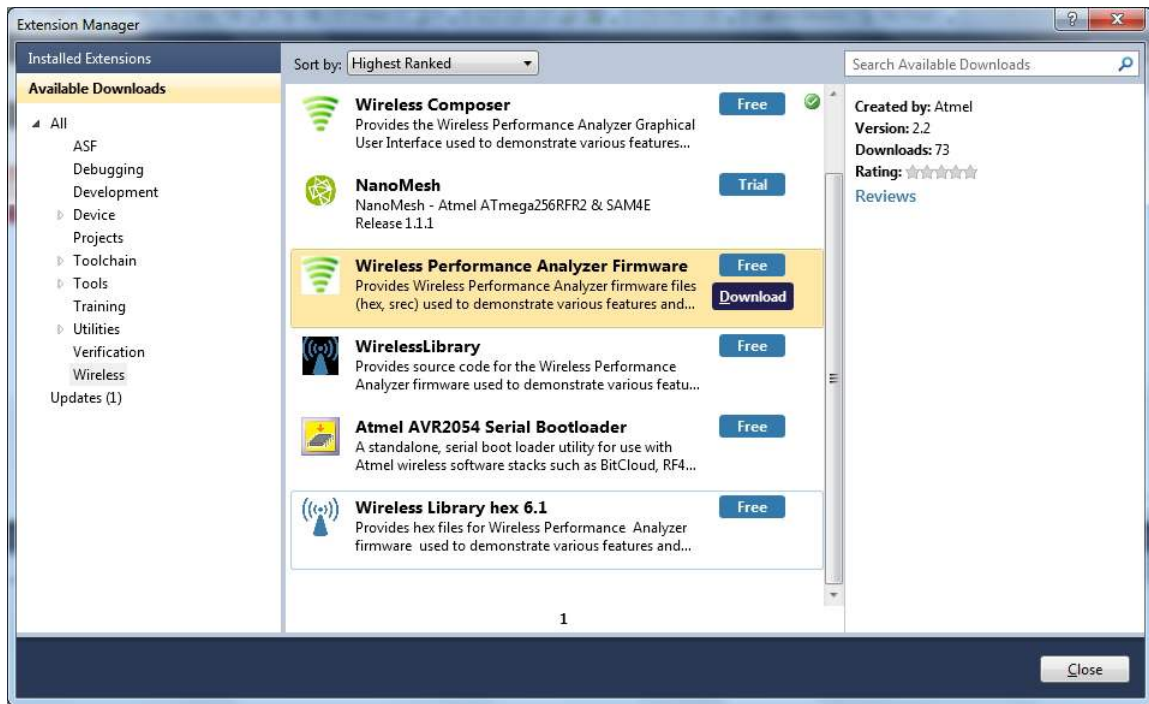

## 2.3 Program Use

How to get started.

1. Connect the Wireless board assembly, with the Performance Analyzer FW programmed, to the PC USB connector and power on, a COM port should now be available for the kit.
2. Power on any other wireless node assemblies of similar frequency, running the Performance Analyzer FW, and use it as a reference.
3. Start Performance Analyzer GUI, connect to the kit via the COM port and follow the quick start guide.

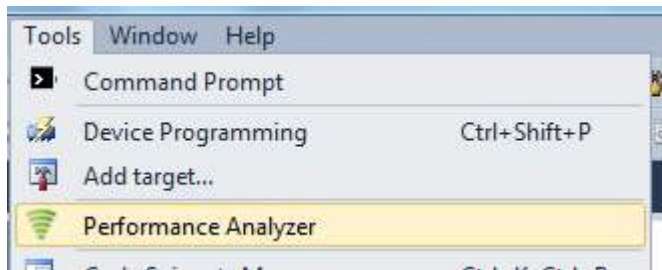

## 2.4 Typical Wireless Nodes

Typical board assembly.

The Atmel SAM4L Xplained Pro Evaluation Kit with Wireless Extension and remote node consisting of a Wireless extension board and a battery pack.



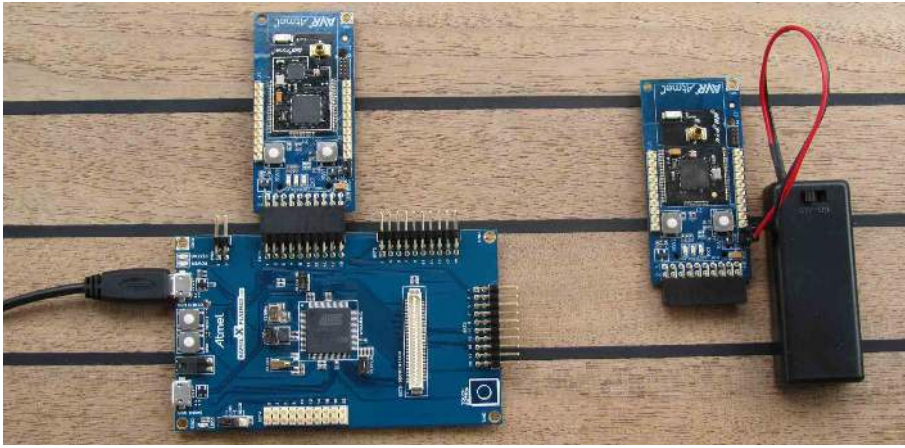

The Atmel ATmega256RFR2 Xplained Pro Evaluation Kit and remote node consisting of a Wireless extension board and a battery pack.

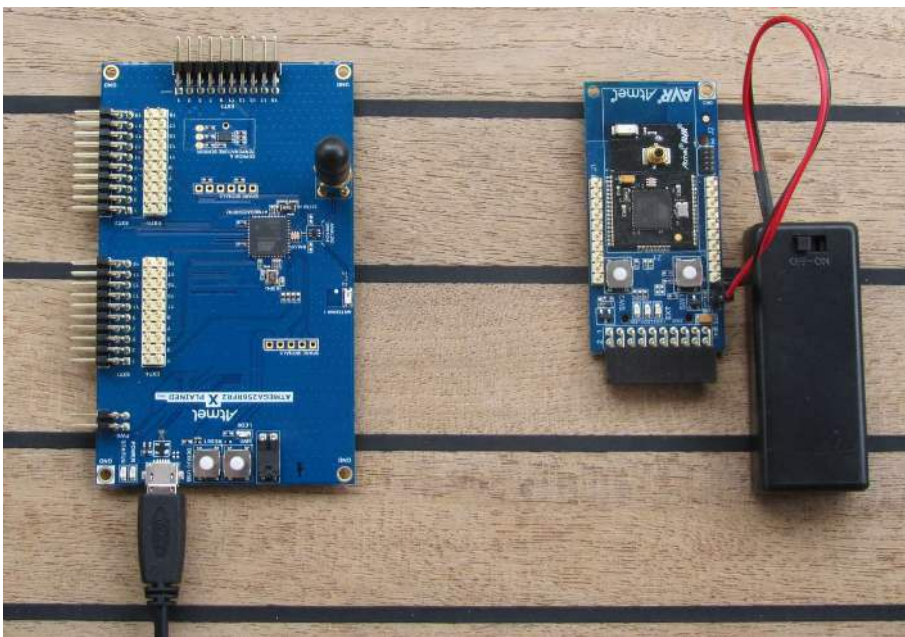



## 3. Xplained Pro

Xplained Pro is an evaluation platform that provides the full Atmel microcontroller experience. The platform consists of a series of Microcontroller (MCU) boards and extension boards that are integrated with Atmel Studio, have Atmel Software Framework (ASF) drivers and demo code, support data streaming and more. Xplained Pro MCU boards support a wide range of Xplained Pro extension boards that are connected through a set of standardized headers and connectors. Each extension board has an identification (ID) chip to uniquely identify which boards are mounted on a Xplained Pro MCU board. This information is used to present relevant user guides, application notes, datasheets and example code through Atmel Studio. Available Xplained Pro MCU and extension boards can be purchased in the [Atmel Web Store](#)<sup>1</sup>.

### 3.1 Hardware Identification System

All Xplained Pro compatible extension boards have an Atmel ATSHA204 CryptoAuthentication™ chip mounted. This chip contains information that identifies the extension with its name and some extra data. When an Xplained Pro extension board is connected to an Xplained Pro MCU board the information is read and sent to Atmel Studio. The Atmel Kits extension, installed with Atmel Studio, will give relevant information, code examples and links to relevant documents. [Table 3-1, “Xplained Pro ID Chip Content” on page 9](#) shows the data fields stored in the ID chip with example content.

**Table 3-1. Xplained Pro ID Chip Content**

Data Field	Data Type	Example Content
Manufacturer	ASCII string	Atmel'\0'
Product Name	ASCII string	Segment LCD1 Xplained Pro'\0'
Product Revision	ASCII string	02'\0'
Product Serial Number	ASCII string	1774020200000010'\0'
Minimum Voltage [mV]	uint16_t	3000
Maximum Voltage [mV]	uint16_t	3600
Maximum Current [mA]	uint16_t	30

### 3.2 Standard Headers and Connectors

#### 3.2.1 Xplained Pro Standard Extension Header

All Xplained Pro kits have one or more dual row, 20-pin, 100mil extension headers. Xplained Pro MCU boards have male headers while Xplained Pro extensions have their female counterparts. Note that all pins are not always connected. However, all the connected pins follow the defined pin-out described in [Table 3-2, “Xplained Pro Extension Header” on page 9](#). The extension headers can be used to connect a wide variety of Xplained Pro extensions to Xplained Pro MCU boards and to access the pins of the target MCU on Xplained Pro MCU board directly.

**Table 3-2. Xplained Pro Extension Header**

Pin number	Name	Description
1	ID	Communication line to the ID chip on extension board.
2	GND	Ground.
3	ADC(+)	Analog to digital converter , alternatively positive part of differential ADC.
4	ADC(-)	Analog to digital converter , alternatively negative part of differential ADC.
5	GPIO1	General purpose I/O.
6	GPIO2	General purpose I/O.
7	PWM(+)	Pulse width modulation , alternatively positive part of differential PWM.
8	PWM(-)	Pulse width modulation , alternatively positive part of differential PWM.

<sup>1</sup> <http://store.atmel.com/CBC.aspx?q=c:100113>

Pin number	Name	Description
9	IRQ/GPIO	Interrupt request line and/or general purpose I/O.
10	SPI_SS_B/GPIO	Slave select for SPI and/or general purpose I/O.
11	TWI_SDA	Data line for two-wire interface. Always implemented, bus type.
12	TWI_SCL	Clock line for two-wire interface. Always implemented, bus type.
13	USART_RX	Receiver line of Universal Synchronous and Asynchronous serial Receiver and Transmitter.
14	USART_TX	Transmitter line of Universal Synchronous and Asynchronous serial Receiver and Transmitter.
15	SPI_SS_A	Slave select for SPI. Should be unique if possible.
16	SPI_MOSI	Master out slave in line of Serial peripheral interface. Always implemented, bus type.
17	SPI_MISO	Master in slave out line of Serial peripheral interface. Always implemented, bus type.
18	SPI_SCK	Clock for Serial peripheral interface. Always implemented, bus type.
19	GND	Ground.
20	VCC	Power for extension board.

## 4. Hardware User Guide

### 4.1 Board Overview

Figure 4-1. Board overview

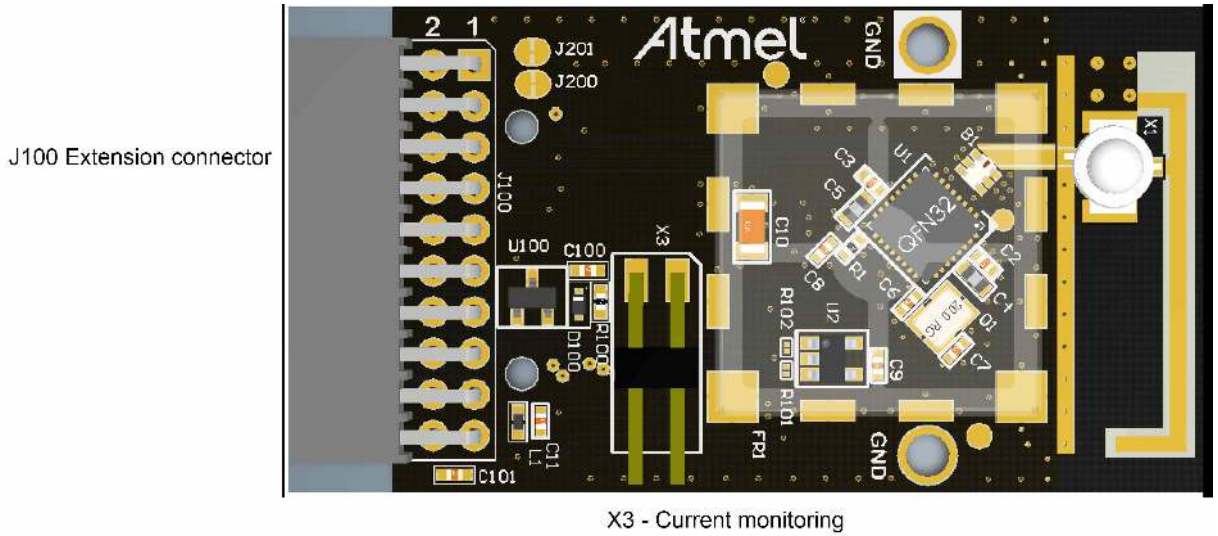

### 4.2 Headers and Connectors

The extension board connectors.

#### 4.2.1 J100 Xplained Pro Extension Connector

The Xplained Pro extension connectors, used to connect the extension board to the Xplained Pro board.

Table 4-1. J100 Xplained Pro Extension Header

Pin	Name	RF233		Description
		Pin	Name	
1	ID			Communication line to the ID chip on the extension board.
2	GND			Ground.
3	ADC(+)	9	DIG1	DIG1 via J201 enabling disconnection from J100.
4	ADC(-)	1	DIG3	DIG3 via J200 enabling disconnection from J100.
5	GPIO1	10	DIG2	DIG2.
6	GPIO2	17	CLKM	CLK_OUT - can be disconnected by not mounting R6.
7	PWM(+)	8	RSTN	RESET to Extension board.
8	PWM(-)			
9	IRQ/GPIO	24	IRQ	Interrupt request line to uC on Xplained Pro board.
10	SPI_SS_B/ GPIO	11	SLP_TR	Wake up interrupt to RF.
11	TWI_SDA		EEPROM	Data line for the two wire interface to AT24MAC602 serial EEPROM.
12	TWI_SCL		EEPROM	Clock line for the two wire interface to AT24MAC602 serial EEPROM.

Pin	Name	RF233		Description
		Pin	Name	
13	USART_RX			
14	USART_TX			
15	SPI_SS_A	23	SEL	Slave select for SPI. Should be unique if possible.
16	SPI_MOSI	22	MOSI	Master out slave in line of Serial peripheral interface. Always implemented, bus type.
17	SPI_MISO	20	MISO	Master in slave out line of Serial peripheral interface. Always implemented, bus type.
18	SPI_SCK	19	SCLK	Clock for Serial peripheral interface. Always implemented, bus type.
19	GND			Ground.
20	VCC			Power for extension board.

#### 4.2.2 Current Monitoring (X3)

X3 enables current monitoring using an external multimeter.

Connect multimeter between X3-1 and X3-2 to measure the current used by the AT86RF233.

#### Warning

When **not** monitoring current the strap need to be inserted in order to provide power to the board.

Figure 4-2. X3 Current Monitor

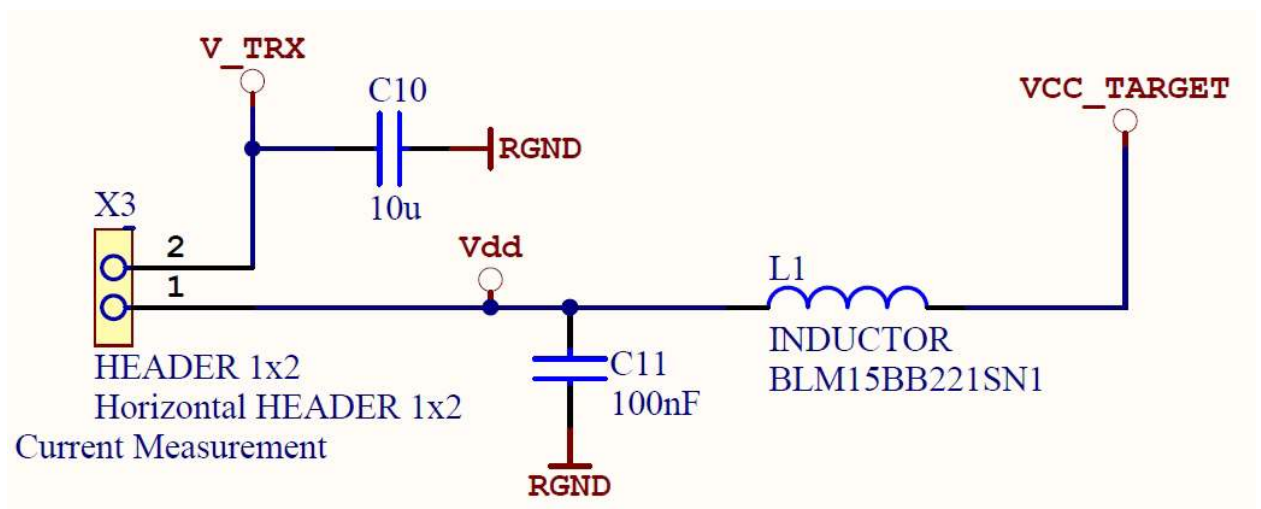

Table 4-2. X3 Current Measurement

X3 Pin	Function
1 - Vdd	3.3V pin on the J100 via L1.
2 - V_TRX	3.3V pin on the AT86RF233.

#### 4.3 U2 Serial EEPROM

The REB233 contains a serial EEPROM, AT24MAC602, with factory programmed MAC addresses available via the I2C interface of J100.

The memory organisation is as documented in [“Persistence Memory” on page 13](#). The structure is located from EEPROM address 0x00, device address ‘1010’

## 5. Persistence Memory

A dedicated memory space is allocated to store product specific information and called the Persistence Memory. The organization of the persistence memory is as follows:

**Table 5-1. Persistence Memory**

Data	Size
Structure Revision	2 bytes
MAC address	8 bytes
Board information – PCBA Name	30 bytes
Board information – PCBA Serial number	10 bytes
Board information – PCBA Atmel Part Number	8 bytes
Board information – PCBA Revision	1 byte
XTAL Calibration Value	1 byte
Reserved	7 bytes
Reserved	4 bytes
CRC	1 bytes

The MAC address stored inside the MCU is a uniquely assigned ID for each ZigBit® and owned by Atmel. User of the ZigBit application can use this unique MAC ID to address the ZigBit in end-applications. The MAC ID can be read from the ZigBit using the Performance Analyzer Application that is supplied through Atmel Studio Gallery Extension.

## 6. Agency Certifications

### 6.1 United State (FCC)

This equipment complies with Part 15 of the FCC rules and regulations. To fulfill FCC Certification requirements, an OEM manufacturer must comply with the following regulations:

1. The ATREB233-XPRO modular transmitter must be labelled with its own FCC ID number, and, if the FCC ID is not visible when the module is installed inside another device, then the outside of the device into which the module is installed must also display a label referring to the enclosed module. This exterior label can use wording such as the following:

#### Important

---

Contains FCC ID : VW4A091887. This equipment complies with Part 15 of the FCC Rules. Operation is subject to the following two conditions:

- (1) this device may not cause harmful interference, and
  - (2) this device must accept any interference received, including interference that may cause undesired operation (FCC 15.19)
- 

The internal antenna used for this mobile transmitter must provide a separation distance of at least 20 cm from all persons and must not be co-located or operating in conjunction with any other antenna or transmitter. Installers must be provided with antenna installation instructions and transmitter operating conditions for satisfying RF exposure compliance. This device is approved as a mobile device with respect to RF exposure compliance, and may only be marketed to OEM installers. Use in portable exposure conditions (FCC 2.1093) requires separate equipment authorization.

#### Important

---

Modifications not expressly approved by this company could void the user's authority to operate this equipment (FCC section 15.21).

---

#### Important

---

This equipment has been tested and found to comply with the limits for a Class A digital device, pursuant to Part 15 of the FCC Rules. These limits are designed to provide reasonable protection against harmful interference when the equipment is operated in a commercial environment. This equipment generates, uses, and can radiate radio frequency energy and, if not installed and used in accordance with the instruction manual, may cause harmful interference to radio communications. Operation of this equipment in a residential area is likely to cause harmful interference in which case the user will be required to correct the interference at his own expense (FCC section 15.105).

---

ATREB233-XPRO is limited modular approved and required separate approval for this module when used on an application board.

Cet appareil est conforme à la section 15 des réglementations de la FCC. Le fonctionnement de l'appareil est sujet aux deux conditions suivantes:

- (1) cet appareil ne doit pas provoquer d'interférences néfastes, et
- (2) cet appareil doit tolérer les interférences reçues, y compris celles qui risquent de provoquer un fonctionnement indésirable

### 6.2 European Union (ETSI)

The ATREB233-XPRO Module has been certified for use in European Union countries. If these modules are incorporated into a product, the manufacturer must ensure compliance of the final product to the European harmonized EMC and low voltage/safety standards. A Declaration of Conformity must be issued for each of these standards and kept on file as described in Annex II of the R&TTE Directive.

Furthermore, the manufacturer must maintain a copy of the modules' documentation and ensure the final product does not exceed the specified power ratings, antenna specifications, and/or installation requirements as specified in the user manual. If any of these specifications are exceeded in the final product, a submission must be made to a notified body for compliance testing to all required standards.



## Important

The 'CE' marking must be affixed to a visible location on the OEM product. The CE mark shall consist of the initials "CE" taking the following form:

The CE marking must have a height of at least 5mm except where this is not possible on account of the nature of the apparatus. The CE marking must be affixed visibly, legibly, and indelibly. More detailed information about CE marking requirements you can find at "DIRECTIVE 1999/5/EC OF THE EUROPEAN PARLIAMENT AND OF THE COUNCIL" on 9 March 1999 at section 12.

## 6.3 Canada (IC)

The ATREB233-XPRO Module complies with Industry Canada specifications RSS-210 and RSS – GenIC.

ID for ATREB233-XPRO is 11019A-091887

ATREB233-XPRO is limited modular approved and required separate approval for this module when used on an application board.

User manuals for licence-exempt radio apparatus shall contain the following or equivalent notice in a conspicuous location in the user manual or alternatively on the device or both.

This device complies with Industry Canada licence-exempt RSS standard(s). Operation is subject to the following two conditions:

- (1) this device may not cause interference, and
- (2) this device must accept any interference, including interference that may cause undesired operation of the device.

Le présent appareil est conforme aux CNR d'Industrie Canada applicables aux appareils radioexempts de licence. L'exploitation est autorisée aux deux conditions suivantes:

- (1) l'appareil ne doit pas produire de brouillage, et
- (2) l'utilisateur de l'appareil doit accepter tout brouillage radioélectrique subi, même si le brouillage est susceptible d'en compromettre le fonctionnement.

Under Industry Canada regulations, this radio transmitter may only operate using an antenna of a type and maximum (or lesser) gain approved for the transmitter by Industry Canada. To reduce potential radio interference to other users, the antenna type and its gain should be so chosen that the equivalent isotropically radiated power (e.i.r.p.) is not more than that necessary for successful communication

Conformément à la réglementation d'Industrie Canada, le présent émetteur radio peut fonctionner avec une antenne d'un type et d'un gain maximal (ou inférieur) approuvé pour l'émetteur par Industrie Canada. Dans le but de réduire les risques de brouillage radioélectrique à l'intention des autres utilisateurs, il faut choisir le type d'antenne et son gain de sorte que la puissance isotrope rayonnée équivalente (p.i.r.e.) ne dépasse pas l'intensité nécessaire à l'établissement d'une communication satisfaisante.

## 6.4 Using Limited Modular Certified Products

The ATREB233-XPRO Module is certified under part 15 of FCC rules. The Modular certification category of this module is "Limited Modular". The End product using these modules hence has to undergo compliance testing and receive a new FCC ID for the final product carrying these modules. Certification of the final product lies solely with the type of design of the final product.

---

**Warning**

The Original Equipment Manufacturer (OEM) must ensure that the OEM modular transmitter must be labeled with its own FCC ID number. This includes a clearly visible label on the outside of the final product enclosure that displays the contents shown below. If the FCC ID is not visible when the equipment is installed inside another device, then the outside of the device into which the equipment is installed must also display a label referring to the enclosed equipment.

---

**Important**

This equipment complies with Part 15 of the FCC Rules. Operation is subject to the following two conditions: (1) this device may not cause harmful interference, and (2) this device must accept any interference received, including interference that may cause undesired operation (FCC 15.19). The internal / external antenna(s) used for this mobile transmitter must provide a separation distance of at least 20cm from all persons and must not be co-located or operating in conjunction with any other antenna or transmitter. Installers must be provided with antenna installation instructions and transmitter operating conditions for satisfying RF exposure compliance. This device is approved as a mobile device with respect to RF exposure compliance, and may only be marketed to OEM installers. Use in portable exposure conditions (FCC 2.1093) requires separate equipment authorization.

---

**Important**

Modifications not expressly approved by this company could void the user's authority to operate this equipment (FCC section 15.21).

---

**Important**

This equipment has been tested and found to comply with the limits for a Class A digital device, pursuant to Part 15 of the FCC Rules. These limits are designed to provide reasonable protection against harmful interference when the equipment is operated in a commercial environment. This equipment generates, uses, and can radiate radio frequency energy and, if not installed and used in accordance with the instruction manual, may cause harmful interference to radio communications. Operation of this equipment in a residential area is likely to cause harmful interference in which case the user will be required to correct the interference at his own expense (FCC section 15.105).

---

## 7. Document revision history

Document revision	Date	Comment
42188A	10/2013	Initial document release



Enabling Unlimited Possibilities®

**Atmel Corporation** 1600 Technology Drive, San Jose, CA 95110 USA

**T:** (+1)(408) 441.0311

**F:** (+1)(408) 436.4200

| [www.atmel.com](http://www.atmel.com)

© 2013 Atmel Corporation. All rights reserved. / Rev.: 42188A-MCU-11/2013

Atmel®, Atmel logo and combinations thereof, Enabling Unlimited Possibilities®, ZigBit®, and others are registered trademarks or trademarks of Atmel Corporation or its subsidiaries. Other terms and product names may be trademarks of others.

Disclaimer: The information in this document is provided in connection with Atmel products. No license, express or implied, by estoppel or otherwise, to any intellectual property right is granted by this document or in connection with the sale of Atmel products. EXCEPT AS SET FORTH IN THE ATMEL TERMS AND CONDITIONS OF SALES LOCATED ON THE ATMEL WEBSITE, ATMEL ASSUMES NO LIABILITY WHATSOEVER AND DISCLAIMS ANY EXPRESS, IMPLIED OR STATUTORY WARRANTY RELATING TO ITS PRODUCTS INCLUDING, BUT NOT LIMITED TO, THE IMPLIED WARRANTY OF MERCHANTABILITY, FITNESS FOR A PARTICULAR PURPOSE, OR NON-INFRINGEMENT. IN NO EVENT SHALL ATMEL BE LIABLE FOR ANY DIRECT, INDIRECT, CONSEQUENTIAL, PUNITIVE, SPECIAL OR INCIDENTAL DAMAGES (INCLUDING, WITHOUT LIMITATION, DAMAGES FOR LOSS AND PROFITS, BUSINESS INTERRUPTION, OR LOSS OF INFORMATION) ARISING OUT OF THE USE OR INABILITY TO USE THIS DOCUMENT, EVEN IF ATMEL HAS BEEN ADVISED OF THE POSSIBILITY OF SUCH DAMAGES. Atmel makes no representations or warranties with respect to the accuracy or completeness of the contents of this document and reserves the right to make changes to specifications and products descriptions at any time without notice. Atmel does not make any commitment to update the information contained herein. Unless specifically provided otherwise, Atmel products are not suitable for, and shall not be used in, automotive applications. Atmel products are not intended, authorized, or warranted for use as components in applications intended to support or sustain life.