

MUN2111T1 Series

Preferred Devices

Bias Resistor Transistors

PNP Silicon Surface Mount Transistors with Monolithic Bias Resistor Network

This new series of digital transistors is designed to replace a single device and its external resistor bias network. The BRT (Bias Resistor Transistor) contains a single transistor with a monolithic bias network consisting of two resistors; a series base resistor and a base-emitter resistor. The BRT eliminates these individual components by integrating them into a single device. The use of a BRT can reduce both system cost and board space. The device is housed in the SC-59 package which is designed for low power surface mount applications.

- Simplifies Circuit Design
- Reduces Board Space
- Reduces Component Count
- Moisture Sensitivity Level: 1
- ESD Rating – Human Body Model: Class 1
– Machine Model: Class B
- The SC-59 package can be soldered using wave or reflow. The modified gull-winged leads absorb thermal stress during soldering eliminating the possibility of damage to the die.
- Available in 8 mm embossed tape and reel
Use the Device Number to order the 7 inch/3000 unit reel.

MAXIMUM RATINGS ($T_A = 25^\circ\text{C}$ unless otherwise noted)

| Rating | Symbol | Value | Unit |
|---------------------------|-----------|-------|------|
| Collector-Base Voltage | V_{CB0} | 50 | Vdc |
| Collector-Emitter Voltage | V_{CE0} | 50 | Vdc |
| Collector Current | I_C | 100 | mAdc |

THERMAL CHARACTERISTICS

| Characteristic | Symbol | Max | Unit |
|---|-----------------|--|------------------------------|
| Total Device Dissipation $T_A = 25^\circ\text{C}$ Derate above 25°C | P_D | 230 (Note 1) 338 (Note 2) 1.8 (Note 1) 2.7 (Note 2) | mW $^\circ\text{C/W}$ |
| Thermal Resistance – Junction-to-Ambient | $R_{\theta JA}$ | 540 (Note 1) 370 (Note 2) | $^\circ\text{C/W}$ |
| Thermal Resistance – Junction-to-Lead | $R_{\theta JL}$ | 264 (Note 1) 287 (Note 2) | $^\circ\text{C/W}$ |
| Junction and Storage Temperature Range | T_J, T_{stg} | -55 to +150 | $^\circ\text{C}$ |

1. FR-4 @ Minimum Pad
2. FR-4 @ 1.0 x 1.0 inch Pad



ON Semiconductor®

<http://onsemi.com>

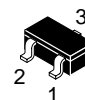
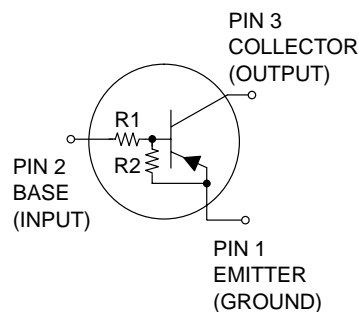

SC-59
CASE 318D
PLASTIC

MARKING DIAGRAM

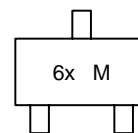

6x = Specific Device Code*
M = Date Code

ORDERING INFORMATION

See detailed ordering and shipping information on page 2 of this data sheet.

DEVICE MARKING INFORMATION

*See device marking table on page 2 of this data sheet.

Preferred devices are recommended choices for future use and best overall value.

MUN211T1 Series

DEVICE MARKING AND RESISTOR VALUES

| Device | Package | Marking | R1 (K) | R2 (K) | Shipping |
|--------------------|---------|---------|--------|--------|------------------|
| MUN2111T1 | SC-59 | 6A | 10 | 10 | 3000/Tape & Reel |
| MUN2112T1 | SC-59 | 6B | 22 | 22 | 3000/Tape & Reel |
| MUN2113T1 | SC-59 | 6C | 47 | 47 | 3000/Tape & Reel |
| MUN2114T1 | SC-59 | 6D | 10 | 47 | 3000/Tape & Reel |
| MUN2115T1 (Note 3) | SC-59 | 6E | 10 | ∞ | 3000/Tape & Reel |
| MUN2116T1 (Note 3) | SC-59 | 6F | 4.7 | ∞ | 3000/Tape & Reel |
| MUN2130T1 (Note 3) | SC-59 | 6G | 1.0 | 1.0 | 3000/Tape & Reel |
| MUN2131T1 (Note 3) | SC-59 | 6H | 2.2 | 2.2 | 3000/Tape & Reel |
| MUN2132T1 (Note 3) | SC-59 | 6J | 4.7 | 4.7 | 3000/Tape & Reel |
| MUN2133T1 (Note 3) | SC-59 | 6K | 4.7 | 47 | 3000/Tape & Reel |
| MUN2134T1 (Note 3) | SC-59 | 6L | 22 | 47 | 3000/Tape & Reel |
| MUN2136T1 | SC-59 | 6N | 100 | 100 | 3000/Tape & Reel |
| MUN2137T1 | SC-59 | 6P | 47 | 22 | 3000/Tape & Reel |
| MUN2140T1 (Note 3) | SC-59 | 6T | 47 | ∞ | 3000/Tape & Reel |

ELECTRICAL CHARACTERISTICS (T_A = 25°C unless otherwise noted)

| Characteristic | Symbol | Min | Typ | Max | Unit |
|----------------|--------|-----|-----|-----|------|
|----------------|--------|-----|-----|-----|------|

OFF CHARACTERISTICS

| | | | | | |
|---|----------------------|----|---|------|------|
| Collector-Base Cutoff Current (V _{CB} = 50 V, I _E = 0) | I _{CBO} | - | - | 100 | nAdc |
| Collector-Emitter Cutoff Current (V _{CE} = 50 V, I _B = 0) | I _{CEO} | - | - | 500 | nAdc |
| Emitter-Base Cutoff Current (V _{EB} = 6.0 V, I _C = 0) | I _{EBO} | - | - | 0.5 | mAdc |
| | MUN2111T1 | - | - | 0.2 | |
| | MUN2112T1 | - | - | 0.1 | |
| | MUN2113T1 | - | - | 0.2 | |
| | MUN2114T1 | - | - | 0.9 | |
| | MUN2115T1 | - | - | 1.9 | |
| | MUN2116T1 | - | - | 4.3 | |
| | MUN2130T1 | - | - | 2.3 | |
| | MUN2131T1 | - | - | 1.5 | |
| | MUN2132T1 | - | - | 0.18 | |
| | MUN2133T1 | - | - | 0.13 | |
| | MUN2134T1 | - | - | 0.05 | |
| | MUN2136T1 | - | - | 0.13 | |
| | MUN2137T1 | - | - | 0.20 | |
| | MUN2140T1 | - | - | | |
| Collector-Base Breakdown Voltage (I _C = 10 μA, I _E = 0) | V _{(BR)CBO} | 50 | - | - | Vdc |
| Collector-Emitter Breakdown Voltage (Note 4) (I _C = 2.0 mA, I _B = 0) | V _{(BR)CEO} | 50 | - | - | Vdc |

3. New resistor combinations. Updated curves to follow in subsequent data sheets.

4. Pulse Test: Pulse Width < 300 μs, Duty Cycle < 2.0%

MUN211T1 Series

ELECTRICAL CHARACTERISTICS (T_A = 25°C unless otherwise noted) (Continued)

| Characteristic | | Symbol | Min | Typ | Max | Unit | |
|---|--|----------------------|-----------|-----|------|------|------|
| ON CHARACTERISTICS (Note 5) | | | | | | | |
| DC Current Gain (V _{CE} = 10 V, I _C = 5.0 mA) | MUN2111T1 | h _{FE} | 35 | 60 | – | | |
| | MUN2112T1 | | 60 | 100 | – | | |
| | MUN2113T1 | | 80 | 140 | – | | |
| | MUN2114T1 | | 80 | 140 | – | | |
| | MUN2115T1 | | 160 | 250 | – | | |
| | MUN2116T1 | | 160 | 250 | – | | |
| | MUN2130T1 | | 3.0 | 5.0 | – | | |
| | MUN2131T1 | | 8.0 | 15 | – | | |
| | MUN2132T1 | | 15 | 27 | – | | |
| | MUN2133T1 | | 80 | 140 | – | | |
| | MUN2134T1 | | 80 | 130 | – | | |
| | MUN2136T1 | | 80 | 150 | – | | |
| | MUN2137T1 | | 80 | 140 | – | | |
| MUN2140T1 | 120 | 250 | – | | | | |
| Collector–Emitter Saturation Voltage (I _C = 10 mA, I _B = 0.3 mA) | MUN2111T1 | V _{CE(sat)} | – | – | 0.25 | Vdc | |
| | MUN2112T1 | | – | – | 0.25 | | |
| | MUN2113T1 | | – | – | 0.25 | | |
| | MUN2114T1 | | – | – | 0.25 | | |
| | MUN2115T1 | | – | – | 0.25 | | |
| | MUN2130T1 | | – | – | 0.25 | | |
| | MUN2136T1 | | – | – | 0.25 | | |
| | MUN2137T1 | | – | – | 0.25 | | |
| | (I _C = 10 mA, I _B = 5.0 mA) | | MUN2131T1 | – | – | | 0.25 |
| | (I _C = 10 mA, I _B = 1.0 mA) | | MUN2116T1 | – | – | | 0.25 |
| | MUN2132T1 | | – | – | 0.25 | | |
| | MUN2134T1 | | – | – | 0.25 | | |
| | MUN2140T1 | | – | – | 0.25 | | |
| Output Voltage (on) (V _{CC} = 5.0 V, V _B = 2.5 V, R _L = 1.0 kΩ) | MUN2111T1 | V _{OL} | – | – | 0.2 | Vdc | |
| | MUN2112T1 | | – | – | 0.2 | | |
| | MUN2114T1 | | – | – | 0.2 | | |
| | MUN2115T1 | | – | – | 0.2 | | |
| | MUN2116T1 | | – | – | 0.2 | | |
| | MUN2130T1 | | – | – | 0.2 | | |
| | MUN2131T1 | | – | – | 0.2 | | |
| | MUN2132T1 | | – | – | 0.2 | | |
| | MUN2133T1 | | – | – | 0.2 | | |
| | MUN2134T1 | | – | – | 0.2 | | |
| | (V _{CC} = 5.0 V, V _B = 3.5 V, R _L = 1.0 kΩ) | | MUN2113T1 | – | – | | 0.2 |
| | MUN2140T1 | | – | – | 0.2 | | |
| | (V _{CC} = 5.0 V, V _B = 5.5 V, R _L = 1.0 kΩ) | | MUN2136T1 | – | – | | 0.2 |
| (V _{CC} = 5.0 V, V _B = 4.0 V, R _L = 1.0 kΩ) | MUN2137T1 | – | – | 0.2 | | | |

5. Pulse Test: Pulse Width < 300 μs, Duty Cycle < 2.0%

MUN211T1 Series

ELECTRICAL CHARACTERISTICS ($T_A = 25^\circ\text{C}$ unless otherwise noted) (Continued)

| Characteristic | Symbol | Min | Typ | Max | Unit | |
|---|---|-----------|--|--|--|------------|
| ON CHARACTERISTICS (Note 6) (Continued) | | | | | | |
| Output Voltage (off) ($V_{CC} = 5.0\text{ V}$, $V_B = 0.5\text{ V}$, $R_L = 1.0\text{ k}\Omega$) ($V_{CC} = 5.0\text{ V}$, $V_B = 0.050\text{ V}$, $R_L = 1.0\text{ k}\Omega$) ($V_{CC} = 5.0\text{ V}$, $V_B = 0.25\text{ V}$, $R_L = 1.0\text{ k}\Omega$) | V_{OH} | 4.9 | – | – | Vdc | |
| Input Resistor | MUN2111T1 MUN2112T1 MUN2113T1 MUN2114T1 MUN2115T1 MUN2116T1 MUN2130T1 MUN2131T1 MUN2132T1 MUN2140T1 | R1 | 7.0 15.4 32.9 7.0 7.0 3.3 0.7 1.5 3.3 3.3 15.4 70 32.9 32.9 | 10 22 47 10 10 4.7 1.0 2.2 4.7 4.7 22 100 47 47 | 13 28.6 61.1 13 13 6.1 1.3 2.9 6.1 6.1 28.6 130 61.1 61.1 | k Ω |
| Resistor Ratio | MUN2111T1/MUN2112T1/MUN2113T1/ MUN2136T1 MUN2114T1 MUN2115T1/MUN2116T1/MUN2140T1 MUN2130T1/MUN2131T1/MUN2132T1 MUN2133T1 MUN2134T1 MUN2137T1 | R_1/R_2 | 0.8 0.17 – 0.8 0.055 0.38 1.7 | 1.0 0.21 – 1.0 0.1 0.47 2.1 | 1.2 0.25 – 1.2 0.185 0.56 2.6 | |

6. Pulse Test: Pulse Width < 300 μs , Duty Cycle < 2.0%

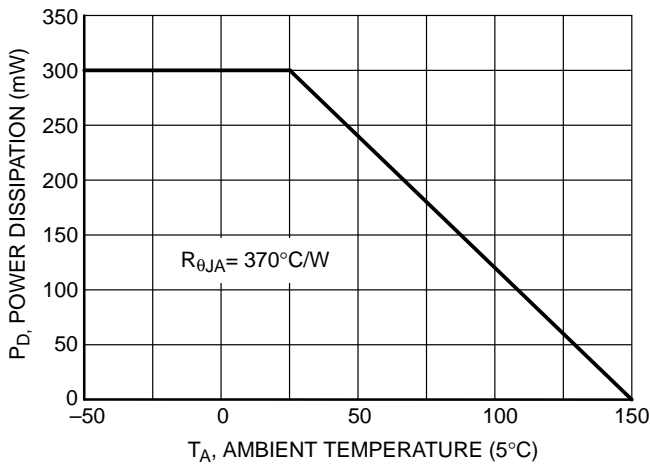

Figure 1. Derating Curve

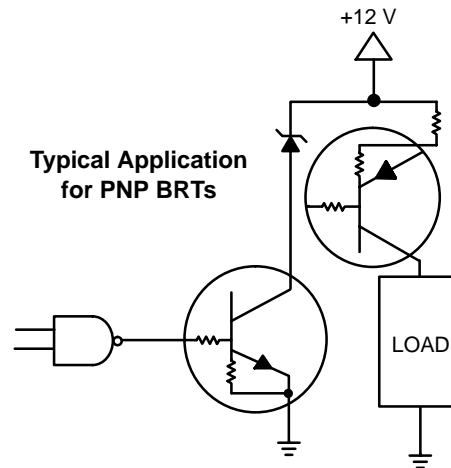

Figure 2. Inexpensive, Unregulated Current Source

MUN211T1 Series

TYPICAL ELECTRICAL CHARACTERISTICS – MUN211T1

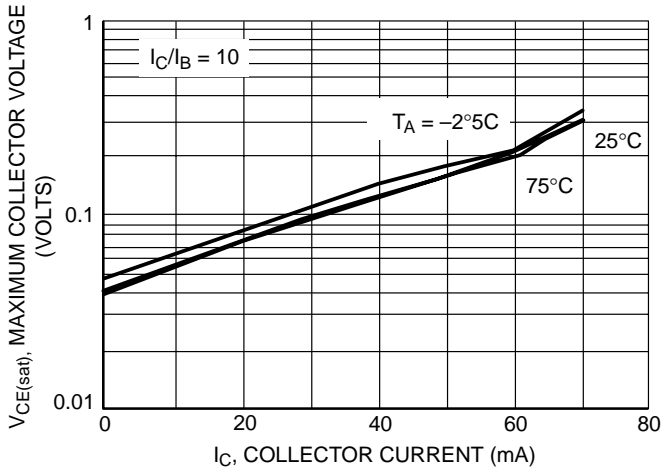

Figure 3. $V_{CE(sat)}$ vs. I_C

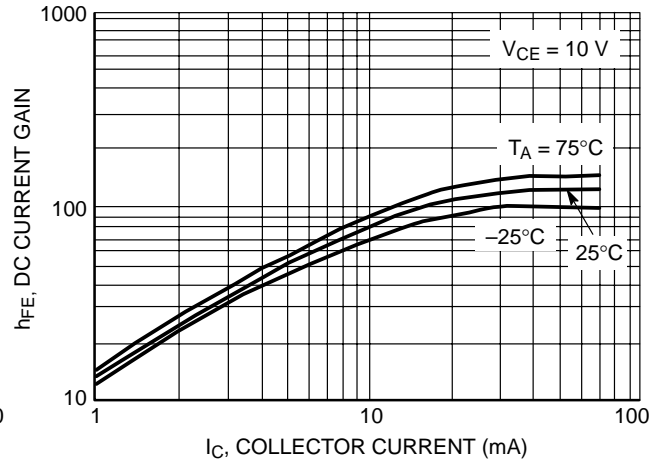

Figure 4. DC Current Gain

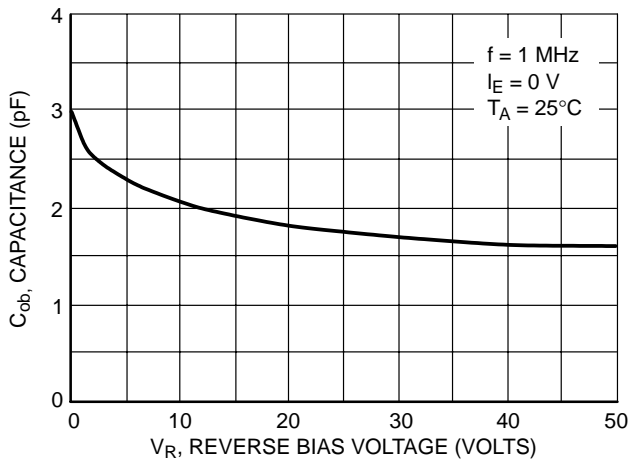

Figure 5. Output Capacitance

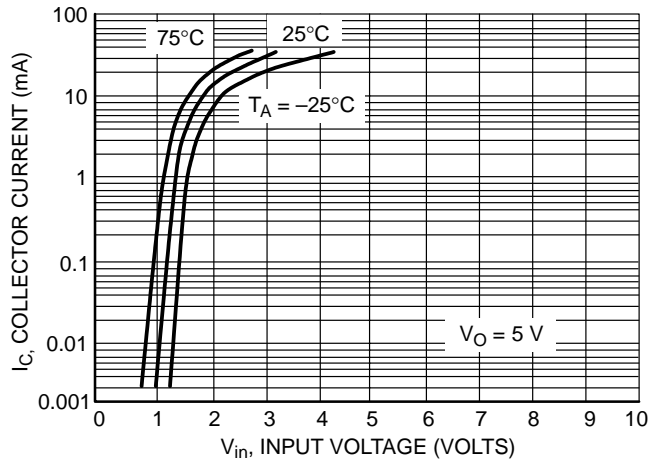

Figure 6. Output Current vs. Input Voltage

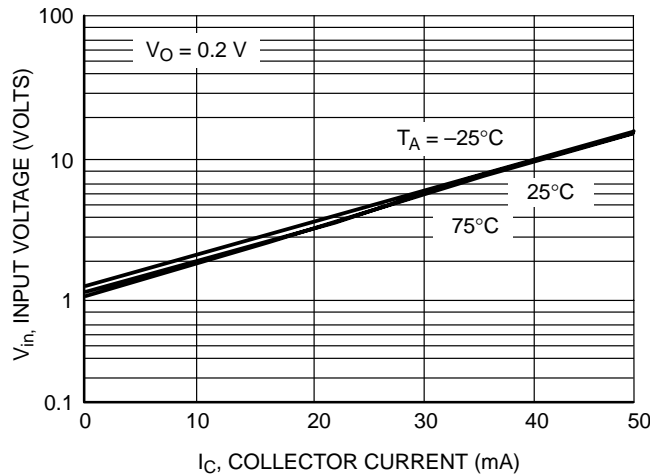

Figure 7. Input Voltage vs. Output Current

MUN211T1 Series

TYPICAL ELECTRICAL CHARACTERISTICS – MUN2112T1

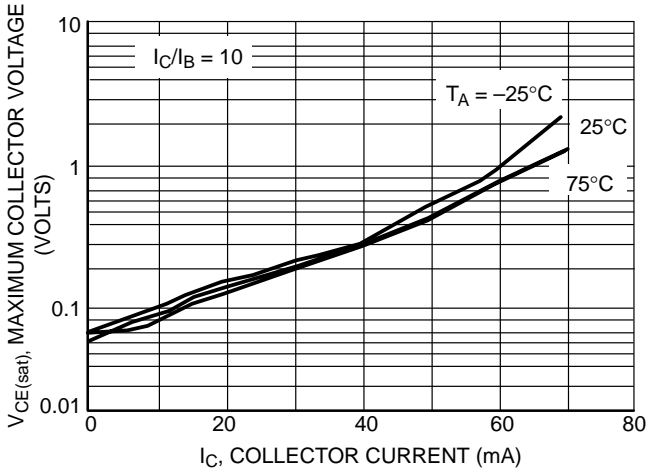

Figure 8. $V_{CE(sat)}$ vs. I_C

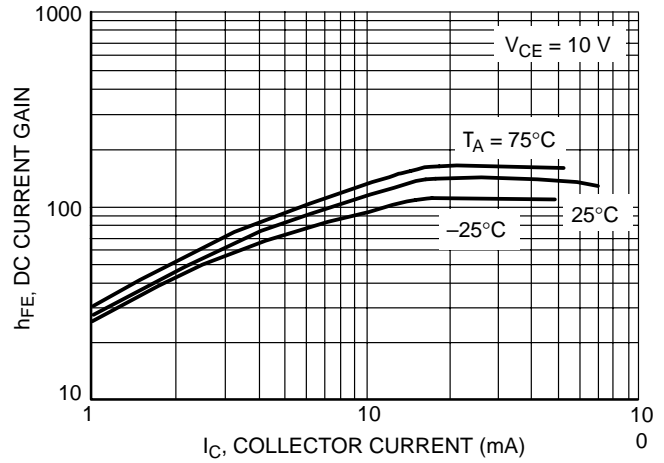

Figure 9. DC Current Gain

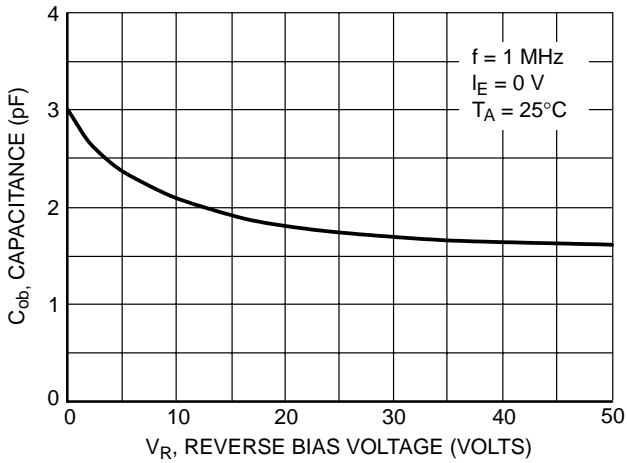

Figure 10. Output Capacitance

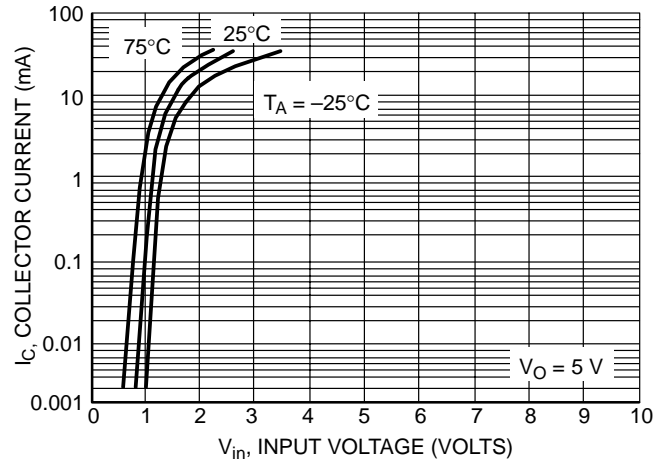

Figure 11. Output Current vs. Input Voltage

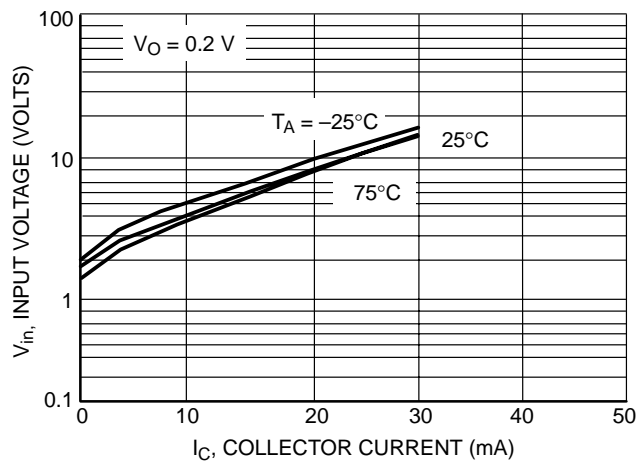

Figure 12. Input Voltage vs. Output Current

MUN2111T1 Series

TYPICAL ELECTRICAL CHARACTERISTICS – MUN2113T1

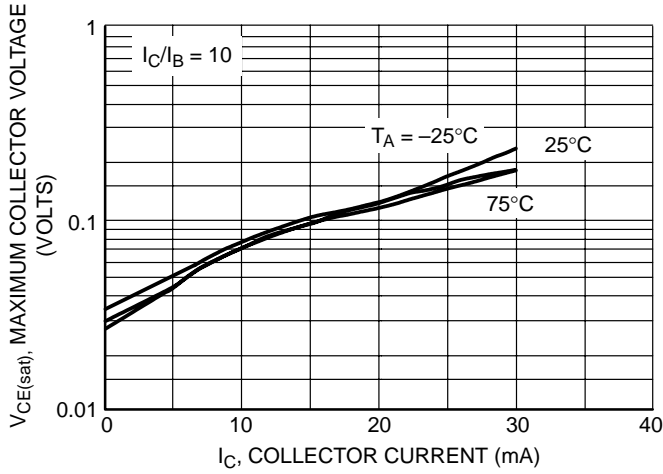

Figure 13. $V_{CE(sat)}$ vs. I_C

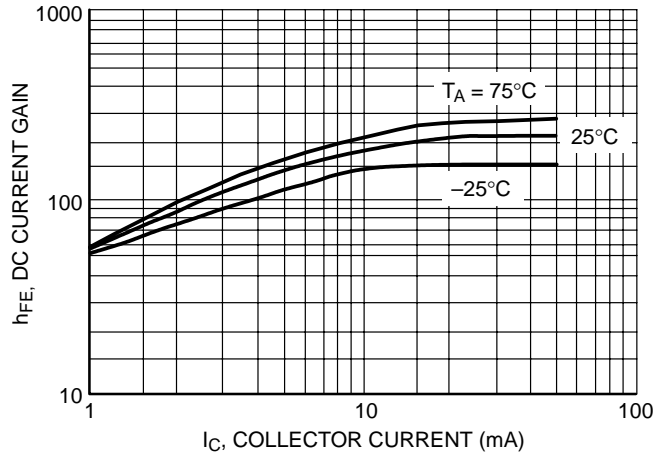

Figure 14. DC Current Gain

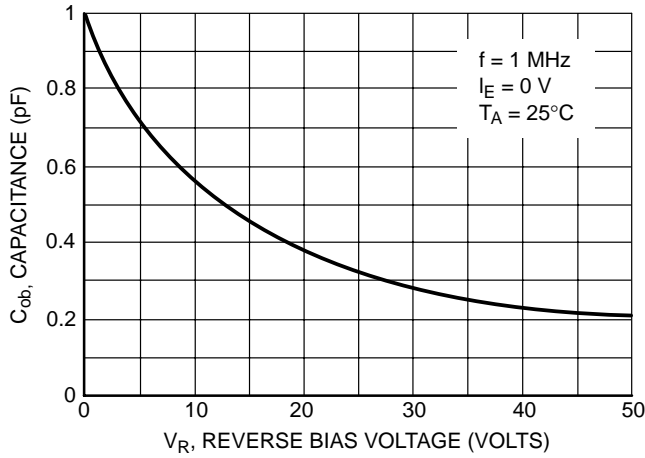

Figure 15. Output Capacitance

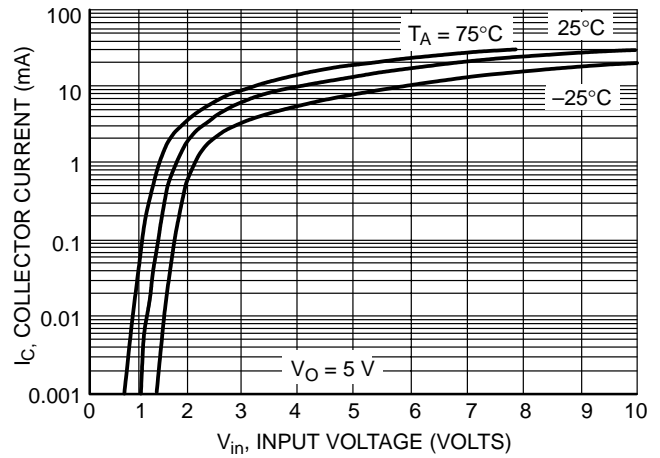

Figure 16. Output Current vs. Input Voltage

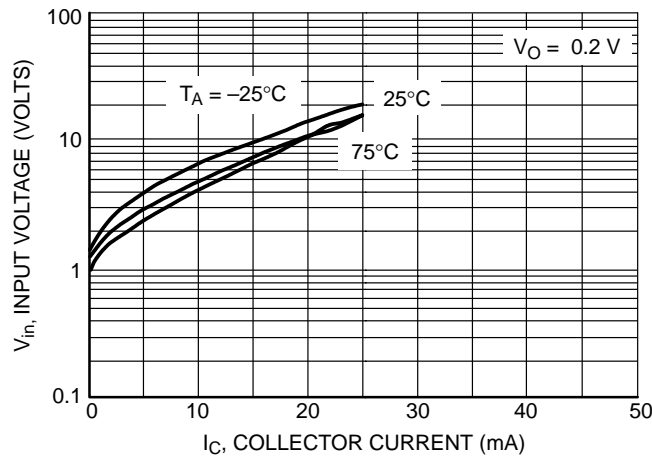

Figure 17. Input Voltage vs. Output Current

MUN211T1 Series

TYPICAL ELECTRICAL CHARACTERISTICS – MUN2114T1

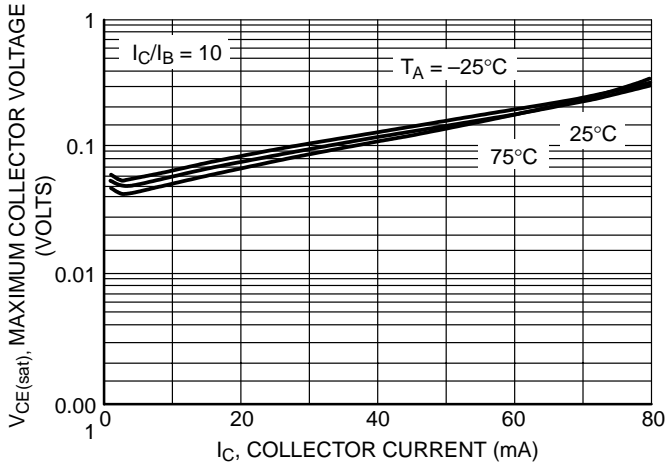

Figure 18. $V_{CE(sat)}$ vs. I_C

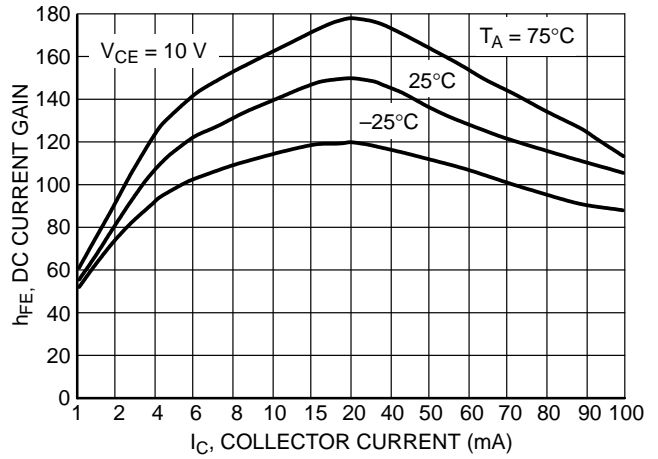

Figure 19. DC Current Gain

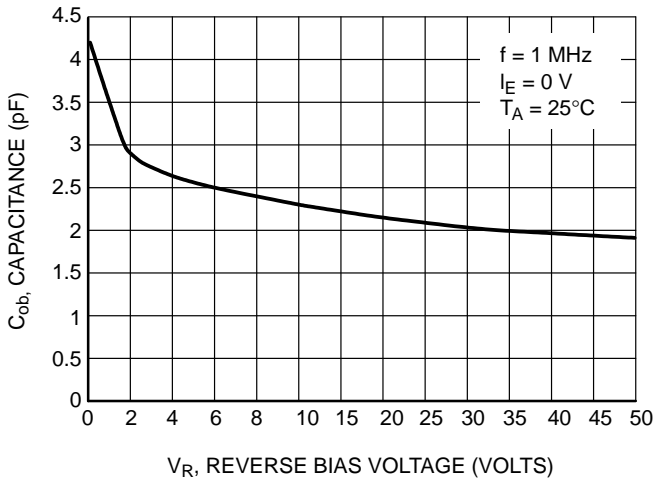

Figure 20. Output Capacitance

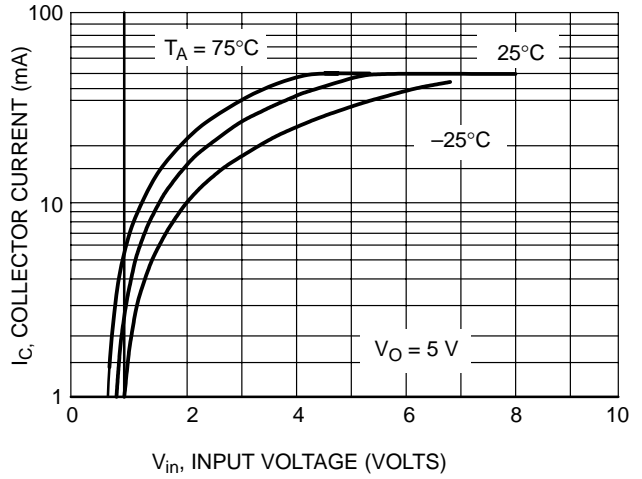

Figure 21. Output Current vs. Input Voltage

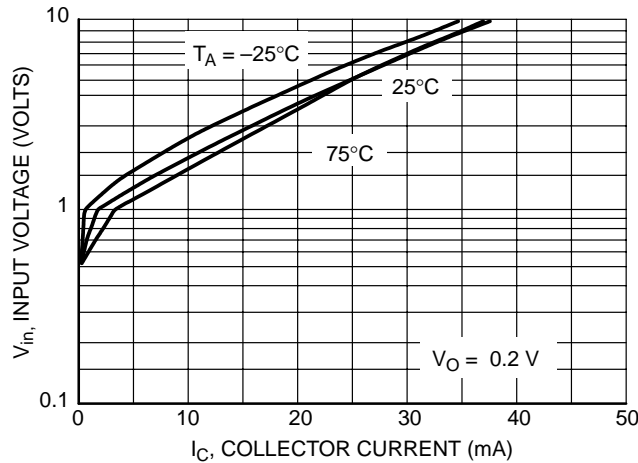

Figure 22. Input Voltage vs. Output Current

MUN211T1 Series

TYPICAL ELECTRICAL CHARACTERISTICS – MUN2131T1

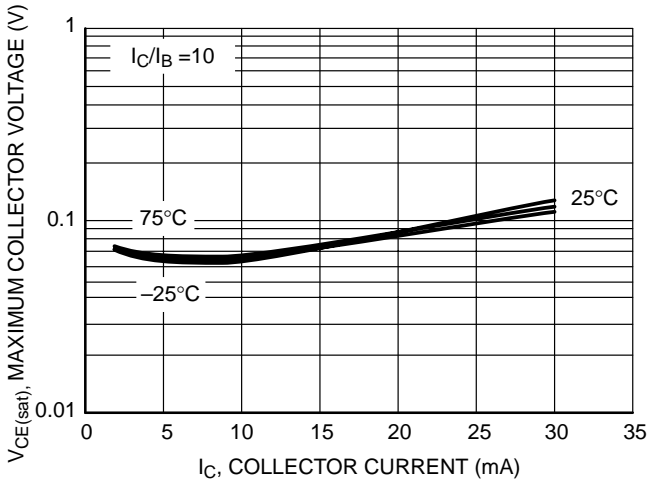

Figure 23. $V_{CE(sat)}$ vs. I_C

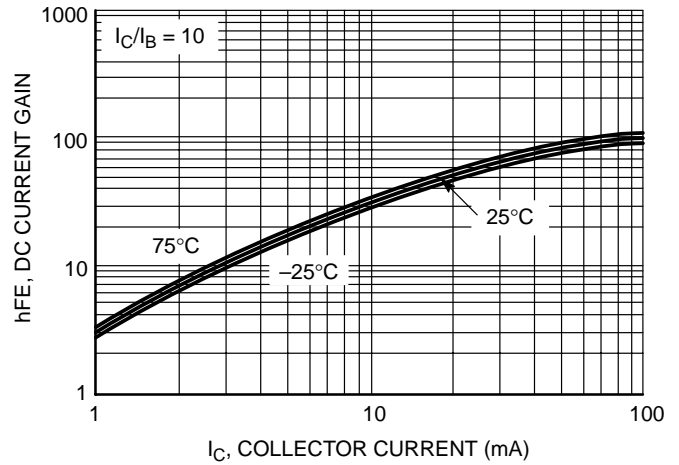

Figure 24. DC Current Gain

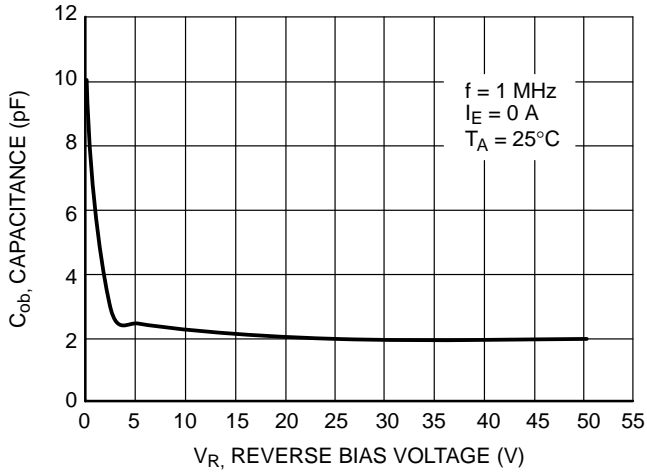

Figure 25. Output Capacitance

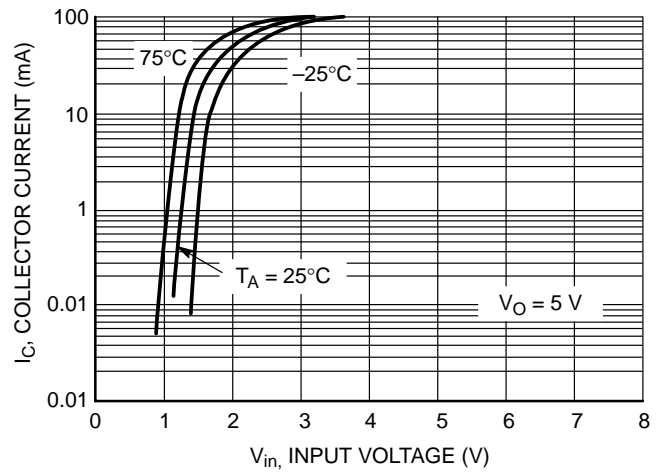

Figure 26. Output Current vs. Input Voltage

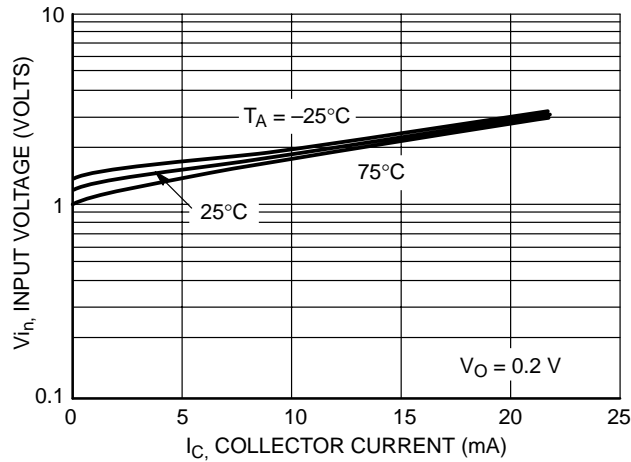

Figure 27. Input Voltage vs. Output Current

MUN211T1 Series

TYPICAL ELECTRICAL CHARACTERISTICS — MUN2136T1

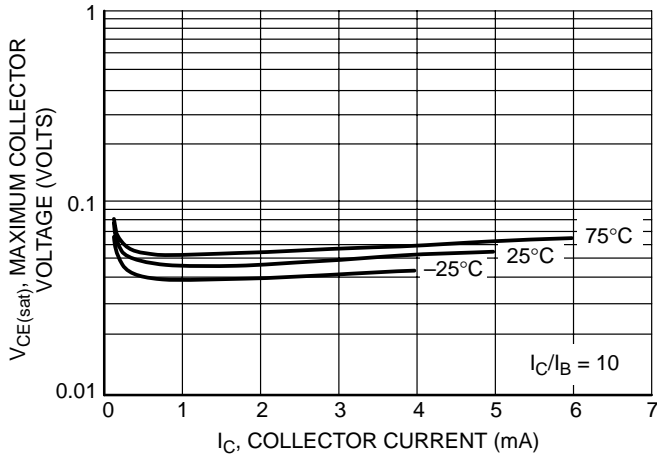

Figure 28. Maximum Collector Voltage versus Collector Current

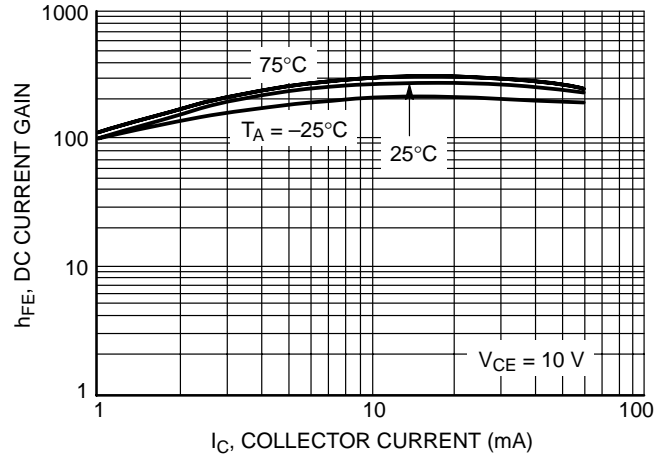

Figure 29. DC Current Gain

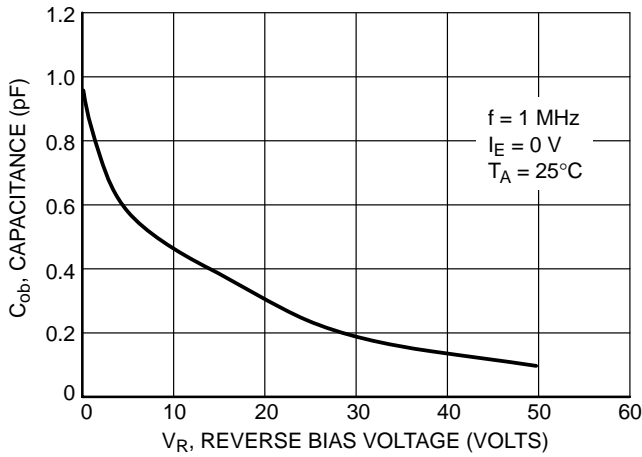

Figure 30. Output Capacitance

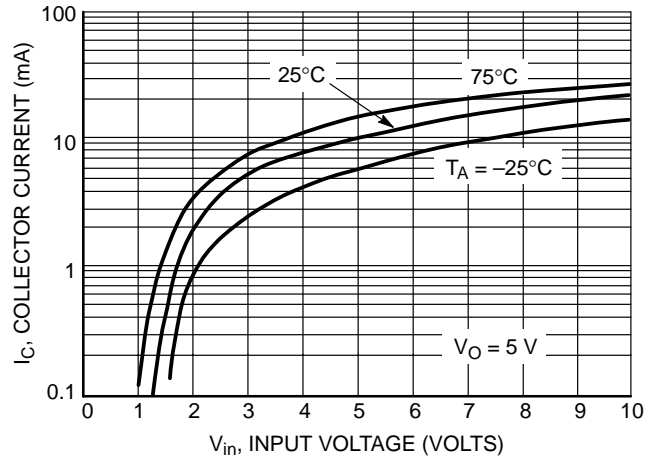

Figure 31. Output Current versus Input Voltage

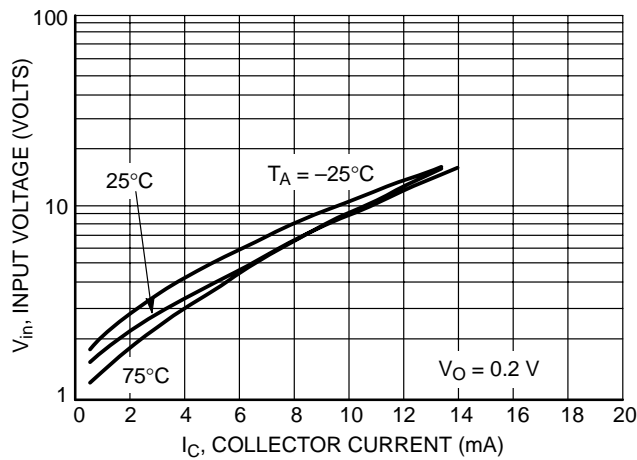

Figure 32. Input Voltage versus Output Current

MUN2111T1 Series

TYPICAL ELECTRICAL CHARACTERISTICS — MUN2137T1

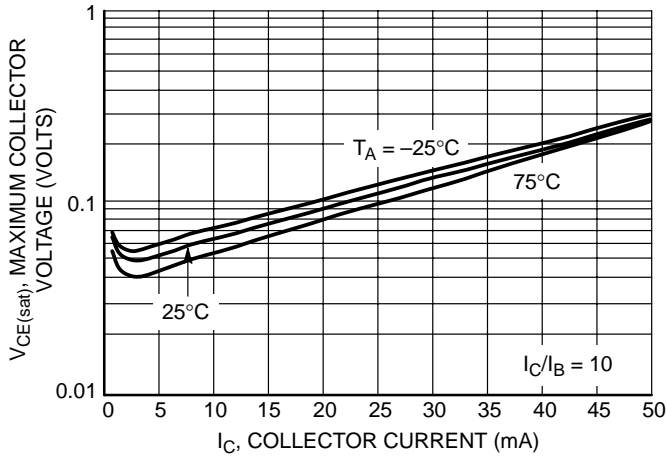

Figure 33. Maximum Collector Voltage versus Collector Current

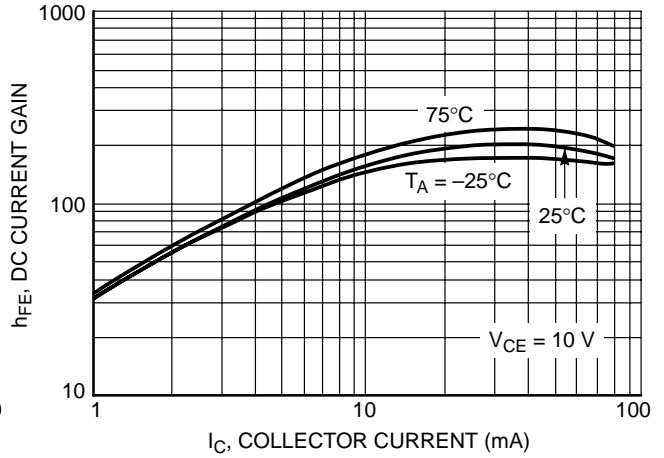

Figure 34. DC Current Gain

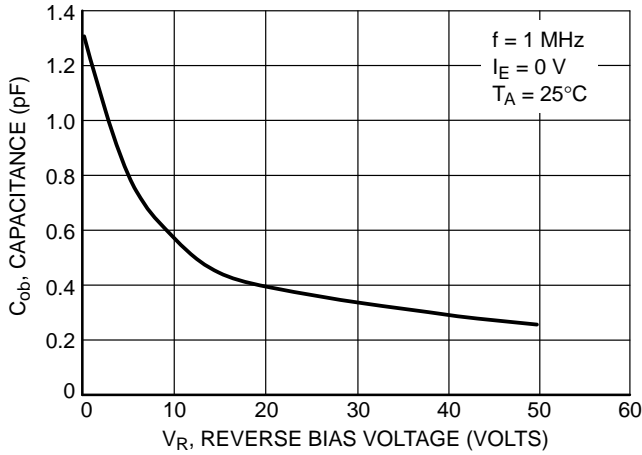

Figure 35. Output Capacitance

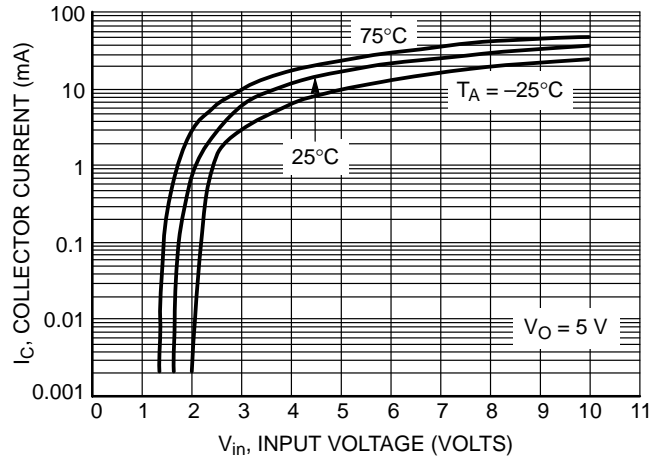

Figure 36. Output Current versus Input Voltage

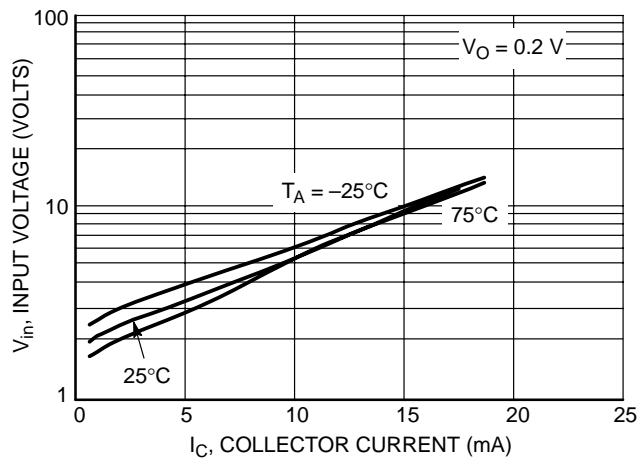

Figure 37. Input Voltage versus Output Current

MUN211T1 Series

INFORMATION FOR USING THE SC-59 SURFACE MOUNT PACKAGE

MINIMUM RECOMMENDED FOOTPRINT FOR SURFACE MOUNTED APPLICATIONS

Surface mount board layout is a critical portion of the total design. The footprint for the semiconductor packages must be the correct size to insure proper solder connection

interface between the board and the package. With the correct pad geometry, the packages will self align when subjected to a solder reflow process.

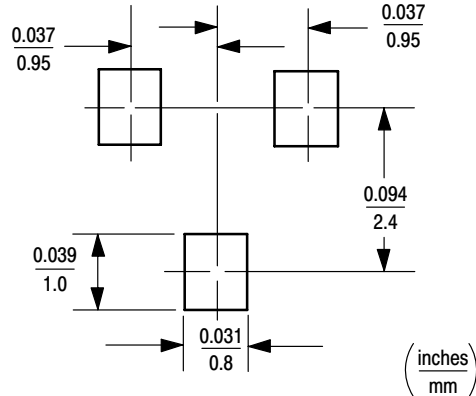

SC-59 POWER DISSIPATION

The power dissipation of the SC-59 is a function of the pad size. This can vary from the minimum pad size for soldering to the pad size given for maximum power dissipation. Power dissipation for a surface mount device is determined by $T_{J(max)}$, the maximum rated junction temperature of the die, $R_{\theta JA}$, the thermal resistance from the device junction to ambient; and the operating temperature, T_A . Using the values provided on the data sheet, P_D can be calculated as follows.

$$P_D = \frac{T_{J(max)} - T_A}{R_{\theta JA}}$$

The values for the equation are found in the maximum ratings table on the data sheet. Substituting these values into

the equation for an ambient temperature T_A of 25°C, one can calculate the power dissipation of the device which in this case is 338 milliwatts.

$$P_D = \frac{150^\circ\text{C} - 25^\circ\text{C}}{370^\circ\text{C/W}} = 338 \text{ milliwatts}$$

The 370°C/W assumes the use of the recommended footprint on a glass epoxy printed circuit board to achieve a power dissipation of 338 milliwatts. Another alternative would be to use a ceramic substrate or an aluminum core board such as Thermal Clad™. Using a board material such as Thermal Clad, the power dissipation can be doubled using the same footprint.

SOLDERING PRECAUTIONS

The melting temperature of solder is higher than the rated temperature of the device. When the entire device is heated to a high temperature, failure to complete soldering within a short time could result in device failure. Therefore, the following items should always be observed in order to minimize the thermal stress to which the devices are subjected.

- Always preheat the device.
- The delta temperature between the preheat and soldering should be 100°C or less.*
- When preheating and soldering, the temperature of the leads and the case must not exceed the maximum temperature ratings as shown on the data sheet. When using infrared heating with the reflow soldering method, the difference should be a maximum of 10°C.

- The soldering temperature and time should not exceed 260°C for more than 10 seconds.
- When shifting from preheating to soldering, the maximum temperature gradient should be 5°C or less.
- After soldering has been completed, the device should be allowed to cool naturally for at least three minutes. Gradual cooling should be used as the use of forced cooling will increase the temperature gradient and result in latent failure due to mechanical stress.
- Mechanical stress or shock should not be applied during cooling

* Soldering a device without preheating can cause excessive thermal shock and stress which can result in damage to the device.

MUN2111T1 Series

SOLDER STENCIL GUIDELINES

Prior to placing surface mount components onto a printed circuit board, solder paste must be applied to the pads. A solder stencil is required to screen the optimum amount of solder paste onto the footprint. The stencil is made of brass or stainless steel with a typical thickness of 0.008 inches.

The stencil opening size for the surface mounted package should be the same as the pad size on the printed circuit board, i.e., a 1:1 registration.

TYPICAL SOLDER HEATING PROFILE

For any given circuit board, there will be a group of control settings that will give the desired heat pattern. The operator must set temperatures for several heating zones, and a figure for belt speed. Taken together, these control settings make up a heating “profile” for that particular circuit board. On machines controlled by a computer, the computer remembers these profiles from one operating session to the next. Figure 7 shows a typical heating profile for use when soldering a surface mount device to a printed circuit board. This profile will vary among soldering systems but it is a good starting point. Factors that can affect the profile include the type of soldering system in use, density and types of components on the board, type of solder used, and the type of board or substrate material being used. This profile shows temperature versus time.

The line on the graph shows the actual temperature that might be experienced on the surface of a test board at or near a central solder joint. The two profiles are based on a high density and a low density board. The Vitronics SMD310 convection/infrared reflow soldering system was used to generate this profile. The type of solder used was 62/36/2 Tin Lead Silver with a melting point between 177–189°C. When this type of furnace is used for solder reflow work, the circuit boards and solder joints tend to heat first. The components on the board are then heated by conduction. The circuit board, because it has a large surface area, absorbs the thermal energy more efficiently, then distributes this energy to the components. Because of this effect, the main body of a component may be up to 30 degrees cooler than the adjacent solder joints.

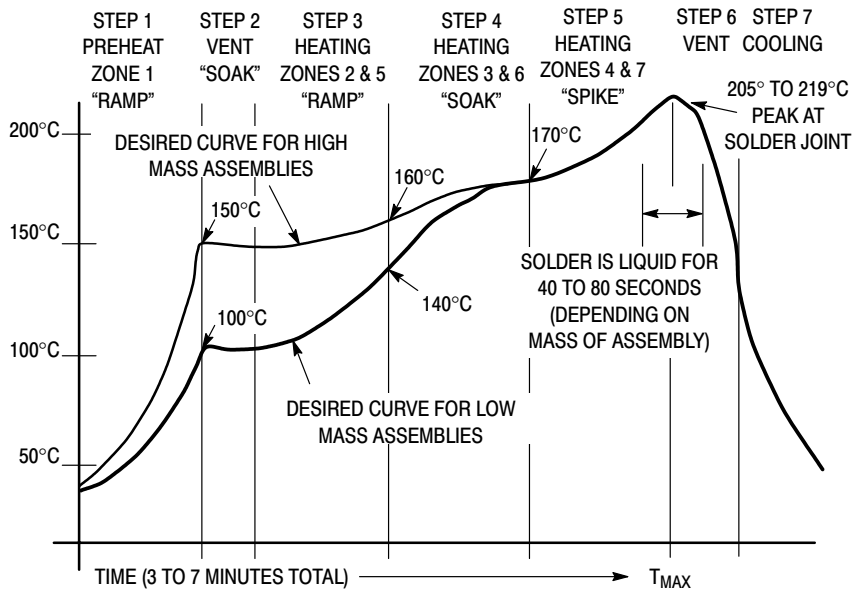
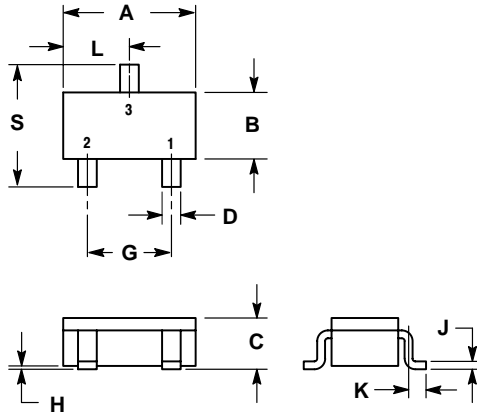

Figure 38. Typical Solder Heating Profile

MUN2111T1 Series

PACKAGE DIMENSIONS

SC-59
CASE 318D-04
ISSUE F



NOTES:

1. DIMENSIONING AND TOLERANCING PER ANSI Y14.5M, 1982.
2. CONTROLLING DIMENSION: MILLIMETER.

| DIM | MILLIMETERS | | INCHES | |
|-----|-------------|-------|--------|--------|
| | MIN | MAX | MIN | MAX |
| A | 2.70 | 3.10 | 0.1063 | 0.1220 |
| B | 1.30 | 1.70 | 0.0512 | 0.0669 |
| C | 1.00 | 1.30 | 0.0394 | 0.0511 |
| D | 0.35 | 0.50 | 0.0138 | 0.0196 |
| G | 1.70 | 2.10 | 0.0670 | 0.0826 |
| H | 0.013 | 0.100 | 0.0005 | 0.0040 |
| J | 0.09 | 0.18 | 0.0034 | 0.0070 |
| K | 0.20 | 0.60 | 0.0079 | 0.0236 |
| L | 1.25 | 1.65 | 0.0493 | 0.0649 |
| S | 2.50 | 3.00 | 0.0985 | 0.1181 |

STYLE 1:

- PIN 1. EMITTER
- BASE
- COLLECTOR

Notes

MUN2111T1 Series

Thermal Clad is a trademark of the Bergquist Company.

ON Semiconductor and  are trademarks of Semiconductor Components Industries, LLC (SCILLC). SCILLC reserves the right to make changes without further notice to any products herein. SCILLC makes no warranty, representation or guarantee regarding the suitability of its products for any particular purpose, nor does SCILLC assume any liability arising out of the application or use of any product or circuit, and specifically disclaims any and all liability, including without limitation special, consequential or incidental damages. "Typical" parameters which may be provided in SCILLC data sheets and/or specifications can and do vary in different applications and actual performance may vary over time. All operating parameters, including "Typicals" must be validated for each customer application by customer's technical experts. SCILLC does not convey any license under its patent rights nor the rights of others. SCILLC products are not designed, intended, or authorized for use as components in systems intended for surgical implant into the body, or other applications intended to support or sustain life, or for any other application in which the failure of the SCILLC product could create a situation where personal injury or death may occur. Should Buyer purchase or use SCILLC products for any such unintended or unauthorized application, Buyer shall indemnify and hold SCILLC and its officers, employees, subsidiaries, affiliates, and distributors harmless against all claims, costs, damages, and expenses, and reasonable attorney fees arising out of, directly or indirectly, any claim of personal injury or death associated with such unintended or unauthorized use, even if such claim alleges that SCILLC was negligent regarding the design or manufacture of the part. SCILLC is an Equal Opportunity/Affirmative Action Employer.

PUBLICATION ORDERING INFORMATION

Literature Fulfillment:

Literature Distribution Center for ON Semiconductor
P.O. Box 5163, Denver, Colorado 80217 USA
Phone: 303-675-2175 or 800-344-3860 Toll Free USA/Canada
Fax: 303-675-2176 or 800-344-3867 Toll Free USA/Canada
Email: ONlit@hibbertco.com

N. American Technical Support: 800-282-9855 Toll Free USA/Canada

JAPAN: ON Semiconductor, Japan Customer Focus Center
4-32-1 Nishi-Gotanda, Shinagawa-ku, Tokyo, Japan 141-0031
Phone: 81-3-5740-2700
Email: r14525@onsemi.com

ON Semiconductor Website: <http://onsemi.com>

For additional information, please contact your local Sales Representative.