

Extrusion

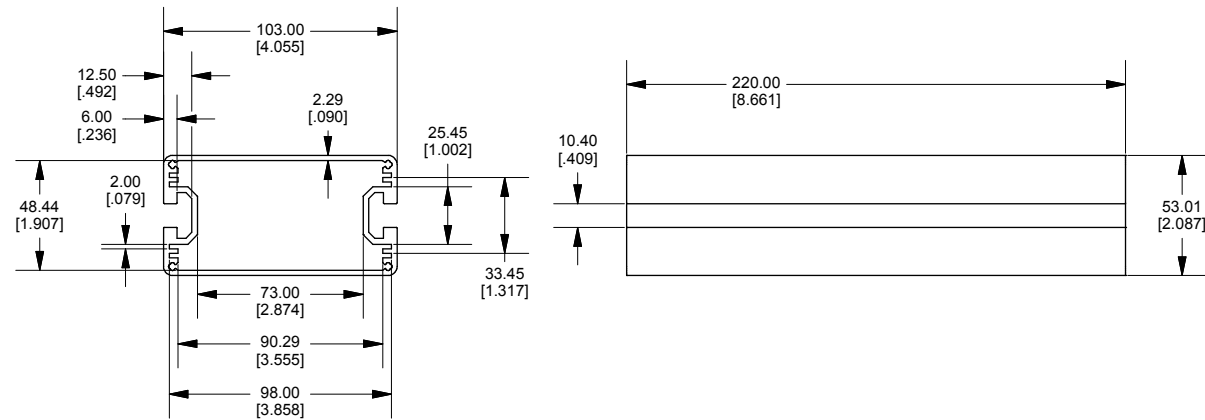

End Plate

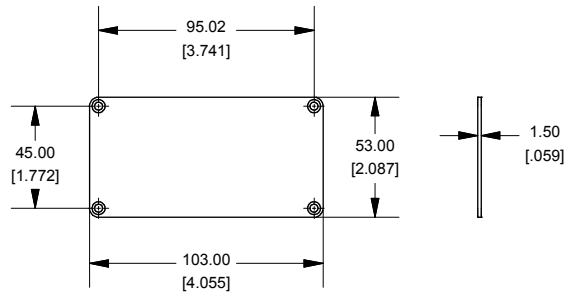

Open Bezel

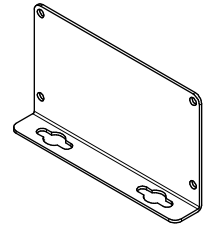
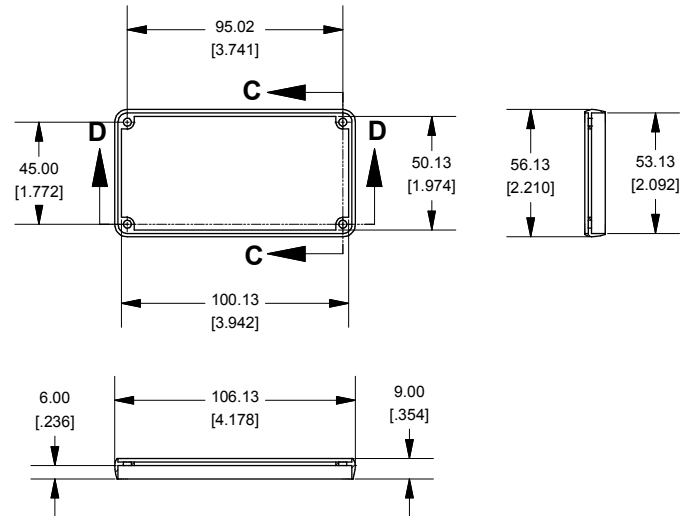

OPTIONAL FLANGE END PANELS 1455NF

Enclosures can be Factory Modified (Milling, Drilling, Printing etc.)
 Solid models of this enclosure available in STEP or IGES.
 Contact Factory mjm@hammondmg.com

NOTE	
Purchased assembly includes extrusion, plastic bezels, end panels, #6 Taptight screws and self adhesive rubber feet.	
Box made from Extruded Aluminum 6063.	
Bezels made from polycarbonate.	

1455NC2201	
PART NUMBERS	
Clear Anodized	1455NC2201
ACCESSORIES	
T Bolt (M8 x 20)	1455TBOLT
T Nut (M8)	1455TNUT
T Spring Nut (M8)	1455TSNUT

