

# G230-27

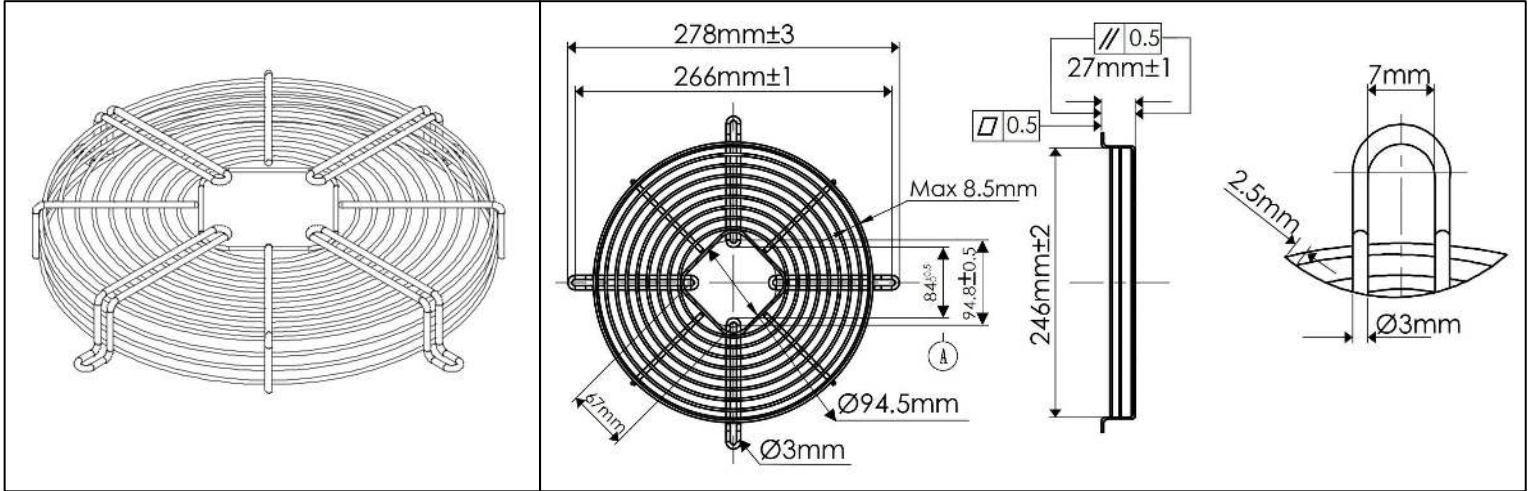

## Impeller Grille for OAM Open Frame Motor Series



Material	Steel, Black Finish
Mount Hole Spacing	246~266mm
Height	27mm±1
Max Fastener Diameter	7mm
Grid Wire Spacing	≤ 8.5mm