

LF SERIES CLASS CC/CD AND MIDGET (10x38 mm) FUSE BLOCKS

600 V



Description

The Littelfuse Class CC, CD and midget blocks offer generous space savings and enhanced value. DIN-rail mounting and universal mounting holes are available as well as an indication feature on all Class CD fuse blocks.

Features/Benefits

- Space-saving design
- Universal mounting holes for easy replacement
- Indication offered on CD blocks
- One hand release from DIN rail optional
- Rejection feature that prevents the insertion of fuses with lower interrupting rating or voltage ratings
- Clip design reduces resistance and heat
- Non DIN-rail fuse blocks have interlocking feature allowing ganging for any number of poles
- Covers available for all amperages to enhance safety
- Both hex and slot set screw options available on LFC Class CD 60 A box lugs

Specifications

Voltage Rating	600 V ac/dc
Ampere Ratings	L600M Midget (10x38): 30 A L600C Class CC: 30 A LFC Class CD: 60 A L600CM Class CC & Midget: 30 A
Dielectric strength	1200 V minimum
Materials	Clip/terminals: Tin-plated copper alloy Box lug: Copper Screw & captive pressure plate: Zinc-plated steel Base: Thermoplastic UL94 V-0 flammability rating
Withstand Rating (SCCR)	L60030C: 200 kA L60030M: 10 kA, 20 kA or 100 kA based on the Midget fuse used LFC600: 200 kA
Approvals	L600M: UL Recognized (File: E14721) CSA Certified (File: LR7316) L600C: UL Listed (File: E14721) CSA Certified (File: LR7316) LFC: UL Listed (File: E14721) CSA Certified (File: LR7316) L600CM: UL Recognized (File: E14721) CSA Certified (File: LR7316)
Environmental	RoHS Compliant, Lead (Pb) Free

Recommended Fuses

Class CC Blocks:	CCMR, KLDR, KLKR
Class CM Block:	Fuses same as CC & Midget Blocks
Class CD Blocks:	CCMR
Midget Blocks:	BLF, BLN, BLS, FLA, FLM, FLO, FLU, KLK, KLKD, KLO

Web Resources

Sample requests and technical downloads:
Littelfuse.com/fuseblocks

Ordering Information (L600C Class CC and L600M Midget 30 A)

AMP RATING	POLES	CLASS CC ORDERING NUMBER		MIDGET ORDERING NUMBER		CONNECTOR TYPE	TORQUE	WIRE RANGE	WIRE TYPE		BASE TEMP	COVER ORDERING NUMBER ¹
		NON-DIN*	DINR	NON-DIN*	DINR				CU ONLY	SOLID / STRANDED		
30	1	L60030C1C	L60030C1CDINR	L60030M1C	L60030M1CDINR	Box Lug	4.0 N-m (35 in-lbs)	6-14 AWG	CU Only	Solid / Stranded	125 °C	SPL001
	2	L60030C2C	L60030C2CDINR	L60030M2C	L60030M2CDINR							
	3	L60030C3C	L60030C3CDINR	L60030M3C	L60030M3CDINR							
30	1	L60030C1PQ	L60030C1PQDINR	L60030M1PQ	L60030M1PQDINR	Pressure Plate w/Q.C. Terminal	2.3 N-m (20 in-lbs)	10-14 AWG	CU Only	Solid / Stranded	125 °C	SPL001
	2	L60030C2PQ	L60030C2PQDINR	L60030M2PQ	L60030M2PQDINR							
	3	L60030C3PQ	L60030C3PQDINR	L60030M3PQ	L60030M3PQDINR							
30	1	L60030C1SQ	L60030C1SQDINR	L60030M1SQ	L60030M1SQDINR	Screw w/Q.C. Terminal	2.3 N-m (20 in-lbs)	10-14 AWG	CU Only	Solid / Stranded	125 °C	SPL001
	2	L60030C2SQ	L60030C2SQDINR	L60030M2SQ	L60030M2SQDINR							
	3	L60030C3SQ	L60030C3SQDINR	L60030M3SQ	L60030M3SQDINR							

Ordering Information (L600CM Class CC and Midget Combination 30 A)

AMP RATING	POLES		COMBINATION 2 CLASS CC / 1 MIDGET ORDERING NUMBER		CONNECTOR TYPE	TORQUE	WIRE RANGE	WIRE TYPE	BASE TEMP	COVER ORDERING NUMBER ¹
	CLASS CC	MIDGET	NON-DIN	DINR						
30	2	1	L60030CM3PQ	—	Pressure Plate w/Q.C. Terminal	2.3 N-m (20 in-lbs)	10-14 AWG	CU Only Solid / Stranded	125 °C	SPL001

* Gangable — ¹ Covers sold individually. One cover needed for each pole.

LF SERIES CLASS CC/CD AND MIDGET (10x38 mm) FUSE BLOCKS

Ordering Information (LFC Class CD 60 A)

AMP RATING	POLES	INDICATING ORDERING NUMBER	NON-INDICATING ORDERING NUMBER	CONNECTOR TYPE	TORQUE	WIRE RANGE	WIRE TYPE	BASE TEMP RATING	DIN RAIL MOUNT	COVER ORDERING NUMBER ¹
60	1	LFC600601CID	LFC600601C	Box Lug with Slot Screw	5.6 N-m (50 in-lbs)	2-4 AWG	CU-AL Solid / Stranded	125 °C	•	LFC60060FBC
	2	LFC600602CID	LFC600602C		2.8 N-m (25 in-lbs)	6-14 AWG				
	3	LFC600603CID	LFC600603C	5.6 N-m (50 in-lbs)	2-4 AWG					
60	1	LFC600601CID-HX	LFC600601C-HX	Box Lug with Hex Screw	5.6 N-m (50 in-lbs)	2-4 AWG				
	2	LFC600602CID-HX	LFC600602C-HX		2.8 N-m (25 in-lbs)	6-14 AWG				
	3	LFC600603CID-HX	LFC600603C-HX		2.8 N-m (25 in-lbs)	6-14 AWG				

¹ Covers sold individually. One cover needed for each pole.

Dimensions mm (inches)

L600M-DINR Midget and L600C-DINR Class CC 30 A

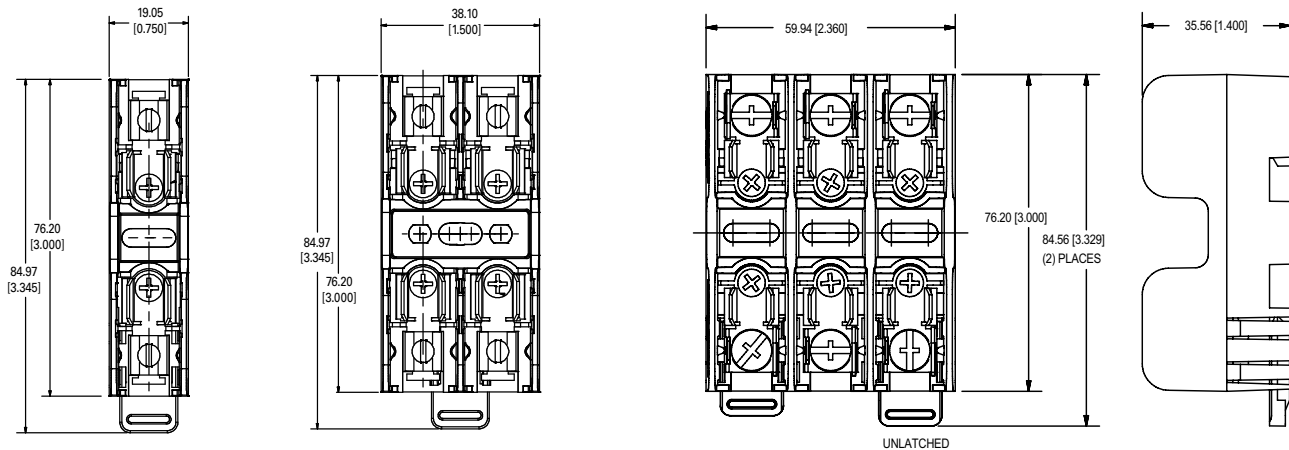

L600M Midget, L600C Class CC and L600CM Combination 30 A

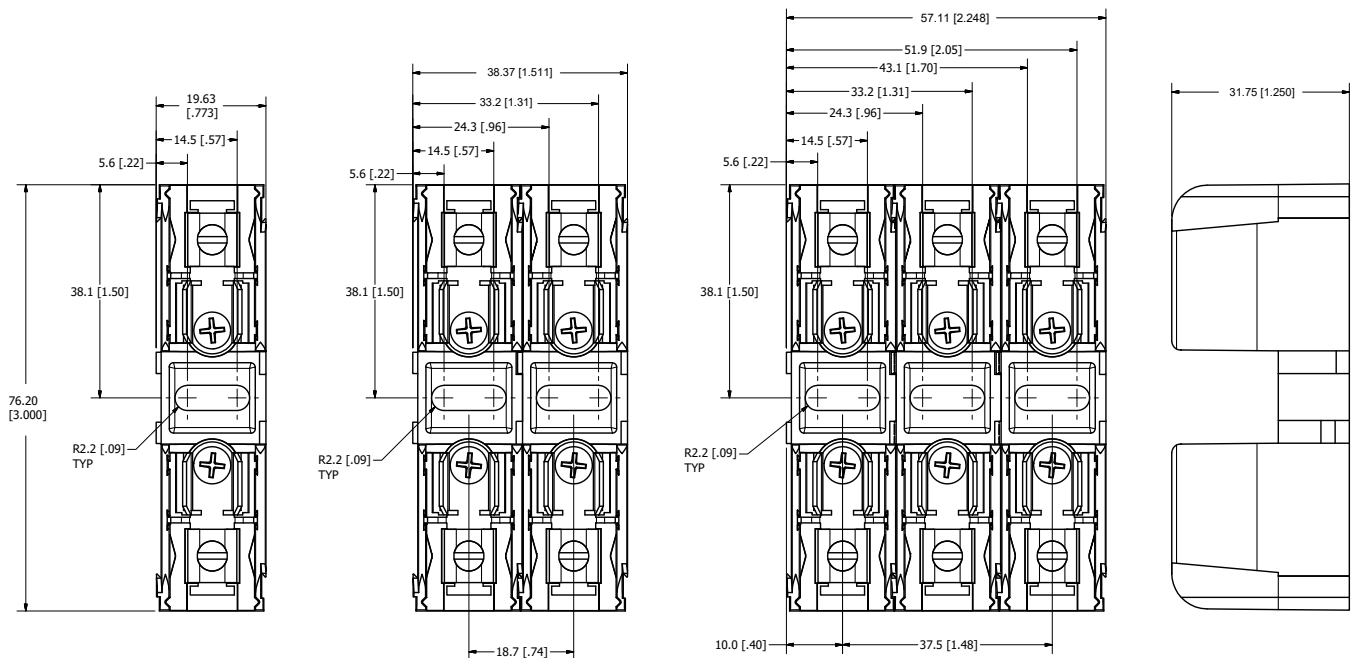

LF SERIES CLASS CC/CD AND MIDGET (10x38 mm) FUSE BLOCKS

Dimensions mm (inches)

LFC Class CD 60 A

