

CKT. SIZE	EDP. NO.	ENG. NO.	DIM. A REF.	DIM. B REF.
2	50-57-8902	70066-0351	(2.54) .100	(5.05) .199
3	50-57-8903	70066-0352	(5.08) .200	(7.59) .299
4	50-57-8904	70066-0353	(7.62) .300	(10.13) .399
5	50-57-8905	70066-0354	(10.16) .400	(12.67) .499
6	50-57-8906	70066-0355	(12.70) .500	(15.21) .599
7	50-57-8907	70066-0356	(15.24) .600	(17.75) .699
8	50-57-8908	70066-0357	(17.78) .700	(20.29) .799
9	50-57-8909	70066-0358	(20.32) .800	(22.83) .899
10	50-57-8910	70066-0359	(22.86) .900	(25.37) .999
11	NOT TOOLED	70066-0360	(25.40) 1.000	(27.91) 1.099
12	NOT TOOLED	70066-0361	(27.94) 1.100	(30.45) 1.199
13	NOT TOOLED	70066-0362	(30.48) 1.200	(32.99) 1.299
14	NOT TOOLED	70066-0363	(33.02) 1.300	(35.53) 1.399
15	NOT TOOLED	70066-0364	(35.56) 1.400	(38.07) 1.499
16	NOT TOOLED	70066-0365	(38.10) 1.500	(40.61) 1.599
17	NOT TOOLED	70066-0366	(40.64) 1.600	(43.15) 1.699
18	NOT TOOLED	70066-0367	(43.18) 1.700	(45.69) 1.799
19	NOT TOOLED	70066-0368	(45.72) 1.800	(48.23) 1.899
20	NOT TOOLED	70066-0369	(48.26) 1.900	(50.77) 1.999
21	NOT TOOLED	70066-0370	(50.80) 2.000	(53.31) 2.099
22	NOT TOOLED	70066-0371	(53.34) 2.100	(55.85) 2.199
23	NOT TOOLED	70066-0372	(55.88) 2.200	(58.39) 2.299
24	NOT TOOLED	70066-0373	(58.42) 2.300	(60.93) 2.399
25	NOT TOOLED	70066-0374	(60.96) 2.400	(63.47) 2.499

OPTION "M"

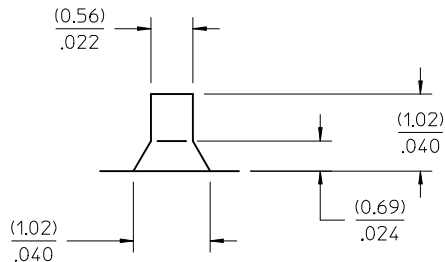

DETAIL "F"
TYP.
SCALE 20:1

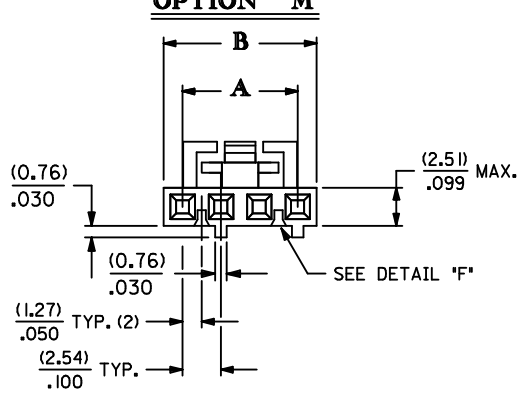
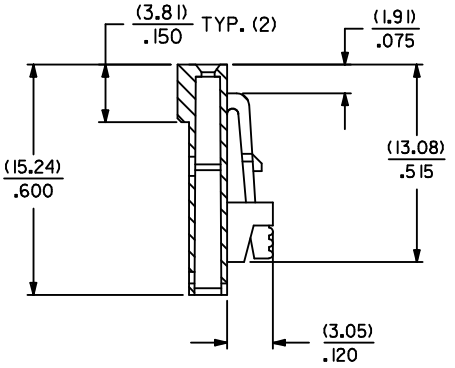
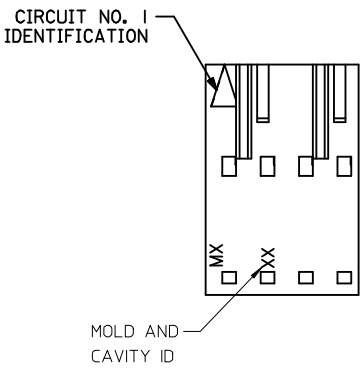

SECTION C-C

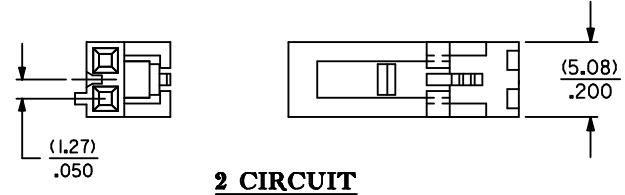
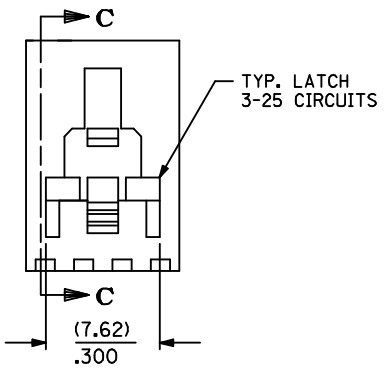

2 CIRCUIT

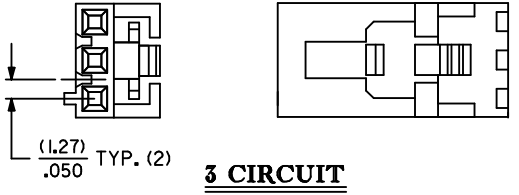

3 CIRCUIT

- NOTES:
1. MATERIAL GLASS FILLED POLYESTER; UL94V-0; COLOR: BLACK.
 2. HOUSING MAY BE USED WITH TERMINAL NUMBERS 70058, 71851, AND 70021.
 3. REFER TO CHART FOR AVAILABLE CIRCUIT SIZES.
 4. HOUSINGS TO BE USED WITH (0.64) .025 SQUARE OR ROUND PINS.
 5. REFER TO MOLEX PRODUCT SPECIFICATION(S): PS-70400, PS-70058, PS-71851, PS-70021, AND MOLEX APPLICATION SPECIFICATION SDES-70400.
 6. DIMENSIONS ARE SHOWN FOR REFERENCE ONLY.
 7. PACKAGE PER PK-70066-100.

LOCATE MOLD & CAVITY ID EC NO: UCP2014-4216 DRWNR:WHIPPLE 2014/04/11 CHKD:DMORGAN 2014/04/11 APPR:SMILLER 2014/04/28	QUALITY SYMBOLS ▽=0 ▽=0 ▽=0	GENERAL TOLERANCES (UNLESS SPECIFIED)		DIMENSION STYLE MM/IN	SCALE 4:1	DESIGN UNITS INCH	THIRD ANGLE PROJECTION	
		4 PLACES ± --- ± --- 3 PLACES ± --- ± .010 2 PLACES ± 0.25 ± .015 1 PLACE ± 0.38 ± --- 0 PLACE ± ±	DRAWN BY DATE DMORGAN 2011/11/14 CHECKED BY DATE SMR 1993/10/12 APPROVED BY DATE SMILLER 2012/02/13	TITLE HOUSING-CONNECTOR W/POLARIZATION SLOTS & RIBS (2.54) .100 GRID molex		MATERIAL NO. SEE CHART	DOCUMENT NO. SD-70066-0351-0374	SHEET NO. 1 OF 1
		ANGULAR ±1/2° DRAFT WHERE APPLICABLE MUST REMAIN WITHIN DIMENSIONS		SIZE C		THIS DRAWING CONTAINS INFORMATION THAT IS PROPRIETARY TO MOLEX INCORPORATED AND SHOULD NOT BE USED WITHOUT WRITTEN PERMISSION		