

Linear Voltage Regulator - Low Dropout, Ultra-Low Iq, Wide Input Voltage

50 mA

NCV8715

The NCV8715 is 50 mA LDO Linear Voltage Regulator. It is a very stable and accurate device with ultra-low ground current consumption (4.7 μ A over the full output load range) and a wide input voltage range (up to 24 V). The regulator incorporates several protection features such as Thermal Shutdown and Current Limiting.

Features

- Operating Input Voltage Range: 2.5 V to 24 V
- Fixed Voltage Options Available: 1.2 V to 5.0 V
- Ultra Low Quiescent Current: Max. 5.8 μ A Over Full Load and Temperature
- $\pm 2\%$ Accuracy Over Full Load, Line and Temperature Variations
- PSRR: 52 dB at 100 kHz
- Noise: 190 μ V_{RMS} from 200 Hz to 100 kHz
- Thermal Shutdown and Current Limit protection
- Available in XDFN6 1.5 x 1.5 mm and SC-70 (SC-88A) Package
- NCV Prefix for Automotive and Other Applications Requiring Unique Site and Control Change Requirements; AEC-Q100 Qualified and PPAP Capable; Device Temperature Grade 1: -40°C to +125°C Ambient Operating Temperature Range
- These Devices are Pb-Free, Halogen Free/BFR Free and are RoHS Compliant

Typical Applications

- Infotainment, Audio
- Communication Systems
- Safety Systems

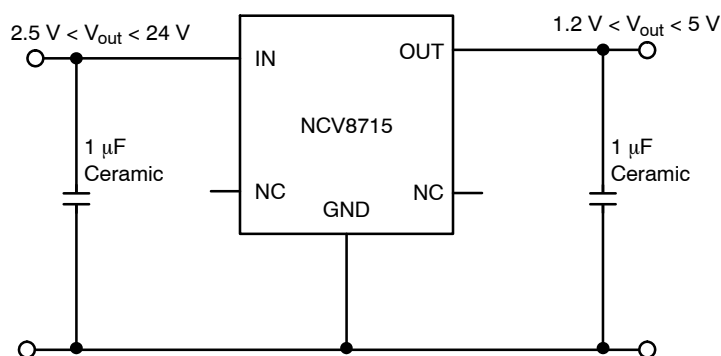
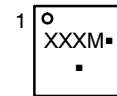

Figure 1. Typical Application Schematic



XDFN6
CASE 711AE

MARKING DIAGRAMS



SC-70-5
(SC-88A)
CASE 419A

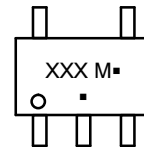

XXX = Specific Device Code
M = Date Code
▪ = Pb-Free Package

(Note: Microdot may be in either location)

ORDERING INFORMATION

See detailed ordering, marking and shipping information on page 19 of this data sheet.

NCV8715

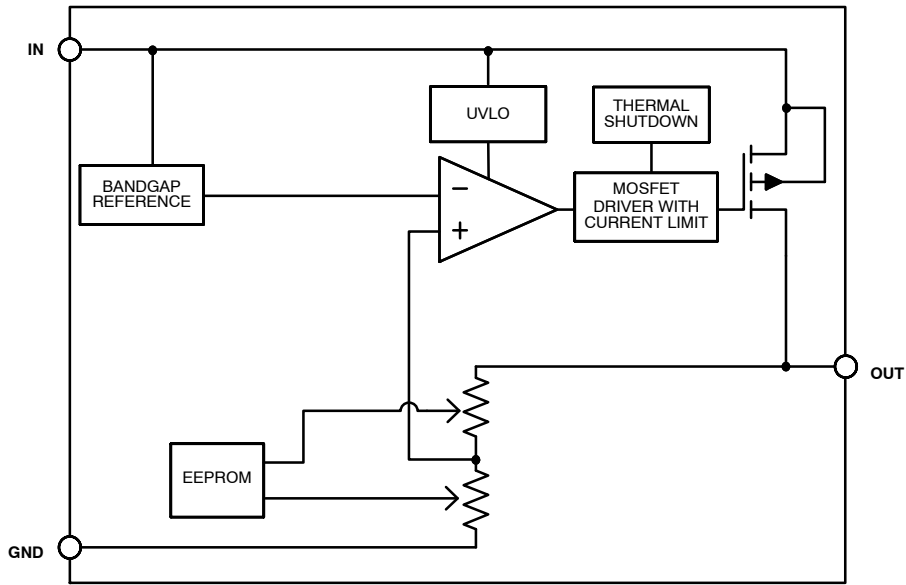
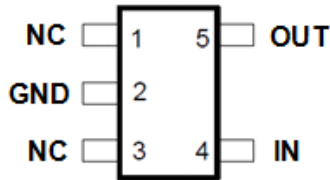

Figure 2. Simplified Block Diagram

**SC-88A (SC-70-5)
(Top View)**



**XDFN6 1.5x1.5, 0.5P
(Top View)**

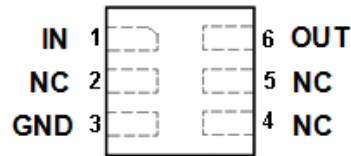

Figure 3. Pin Description

PIN FUNCTION DESCRIPTION

| Pin No. | | Pin Name | Description |
|---------|-------|----------|---|
| SC-70 | XDFN6 | | |
| 5 | 6 | OUT | Regulated output voltage pin. A small 0.47 μ F ceramic capacitor is needed from this pin to ground to assure stability. |
| 1 | 2 | N/C | No connection. This pin can be tied to ground to improve thermal dissipation or left disconnected. |
| 2 | 3 | GND | Power supply ground. |
| 3 | 4 | N/C | No connection. This pin can be tied to ground to improve thermal dissipation or left disconnected. |
| - | 5 | N/C | No connection. This pin can be tied to ground to improve thermal dissipation or left disconnected. |
| 4 | 1 | IN | Input pin. A small capacitor is needed from this pin to ground to assure stability. |

ABSOLUTE MAXIMUM RATINGS

| Rating | Symbol | Value | Unit |
|---|--------------------|------------|------|
| Input Voltage (Note 1) | V_{IN} | -0.3 to 24 | V |
| Output Voltage | V_{OUT} | -0.3 to 6 | V |
| Output Short Circuit Duration | t_{SC} | Indefinite | s |
| Maximum Junction Temperature | $T_{J(MAX)}$ | 150 | °C |
| Operating Ambient Temperature Range | T_A | -40 to 125 | °C |
| Storage Temperature Range | T_{STG} | -55 to 150 | °C |
| Moisture Sensitivity Level | MSL | MSL1 | - |
| ESD Capability, Human Body Model (Note 2) | ESD _{HBM} | 2000 | V |
| ESD Capability, Machine Model (Note 2) | ESD _{MM} | 200 | V |

Stresses exceeding Maximum Ratings may damage the device. Maximum Ratings are stress ratings only. Functional operation above the Recommended Operating Conditions is not implied. Extended exposure to stresses above the Recommended Operating Conditions may affect device reliability.

1. Refer to ELECTRICAL CHARACTERISTICS and APPLICATION INFORMATION for Safe Operating Area.
2. This device series incorporates ESD protection and is tested by the following methods:
 ESD Human Body Model tested per EIA/JESD22-A114
 ESD Machine Model tested per EIA/JESD22-A115
 ESD Charged Device Model tested per EIA/JESD22-C101E
 Latch up Current Maximum Rating tested per JEDEC standard: JESD78.

THERMAL CHARACTERISTICS

| Rating | Symbol | Value | Unit |
|---|-----------------|-------|------|
| Thermal Characteristics, SC-70 (Note 3) Thermal Resistance, Junction-to-Air (Note 4) | $R_{\theta JA}$ | 390 | °C/W |
| Thermal Characteristics, XDFN6 (Note 3) Thermal Resistance, Junction-to-Air (Note 4) | $R_{\theta JA}$ | 260 | °C/W |

3. Refer to ELECTRICAL CHARACTERISTICS and APPLICATION INFORMATION for Safe Operating Area.
4. As measured using a copper heat spreading area of 650 mm², 1 oz copper thickness.

RECOMMENDED OPERATING CONDITIONS

| Parameter | Symbol | Min | Max | Unit |
|----------------------|----------|-----|-----|------|
| Input Voltage | V_{IN} | 2.5 | 24 | V |
| Junction Temperature | T_J | -40 | 125 | °C |

Functional operation above the stresses listed in the Recommended Operating Ranges is not implied. Extended exposure to stresses beyond the Recommended Operating Ranges limits may affect device reliability.

NCV8715

ELECTRICAL CHARACTERISTICS – Voltage Version 1.2 V

$-40^{\circ}\text{C} \leq T_J \leq 125^{\circ}\text{C}$; $V_{IN} = 2.5\text{ V}$; $I_{OUT} = 1\text{ mA}$, $C_{IN} = C_{OUT} = 1.0\ \mu\text{F}$, unless otherwise noted. Typical values are at $T_J = +25^{\circ}\text{C}$. (Note 7)

| Parameter | Test Conditions | Symbol | Min | Typ | Max | Unit |
|---------------------------------------|--|---------------------------------------|-------|-----|-------|--------------------|
| Operating Input Voltage | $I_{OUT} \leq 10\text{ mA}$ | V_{IN} | 2.5 | | 24 | V |
| | $10\text{ mA} < I_{OUT} < 50\text{ mA}$ | | 3.0 | | 24 | |
| Output Voltage Accuracy | $3.0\text{ V} < V_{IN} < 24\text{ V}$, $0\text{ mA} < I_{OUT} < 50\text{ mA}$ | V_{OUT} | 1.164 | 1.2 | 1.236 | V |
| Line Regulation | $2.5\text{ V} \leq V_{IN} \leq 24\text{ V}$, $I_{OUT} = 1\text{ mA}$ | Reg_{LINE} | | 2 | 10 | mV |
| Load Regulation | $I_{OUT} = 0\text{ mA to } 50\text{ mA}$ | Reg_{LOAD} | | 5 | 10 | mV |
| Dropout Voltage (Note 5) | | V_{DO} | | | – | mV |
| Maximum Output Current | (Note 8) | I_{OUT} | 100 | | 200 | mA |
| | $0 < I_{OUT} < 50\text{ mA}$, $V_{IN} = 24\text{ V}$ | I_{GND} | | 3.4 | 5.8 | |
| Power Supply Rejection Ratio | $V_{IN} = 3.0\text{ V}$, $V_{OUT} = 1.2\text{ V}$ $V_{PP} = 200\text{ mV}$ modulation $I_{OUT} = 1\text{ mA}$, $C_{OUT} = 10\ \mu\text{F}$ | $f = 100\text{ kHz}$ PSRR | | 60 | | dB |
| Output Noise Voltage | $V_{OUT} = 1.2\text{ V}$, $I_{OUT} = 50\text{ mA}$ $f = 200\text{ Hz to } 100\text{ kHz}$, $C_{OUT} = 10\ \mu\text{F}$ | V_N | | 65 | | |
| Thermal Shutdown Temperature (Note 6) | Temperature increasing from $T_J = +25^{\circ}\text{C}$ | T_{SD} | | 170 | | $^{\circ}\text{C}$ |
| Thermal Shutdown Hysteresis (Note 6) | Temperature falling from T_{SD} | T_{SDH} | – | 15 | – | $^{\circ}\text{C}$ |

Product parametric performance is indicated in the Electrical Characteristics for the listed test conditions, unless otherwise noted. Product performance may not be indicated by the Electrical Characteristics if operated under different conditions.

5. Not Characterized at $V_{IN} = 3.0\text{ V}$, $V_{OUT} = 1.2\text{ V}$, $I_{OUT} = 50\text{ mA}$.

6. Guaranteed by design and characterization.

7. Performance guaranteed over the indicated operating temperature range by design and/or characterization production tested at $T_J = T_A = 25^{\circ}\text{C}$. Low duty cycle pulse techniques are used during testing to maintain the junction temperature as close to ambient as possible.

8. Respect SOA.

NCV8715

ELECTRICAL CHARACTERISTICS – Voltage Version 1.5 V

$-40^{\circ}\text{C} \leq T_J \leq 125^{\circ}\text{C}$; $V_{IN} = 2.5\text{ V}$; $I_{OUT} = 1\text{ mA}$, $C_{IN} = C_{OUT} = 1.0\text{ }\mu\text{F}$, unless otherwise noted. Typical values are at $T_J = +25^{\circ}\text{C}$. (Note 11)

| Parameter | Test Conditions | Symbol | Min | Typ | Max | Unit |
|--|--|---------------------------------------|-------|-----|-------|---------------------|
| Operating Input Voltage | $I_{OUT} \leq 10\text{ mA}$ | V_{IN} | 2.5 | | 24 | V |
| | $10\text{ mA} < I_{OUT} < 50\text{ mA}$ | | 3.0 | | 24 | |
| Output Voltage Accuracy | $3.0\text{ V} < V_{IN} < 24\text{ V}$, $0 < I_{OUT} < 50\text{ mA}$ | V_{OUT} | 1.455 | 1.5 | 1.545 | V |
| Line Regulation | $V_{OUT} + 1\text{ V} \leq V_{IN} \leq 24\text{ V}$, $I_{OUT} = 1\text{ mA}$ | Reg_{LINE} | | 2 | 10 | mV |
| Load Regulation | $I_{OUT} = 0\text{ mA to } 50\text{ mA}$ | Reg_{LOAD} | | 5 | 10 | mV |
| Dropout Voltage (Note 9) | | V_{DO} | | | – | mV |
| Maximum Output Current | (Note 12) | I_{OUT} | 100 | | 200 | mA |
| Ground Current | $0 < I_{OUT} < 50\text{ mA}$, $V_{IN} = 24\text{ V}$ | I_{GND} | | 3.4 | 5.8 | μA |
| Power Supply Rejection Ratio | $V_{IN} = 3.0\text{ V}$, $V_{OUT} = 1.5\text{ V}$ $V_{PP} = 200\text{ mV modulation}$ $I_{OUT} = 1\text{ mA}$, $C_{OUT} = 10\text{ }\mu\text{F}$ | $f = 100\text{ kHz}$ PSRR | | 56 | | dB |
| Output Noise Voltage | $V_{OUT} = 1.5\text{ V}$, $I_{OUT} = 50\text{ mA}$ $f = 200\text{ Hz to } 100\text{ kHz}$, $C_{OUT} = 10\text{ }\mu\text{F}$ | V_N | | 75 | | μV_{rms} |
| Thermal Shutdown Temperature (Note 10) | Temperature increasing from $T_J = +25^{\circ}\text{C}$ | T_{SD} | | 170 | | $^{\circ}\text{C}$ |
| Thermal Shutdown Hysteresis (Note 10) | Temperature falling from T_{SD} | T_{SDH} | – | 15 | – | $^{\circ}\text{C}$ |

9. Not Characterized at $V_{IN} = 3.0\text{ V}$, $V_{OUT} = 1.5\text{ V}$, $I_{OUT} = 50\text{ mA}$.

10. Guaranteed by design and characterization.

11. Performance guaranteed over the indicated operating temperature range by design and/or characterization production tested at

$T_J = T_A = 25^{\circ}\text{C}$. Low duty cycle pulse techniques are used during testing to maintain the junction temperature as close to ambient as possible.

12. Respect SOA.

NCV8715

ELECTRICAL CHARACTERISTICS – Voltage Version 1.8 V

$-40^{\circ}\text{C} \leq T_J \leq 125^{\circ}\text{C}$; $V_{IN} = 2.8\text{V}$; $I_{OUT} = 1\text{ mA}$, $C_{IN} = C_{OUT} = 1.0\ \mu\text{F}$, unless otherwise noted. Typical values are at $T_J = +25^{\circ}\text{C}$. (Note 15)

| Parameter | Test Conditions | Symbol | Min | Typ | Max | Unit |
|--|--|---------------------------------------|-------|-----|-------|---------------------|
| Operating Input Voltage | $I_{OUT} \leq 10\text{ mA}$ | V_{IN} | 2.8 | | 24 | V |
| | $10\text{ mA} < I_{OUT} < 50\text{ mA}$ | | 3.0 | | 24 | |
| Output Voltage Accuracy | $3.0\text{ V} < V_{IN} < 24\text{ V}$, $0 < I_{OUT} < 10\text{ mA}$ | V_{OUT} | 1.746 | 1.8 | 1.854 | V |
| Line Regulation | $3\text{ V} \leq V_{IN} \leq 24\text{ V}$, $I_{OUT} = 1\text{ mA}$ | Reg_{LINE} | | 2 | 10 | mV |
| Load Regulation | $I_{OUT} = 0\text{ mA to } 50\text{ mA}$ | Reg_{LOAD} | | 5 | 10 | mV |
| Dropout Voltage (Note 13) | | V_{DO} | | | | mV |
| Maximum Output Current | (Note 16) | I_{OUT} | 100 | | 200 | mA |
| Ground Current | $0 < I_{OUT} < 50\text{ mA}$, $V_{IN} = 24\text{ V}$ | I_{GND} | | 3.4 | 5.8 | μA |
| Power Supply Rejection Ratio | $V_{IN} = 3.0\text{ V}$, $V_{OUT} = 1.8\text{ V}$ $V_{PP} = 200\text{ mV modulation}$ $I_{OUT} = 1\text{ mA}$, $C_{OUT} = 10\ \mu\text{F}$ | $f = 100\text{ kHz}$ PSRR | | 60 | | dB |
| Output Noise Voltage | $V_{OUT} = 1.8\text{ V}$, $I_{OUT} = 50\text{ mA}$ $f = 200\text{ Hz to } 100\text{ kHz}$, $C_{OUT} = 10\ \mu\text{F}$ | V_N | | 95 | | μV_{rms} |
| Thermal Shutdown Temperature (Note 14) | Temperature increasing from $T_J = +25^{\circ}\text{C}$ | T_{SD} | | 170 | | $^{\circ}\text{C}$ |
| Thermal Shutdown Hysteresis (Note 14) | Temperature falling from T_{SD} | T_{SDH} | – | 15 | – | $^{\circ}\text{C}$ |

13. Not characterized at $V_{IN} = 3.0\text{ V}$, $V_{OUT} = 1.8\text{ V}$, $I_{OUT} = 50\text{ mA}$

14. Guaranteed by design and characterization.

15. Performance guaranteed over the indicated operating temperature range by design and/or characterization production tested at $T_J = T_A = 25^{\circ}\text{C}$. Low duty cycle pulse techniques are used during testing to maintain the junction temperature as close to ambient as possible.

16. Respect SOA.

NCV8715

ELECTRICAL CHARACTERISTICS – Voltage Version 2.1 V

$-40^{\circ}\text{C} \leq T_J \leq 125^{\circ}\text{C}$; $V_{IN} = 3.1\text{V}$; $I_{OUT} = 1\text{ mA}$, $C_{IN} = C_{OUT} = 1.0\ \mu\text{F}$, unless otherwise noted. Typical values are at $T_J = +25^{\circ}\text{C}$. (Note 19)

| Parameter | Test Conditions | Symbol | Min | Typ | Max | Unit |
|--|---|---------------------------------------|-------|-----|-------|----------------------------|
| Operating Input Voltage | $0 < I_{OUT} < 50\text{ mA}$ | V_{IN} | 3.1 | | 24 | V |
| Output Voltage Accuracy | $3.1\text{ V} < V_{IN} < 24\text{ V}$, $0 < I_{OUT} < 50\text{ mA}$ | V_{OUT} | 2.058 | 2.1 | 2.142 | V |
| Line Regulation | $3.1\text{ V} \leq V_{IN} \leq 24\text{ V}$, $I_{OUT} = 1\text{ mA}$ | Reg_{LINE} | | 3 | 45 | mV |
| | $3.3\text{ V} \leq V_{IN} \leq 24\text{ V}$, $I_{OUT} = 1\text{ mA}$ | | | 3 | 10 | |
| Load Regulation | $I_{OUT} = 0\text{ mA to } 50\text{ mA}$ | Reg_{LOAD} | | 10 | 15 | mV |
| Dropout Voltage (Note 17) | | V_{DO} | | | | mV |
| Maximum Output Current | (Note 20) | I_{OUT} | 100 | | 200 | mA |
| Ground Current | $0 < I_{OUT} < 50\text{ mA}$, $V_{IN} = 24\text{ V}$ | I_{GND} | | 3.4 | 5.8 | μA |
| Power Supply Rejection Ratio | $V_{IN} = 3.1\text{ V}$, $V_{OUT} = 2.1\text{ V}$ $V_{\text{PP}} = 200\text{ mV}$ modulation $I_{OUT} = 1\text{ mA}$, $C_{OUT} = 10\ \mu\text{F}$ | $f = 100\text{ kHz}$ PSRR | | 60 | | dB |
| Output Noise Voltage | $V_{OUT} = 2.1\text{ V}$, $I_{OUT} = 50\text{ mA}$ $f = 200\text{ Hz to } 100\text{ kHz}$, $C_{OUT} = 10\ \mu\text{F}$ | V_N | | 105 | | μV_{rms} |
| Thermal Shutdown Temperature (Note 18) | Temperature increasing from $T_J = +25^{\circ}\text{C}$ | T_{SD} | | 170 | | $^{\circ}\text{C}$ |
| Thermal Shutdown Hysteresis (Note 18) | Temperature falling from T_{SD} | T_{SDH} | – | 15 | – | $^{\circ}\text{C}$ |

17. Not characterized at $V_{IN} = 3.1\text{ V}$, $V_{OUT} = 2.1\text{ V}$, $I_{OUT} = 50\text{ mA}$

18. Guaranteed by design and characterization.

19. Performance guaranteed over the indicated operating temperature range by design and/or characterization production tested at $T_J = T_A = 25^{\circ}\text{C}$. Low duty cycle pulse techniques are used during testing to maintain the junction temperature as close to ambient as possible.

20. Respect SOA.

NCV8715

ELECTRICAL CHARACTERISTICS – Voltage Version 2.5 V

$-40^{\circ}\text{C} \leq T_J \leq 125^{\circ}\text{C}$; $V_{IN} = 3.5\text{ V}$; $I_{OUT} = 1\text{ mA}$, $C_{IN} = C_{OUT} = 1.0\text{ }\mu\text{F}$, unless otherwise noted. Typical values are at $T_J = +25^{\circ}\text{C}$. (Note 23)

| Parameter | Test Conditions | Symbol | Min | Typ | Max | Unit |
|--|--|---------------------------------------|------|-----|------|---------------------|
| Operating Input Voltage | $0 < I_{OUT} < 50\text{ mA}$ | V_{IN} | 3.5 | | 24 | V |
| Output Voltage Accuracy | $3.5\text{ V} < V_{IN} < 24\text{ V}$, $0 < I_{OUT} < 50\text{ mA}$ | V_{OUT} | 2.45 | 2.5 | 2.55 | V |
| Line Regulation | $V_{OUT} + 1\text{ V} \leq V_{IN} \leq 24\text{ V}$, $I_{OUT} = 1\text{ mA}$ | Reg _{LINE} | | 3 | 10 | mV |
| Load Regulation | $I_{OUT} = 0\text{ mA}$ to 50 mA | Reg _{LOAD} | | 10 | 15 | mV |
| Dropout Voltage (Note 21) | $V_{DO} = V_{IN} - (V_{OUT(NOM)} - 125\text{ mV})$ $I_{OUT} = 50\text{ mA}$ | V_{DO} | | 260 | 450 | mV |
| Maximum Output Current | (Note 24) | I_{OUT} | 100 | | 200 | mA |
| Ground Current | $0 < I_{OUT} < 50\text{ mA}$, $V_{IN} = 24\text{ V}$ | I_{GND} | | 3.4 | 5.8 | μA |
| Power Supply Rejection Ratio | $V_{IN} = 3.5\text{ V}$, $V_{OUT} = 2.5\text{ V}$ $V_{PP} = 200\text{ mV}$ modulation $I_{OUT} = 1\text{ mA}$, $C_{OUT} = 10\text{ }\mu\text{F}$ | $f = 100\text{ kHz}$ PSRR | | 60 | | dB |
| Output Noise Voltage | $V_{OUT} = 2.5\text{ V}$, $I_{OUT} = 50\text{ mA}$ $f = 200\text{ Hz}$ to 100 kHz , $C_{OUT} = 10\text{ }\mu\text{F}$ | V_N | | 115 | | μV_{rms} |
| Thermal Shutdown Temperature (Note 22) | Temperature increasing from $T_J = +25^{\circ}\text{C}$ | T_{SD} | | 170 | | $^{\circ}\text{C}$ |
| Thermal Shutdown Hysteresis (Note 22) | Temperature falling from T_{SD} | T_{SDH} | – | 15 | – | $^{\circ}\text{C}$ |

21. Characterized when V_{OUT} falls 125 mV below the regulated voltage and only for devices with $V_{OUT} = 2.5\text{ V}$.

22. Guaranteed by design and characterization.

23. Performance guaranteed over the indicated operating temperature range by design and/or characterization production tested at

$T_J = T_A = 25^{\circ}\text{C}$. Low duty cycle pulse techniques are used during testing to maintain the junction temperature as close to ambient as possible.

24. Respect SOA.

NCV8715

ELECTRICAL CHARACTERISTICS – Voltage Version 3.0 V

$-40^{\circ}\text{C} \leq T_J \leq 125^{\circ}\text{C}$; $V_{IN} = 4.0\text{ V}$; $I_{OUT} = 1\text{ mA}$, $C_{IN} = C_{OUT} = 1.0\ \mu\text{F}$, unless otherwise noted. Typical values are at $T_J = +25^{\circ}\text{C}$. (Note 27)

| Parameter | Test Conditions | Symbol | Min | Typ | Max | Unit |
|--|--|---------------------------------------|------|-----|------|---------------------|
| Operating Input Voltage | $0 < I_{OUT} < 50\text{ mA}$ | V_{IN} | 4.0 | | 24 | V |
| Output Voltage Accuracy | $4.0\text{ V} < V_{IN} < 24\text{ V}$, $0 < I_{OUT} < 50\text{ mA}$ | V_{OUT} | 2.94 | 3.0 | 3.06 | V |
| Line Regulation | $V_{OUT} + 1\text{ V} \leq V_{IN} \leq 24\text{ V}$, $I_{OUT} = 1\text{ mA}$ | Reg _{LINE} | | 3 | 10 | mV |
| Load Regulation | $I_{OUT} = 0\text{ mA to } 50\text{ mA}$ | Reg _{LOAD} | | 10 | 15 | mV |
| Dropout voltage (Note 25) | $V_{DO} = V_{IN} - (V_{OUT(NOM)} - 150\text{ mV})$ $I_{OUT} = 50\text{ mA}$ | V_{DO} | | 250 | 400 | mV |
| Maximum Output Current | (Note 28) | I_{OUT} | 100 | | 200 | mA |
| Ground current | $0 < I_{OUT} < 50\text{ mA}$, $V_{IN} = 24\text{ V}$ | I_{GND} | | 3.4 | 5.8 | μA |
| Power Supply Rejection Ratio | $V_{IN} = 4.0\text{ V}$, $V_{OUT} = 3.0\text{ V}$ $V_{PP} = 100\text{ mV modulation}$ $I_{OUT} = 1\text{ mA}$, $C_{OUT} = 10\ \mu\text{F}$ | $f = 100\text{ kHz}$ PSRR | | 60 | | dB |
| Output Noise Voltage | $V_{OUT} = 3\text{ V}$, $I_{OUT} = 50\text{ mA}$, $f = 200\text{ Hz to } 100\text{ kHz}$, $C_{OUT} = 10\ \mu\text{F}$ | V_N | | 135 | | μV_{rms} |
| Thermal Shutdown Temperature (Note 26) | Temperature increasing from $T_J = +25^{\circ}\text{C}$ | T_{SD} | | 170 | | $^{\circ}\text{C}$ |
| Thermal Shutdown Hysteresis (Note 26) | Temperature falling from T_{SD} | T_{SDH} | - | 25 | - | $^{\circ}\text{C}$ |

25. Characterized when V_{OUT} falls 150 mV below the regulated voltage and only for devices with $V_{OUT} = 3.0\text{ V}$

26. Guaranteed by design and characterization.

27. Performance guaranteed over the indicated operating temperature range by design and/or characterization production tested at $T_J = T_A = 25^{\circ}\text{C}$. Low duty cycle pulse techniques are used during testing to maintain the junction temperature as close to ambient as possible.

28. Respect SOA

NCV8715

ELECTRICAL CHARACTERISTICS – Voltage Version 3.3 V

$-40^{\circ}\text{C} \leq T_J \leq 125^{\circ}\text{C}$; $V_{IN} = 4.3\text{ V}$; $I_{OUT} = 1\text{ mA}$, $C_{IN} = C_{OUT} = 1.0\ \mu\text{F}$, unless otherwise noted. Typical values are at $T_J = +25^{\circ}\text{C}$. (Note 31)

| Parameter | Test Conditions | Symbol | Min | Typ | Max | Unit |
|--|--|------------------------------|-------|-----|-------|---------------------|
| Operating Input Voltage | $0 < I_{OUT} < 50\text{ mA}$ | V_{IN} | 4.3 | | 24 | V |
| Output Voltage Accuracy | $4.3\text{ V} < V_{IN} < 24\text{ V}$, $0 < I_{OUT} < 50\text{ mA}$ | V_{OUT} | 3.234 | 3.3 | 3.366 | V |
| Line Regulation | $V_{OUT} + 1\text{ V} \leq V_{IN} \leq 24\text{ V}$, $I_{OUT} = 1\text{ mA}$ | Reg _{LINE} | | 3 | 10 | mV |
| Load Regulation | $I_{OUT} = 0\text{ mA}$ to 50 mA | Reg _{LOAD} | | 10 | 15 | mV |
| Dropout Voltage (Note 29) | $V_{DO} = V_{IN} - (V_{OUT(NOM)} - 165\text{ mV})$ $I_{OUT} = 50\text{ mA}$ | V_{DO} | | 230 | 350 | mV |
| Maximum Output Current | (Note 32) | I_{OUT} | 100 | | 200 | mA |
| Ground Current | $0 < I_{OUT} < 50\text{ mA}$, $V_{IN} = 24\text{ V}$ | I_{GND} | | 3.4 | 5.8 | μA |
| Power Supply Rejection Ratio | $V_{IN} = 4.3\text{ V}$, $V_{OUT} = 3.3\text{ V}$ $V_{PP} = 200\text{ mV}$ modulation $I_{OUT} = 1\text{ mA}$, $C_{OUT} = 10\ \mu\text{F}$ | $f = 100\text{ kHz}$ PSRR | | 60 | | dB |
| Output Noise Voltage | $V_{OUT} = 4.3\text{ V}$, $I_{OUT} = 50\text{ mA}$ $f = 200\text{ Hz}$ to 100 kHz , $C_{OUT} = 10\ \mu\text{F}$ | V_N | | 140 | | μV_{rms} |
| Thermal Shutdown Temperature (Note 30) | Temperature increasing from $T_J = +25^{\circ}\text{C}$ | T_{SD} | | 170 | | $^{\circ}\text{C}$ |
| Thermal Shutdown Hysteresis (Note 30) | Temperature falling from T_{SD} | T_{SDH} | – | 15 | – | $^{\circ}\text{C}$ |

29. Characterized when V_{OUT} falls 165 mV below the regulated voltage and only for devices with $V_{OUT} = 3.3\text{ V}$.

30. Guaranteed by design and characterization.

31. Performance guaranteed over the indicated operating temperature range by design and/or characterization production tested at $T_J = T_A = 25^{\circ}\text{C}$. Low duty cycle pulse techniques are used during testing to maintain the junction temperature as close to ambient as possible.

32. Respect SOA.

NCV8715

ELECTRICAL CHARACTERISTICS – Voltage Version 5.0 V

$-40^{\circ}\text{C} \leq T_J \leq 125^{\circ}\text{C}$; $V_{IN} = 6.0\text{ V}$; $I_{OUT} = 1\text{ mA}$, $C_{IN} = C_{OUT} = 1\text{ }\mu\text{F}$, unless otherwise noted. Typical values are at $T_J = +25^{\circ}\text{C}$. (Note 35)

| Parameter | Test Conditions | Symbol | Min | Typ | Max | Unit |
|--|--|--------------------------------|-----|-----|-----|---------------------|
| Operating Input Voltage | $0 < I_{OUT} < 50\text{ mA}$ | V_{IN} | 6.0 | | 24 | V |
| Output Voltage Accuracy | $6.0\text{V} < V_{IN} < 24\text{V}$, $0 < I_{OUT} < 50\text{ mA}$ | V_{OUT} | 4.9 | 5.0 | 5.1 | V |
| Line Regulation | $V_{OUT} + 1\text{ V} \leq V_{IN} \leq 24\text{ V}$, $I_{OUT} = 1\text{ mA}$ | Reg_{LINE} | | 3 | 10 | mV |
| Load Regulation | $I_{OUT} = 0\text{ mA}$ to 50 mA | Reg_{LOAD} | | 10 | 20 | mV |
| Dropout Voltage (Note 33) | $V_{DO} = V_{IN} - (V_{OUT(NOM)} - 250\text{ mV})$ $I_{OUT} = 50\text{ mA}$ | V_{DO} | | 230 | 350 | mV |
| Maximum Output Current | (Note 36) | I_{OUT} | 90 | | 200 | mA |
| Ground Current | $0 < I_{OUT} < 50\text{ mA}$, $V_{IN} = 24\text{ V}$ | I_{GND} | | 3.4 | 5.8 | μA |
| Power Supply Rejection Ratio | $V_{IN} = 6.0\text{ V}$, $V_{OUT} = 5.0\text{ V}$ $V_{PP} = 200\text{ mV}$ modulation $I_{OUT} = 1\text{ mA}$, $C_{OUT} = 10\text{ }\mu\text{F}$ | $f = 100\text{ kHz}$ $PSRR$ | | 56 | | dB |
| Output Noise Voltage | $V_{OUT} = 5.0\text{ V}$, $I_{OUT} = 50\text{ mA}$ $f = 200\text{ Hz}$ to 100 kHz , $C_{OUT} = 10\text{ }\mu\text{F}$ | V_N | | 190 | | μV_{rms} |
| Thermal Shutdown Temperature (Note 34) | Temperature increasing from $T_J = +25^{\circ}\text{C}$ | T_{SD} | | 170 | | $^{\circ}\text{C}$ |
| Thermal Shutdown Hysteresis (Note 34) | Temperature falling from T_{SD} | T_{SDH} | – | 15 | – | $^{\circ}\text{C}$ |

33. Characterized when V_{OUT} falls 250 mV below the regulated voltage and only for devices with $V_{OUT} = 5.0\text{ V}$.

34. Guaranteed by design and characterization.

35. Performance guaranteed over the indicated operating temperature range by design and/or characterization production tested at $T_J = T_A = 25^{\circ}\text{C}$. Low duty cycle pulse techniques are used during testing to maintain the junction temperature as close to ambient as possible.

36. Respect SOA.

NCV8715

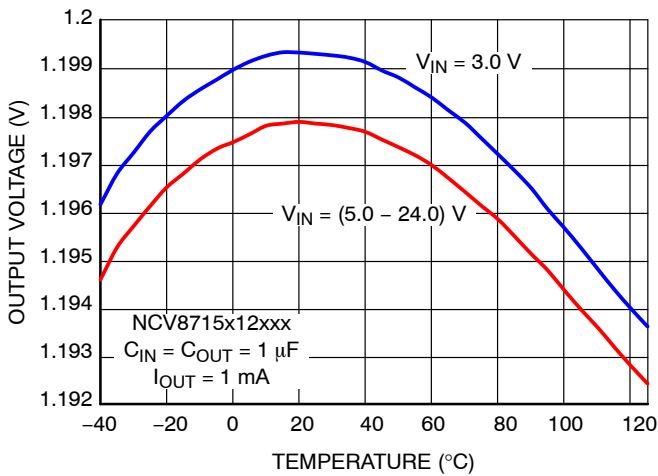

Figure 4. Output Voltage vs. Temperature

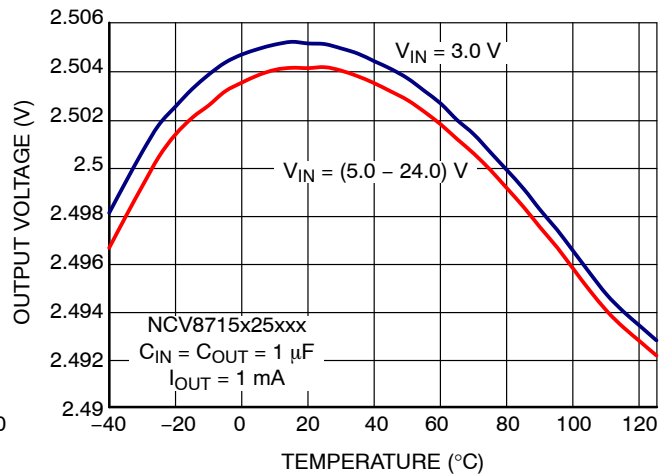

Figure 5. Output Voltage vs. Temperature

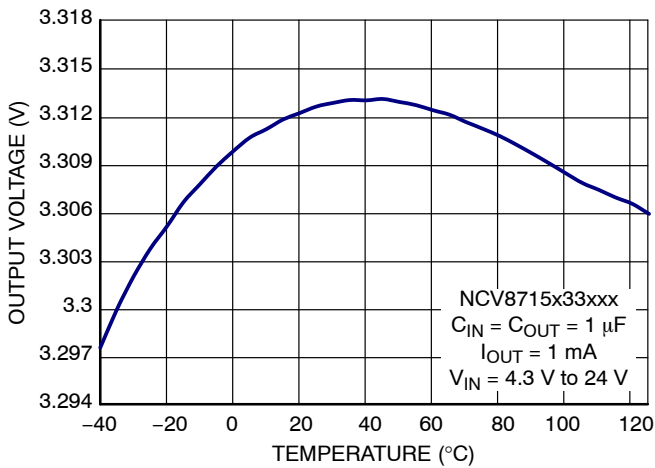

Figure 6. Output Voltage vs. Temperature

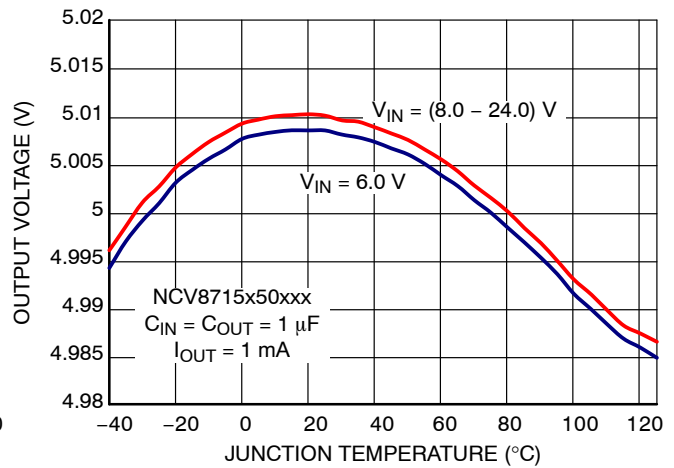

Figure 7. Output Voltage vs. Temperature

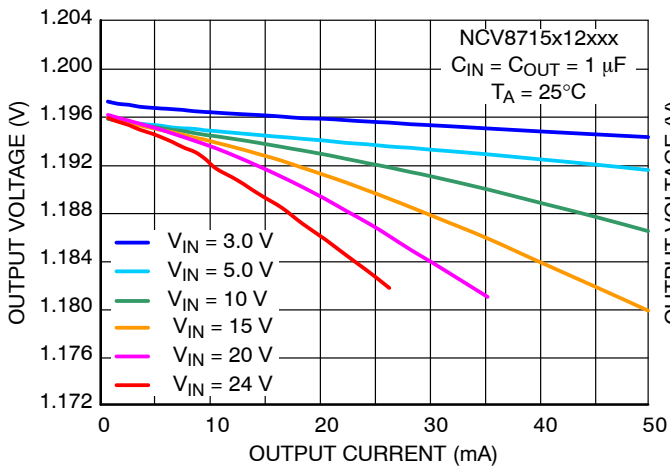

Figure 8. Output Voltage vs. Output Current

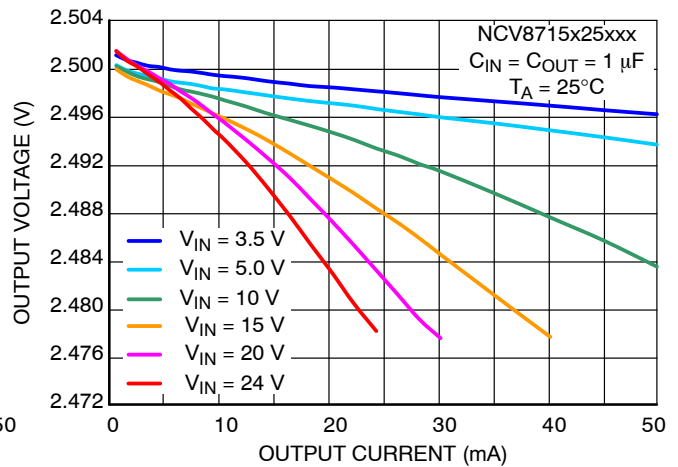

Figure 9. Output Voltage vs. Output Current

NCV8715

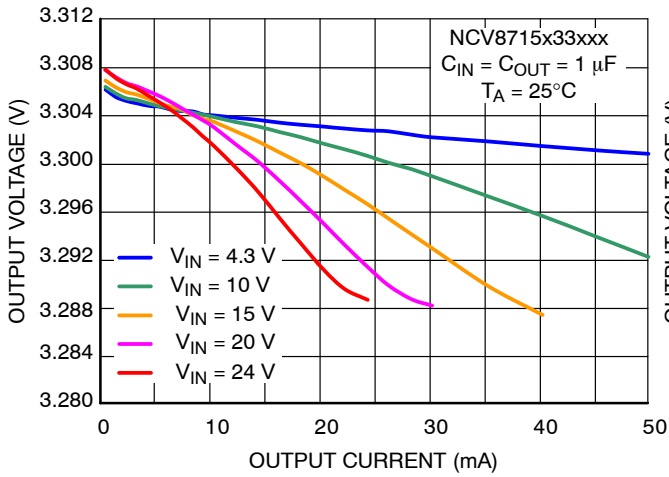

Figure 10. Output Voltage vs. Output Current

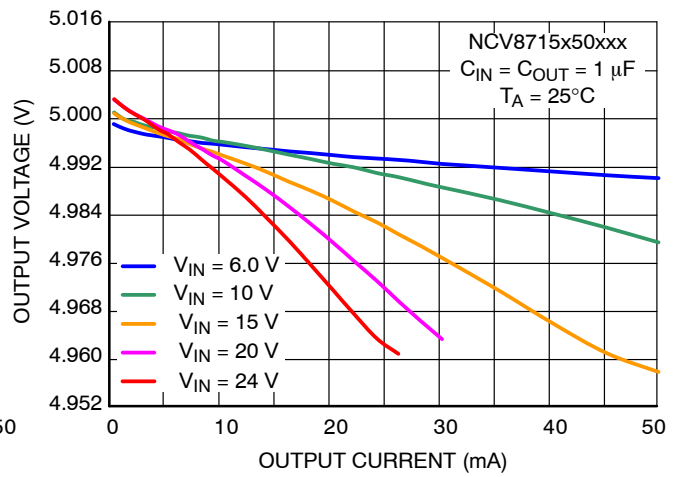

Figure 11. Output Voltage vs. Output Current

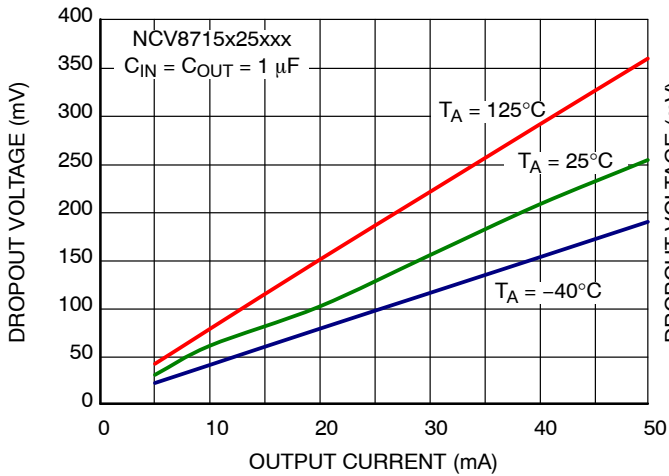

Figure 12. Dropout Voltage vs. Output Current

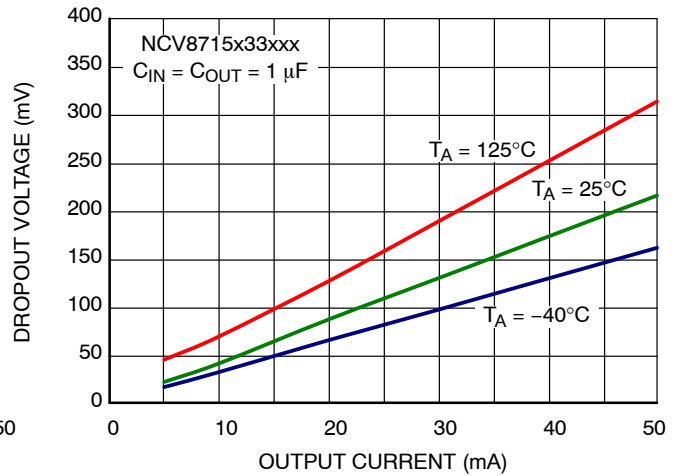

Figure 13. Dropout Voltage vs. Output Current

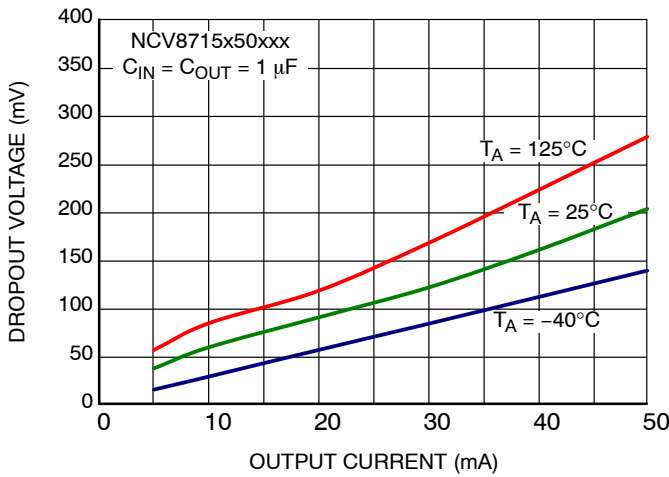

Figure 14. Dropout Voltage vs. Output Current

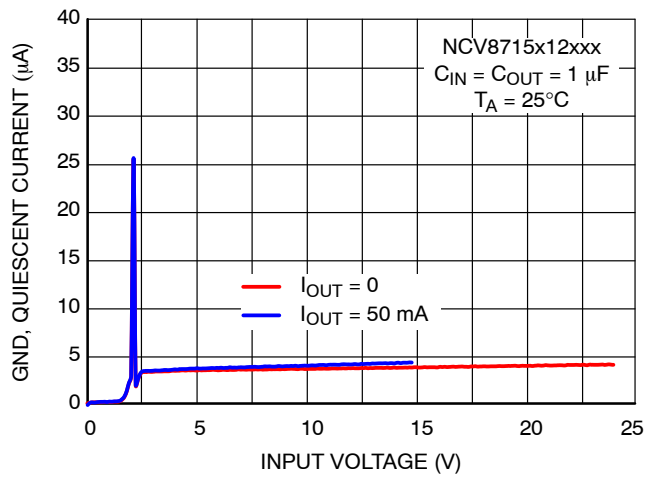

Figure 15. Ground Current vs. Input Voltage

NCV8715

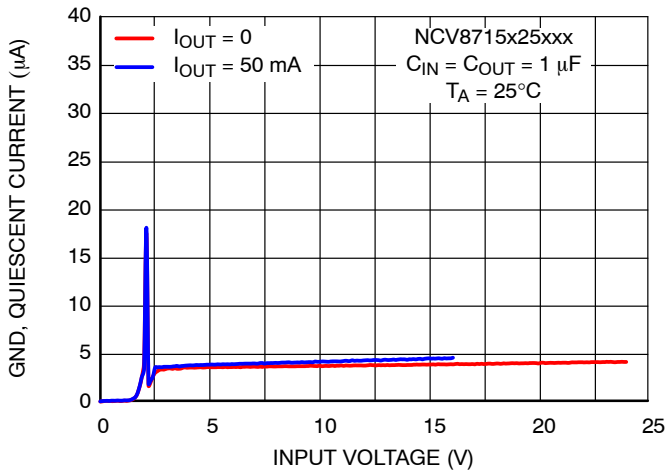

Figure 16. Ground Current vs. Input Voltage

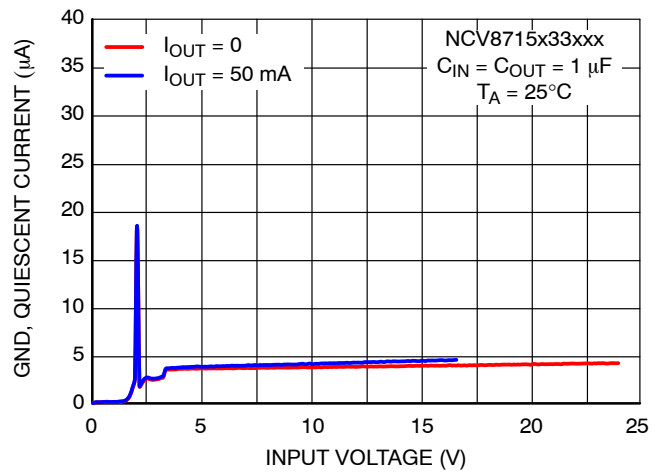

Figure 17. Ground Current vs. Input Voltage

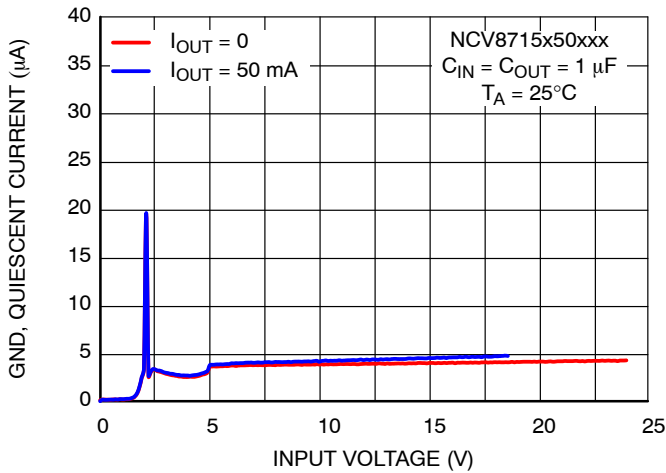

Figure 18. Ground Current vs. Input Voltage

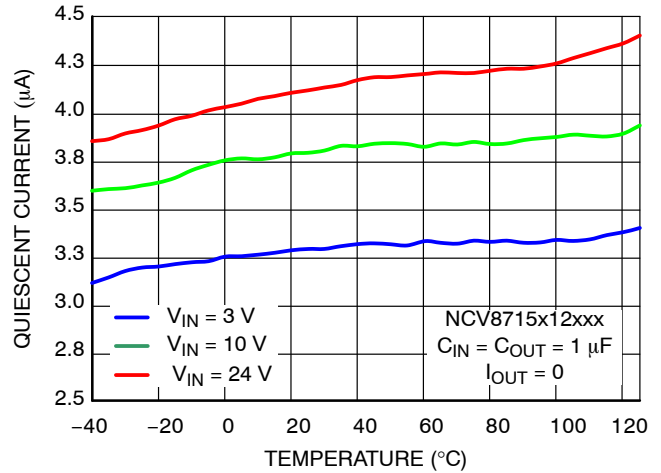

Figure 19. Quiescent Current vs. Temperature

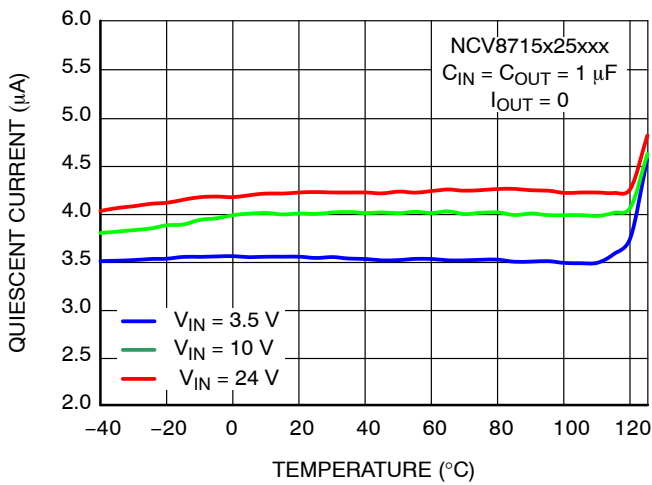

Figure 20. Quiescent Current vs. Temperature

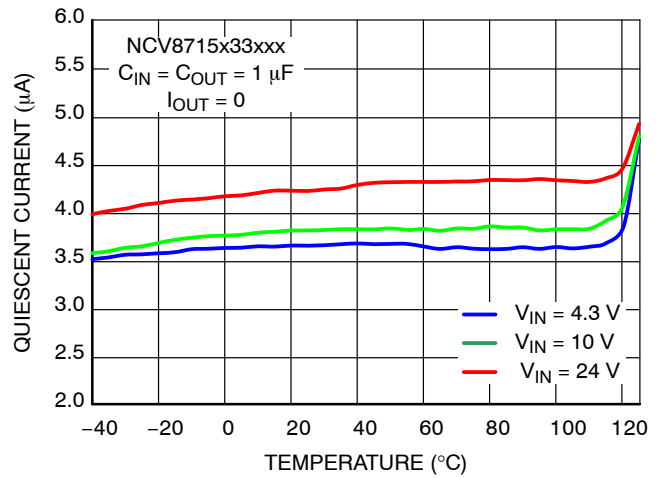

Figure 21. Quiescent Current vs. Temperature

NCV8715

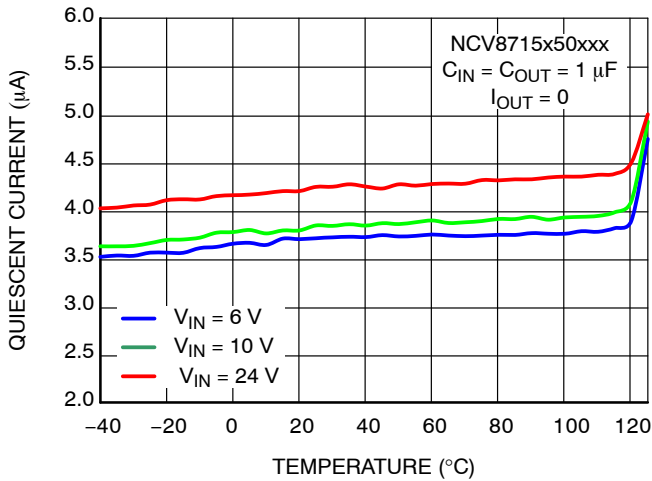

Figure 22. Quiescent Current vs. Temperature

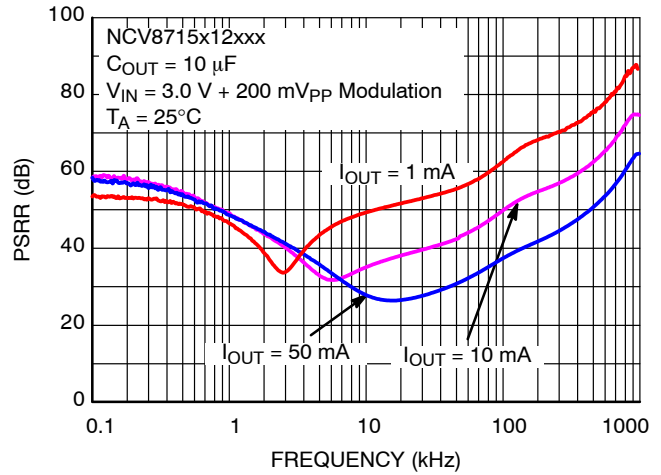

Figure 23. PSRR vs. Frequency

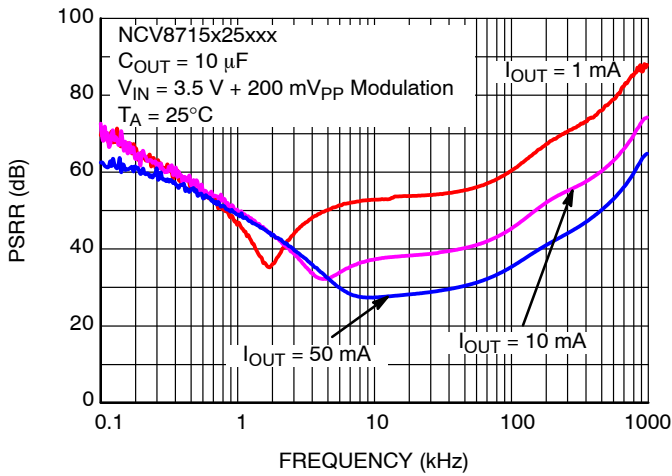

Figure 24. PSRR vs. Frequency

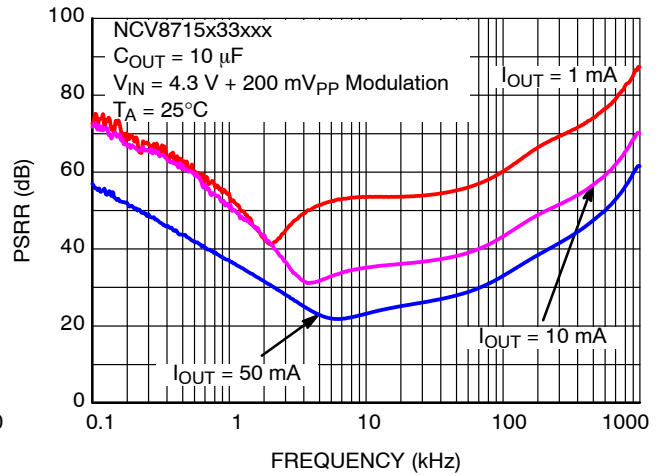

Figure 25. PSRR vs. Frequency

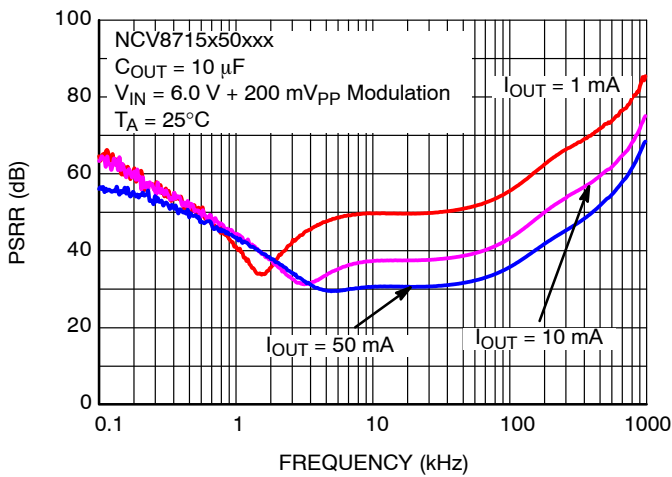

Figure 26. PSRR vs. Frequency

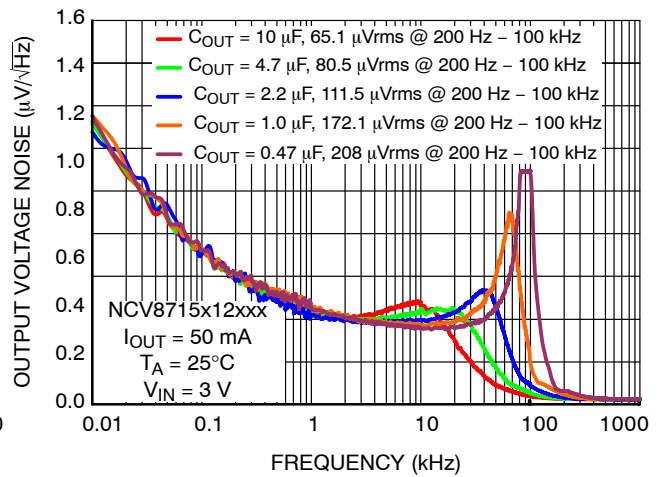

Figure 27. Output Spectral Noise Density vs. Frequency

NCV8715

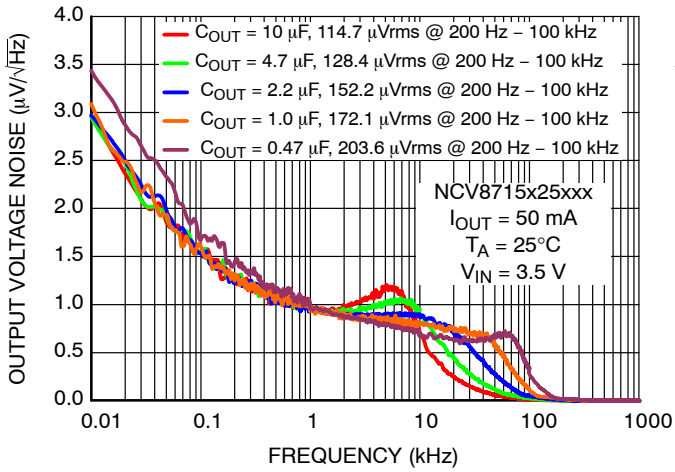

Figure 28. Output Spectral Noise Density vs. Frequency

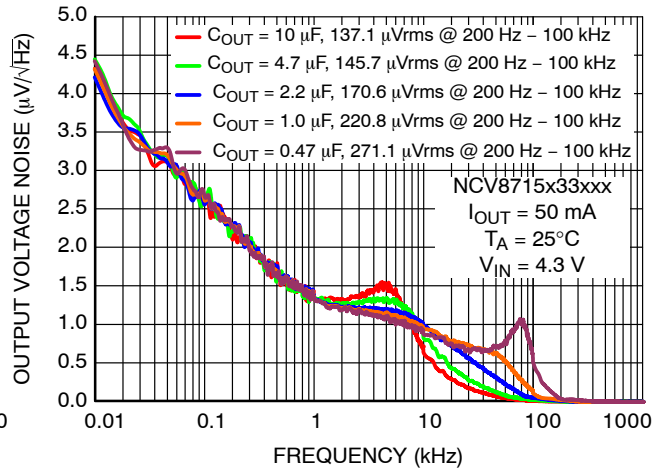

Figure 29. Output Spectral Noise Density vs. Frequency

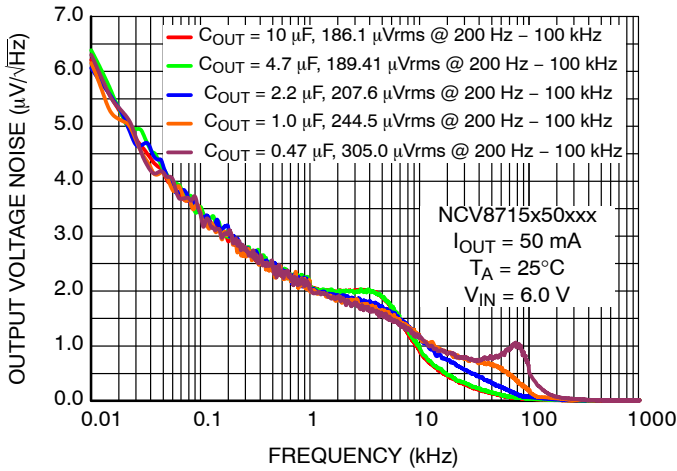

Figure 30. Output Spectral Noise Density vs. Frequency

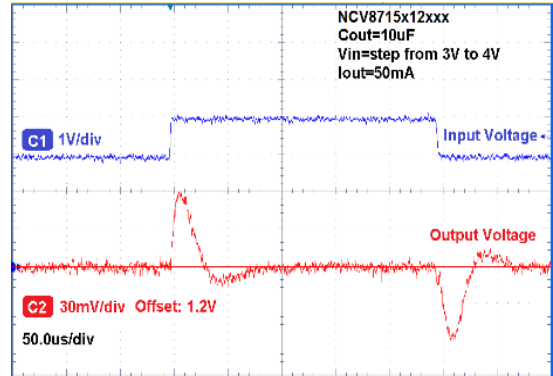

Figure 31. Line Transient Response

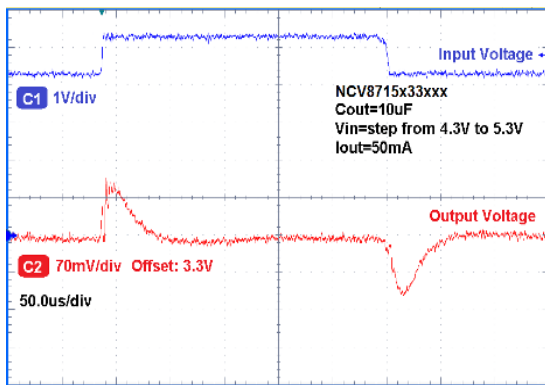

Figure 32. Line Transient Response

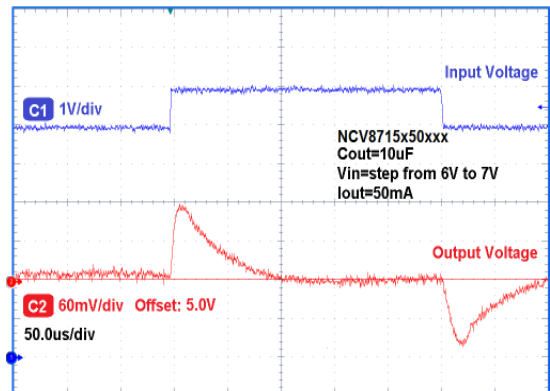

Figure 33. Line Transient Response

NCV8715

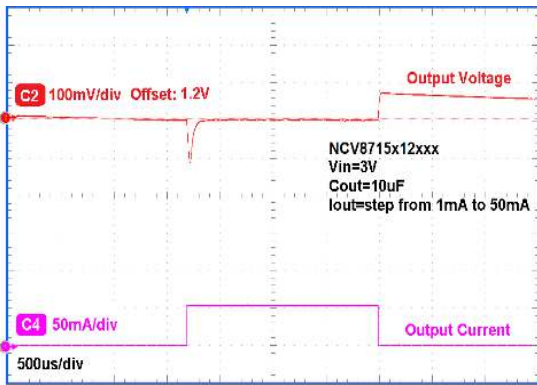

Figure 34. Load Transient Response

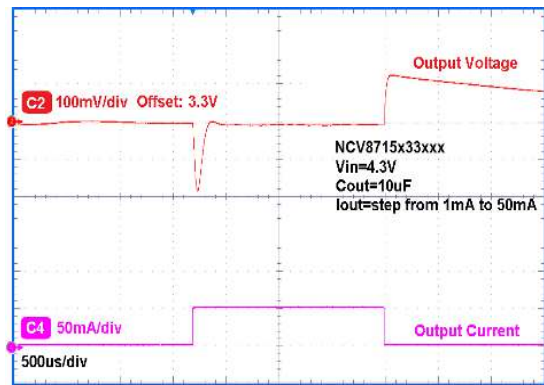

Figure 35. Load Transient Response

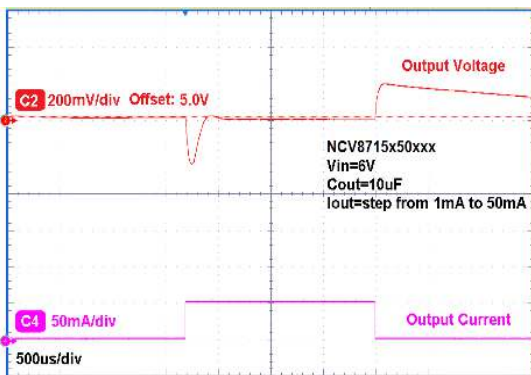

Figure 36. Load Transient Response

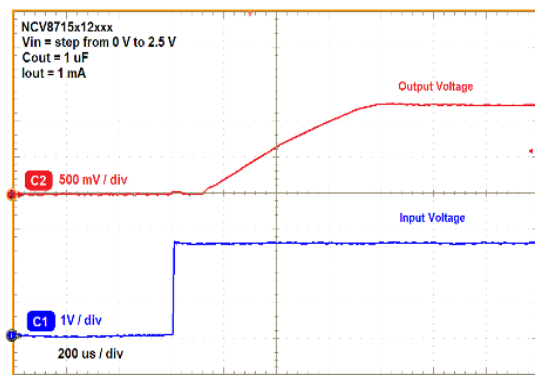

Figure 37. Input Voltage Turn-On Response

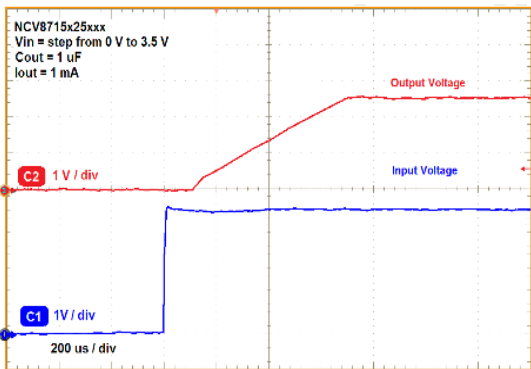

Figure 38. Input Voltage Turn-On Response

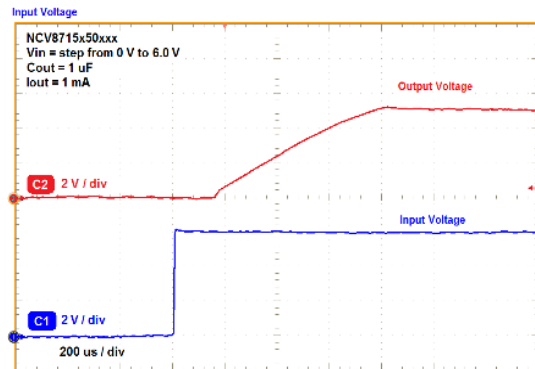

Figure 39. Input Voltage Turn-On Response

APPLICATIONS INFORMATION

The NCV8715 is the member of new family of Wide Input Voltage Range Low Dropout Regulators which delivers Ultra Low Ground Current consumption, Good Noise and Power Supply Rejection Ratio Performance.

Input Decoupling (C_{IN})

It is recommended to connect at least 0.1 µF Ceramic X5R or X7R capacitor between IN and GND pin of the device. This capacitor will provide a low impedance path for any unwanted AC signals or Noise superimposed onto constant Input Voltage. The good input capacitor will limit the influence of input trace inductances and source resistance during sudden load current changes.

Higher capacitance and lower ESR Capacitors will improve the overall line transient response.

Output Decoupling (C_{OUT})

The NCV8715 does not require a minimum Equivalent Series Resistance (ESR) for the output capacitor. The device is designed to be stable with standard ceramics capacitors with values of 0.47 µF or greater up to 10 µF. The X5R and X7R types have the lowest capacitance variations over temperature thus they are recommended.

Power Dissipation and Heat sinking

The maximum power dissipation supported by the device is dependent upon board design and layout. Mounting pad configuration on the PCB, the board material, and the

ambient temperature affect the rate of junction temperature rise for the part. The maximum power dissipation the NCV8715 can handle is given by:

$$P_{D(MAX)} = \frac{[T_{J(MAX)} - T_A]}{R_{\theta JA}} \quad (\text{eq. 1})$$

The power dissipated by the NCV8715 for given application conditions can be calculated from the following equations:

$$P_D \approx V_{IN}(I_{GND}(I_{OUT})) + I_{OUT}(V_{IN} - V_{OUT}) \quad (\text{eq. 2})$$

or

$$V_{IN(MAX)} \approx \frac{P_{D(MAX)} + (V_{OUT} \times I_{OUT})}{I_{OUT} + I_{GND}} \quad (\text{eq. 3})$$

For reliable operation, junction temperature should be limited to +125°C maximum.

Hints

V_{IN} and GND printed circuit board traces should be as wide as possible. When the impedance of these traces is high, there is a chance to pick up noise or cause the regulator to malfunction. Place external components, especially the output capacitor, as close as possible to the NCV8715, and make traces as short as possible.

NCV8715

ORDERING INFORMATION

| Device | Nominal Output Voltage | Marking | Package | Shipping [†] |
|--------------------------|------------------------|---------|----------------------------|---|
| NCV8715SQ12T2G | 1.2 V | V5A | SC-88A/SC-70 (Pb-Free)* | 3000 / Tape & Reel |
| NCV8715SQ15T2G | 1.5 V | V5C | | |
| NCV8715SQ18T2G | 1.8 V | V5D | | |
| NCV8715SQ21T2G | 2.1 V | V5J | | |
| NCV8715SQ25T2G | 2.5 V | V5E | | |
| NCV8715SQ30T2G | 3.0 V | V5F | | |
| NCV8715SQ33T2G | 3.3 V | V5G | | |
| NCV8715SQ50T2G | 5.0 V | V5H | | |
| NCV8715MX12TBG | 1.2 V | VA | XDFN6 (Pb-Free)* | 3000 or 5000 / Tape & Reel (Note 37) |
| NCV8715MX15TBG | 1.5 V | VC | | |
| NCV8715MX18TBG (Note 37) | 1.8 V | VE | | |
| NCV8715MX25TBG | 2.5 V | VE | | |
| NCV8715MX30TBG (Note 37) | 3.0 V | VF | | |
| NCV8715MX33TBG (Note 37) | 3.3 V | VG | | |
| NCV8715MX50TBG (Note 37) | 5.0 V | VH | | |

[†]For information on tape and reel specifications, including part orientation and tape sizes, please refer to our Tape and Reel Packaging Specifications Brochure, BRD8011/D.

*For additional information on our Pb-Free strategy and soldering details, please download the **onsemi** Soldering and Mounting Techniques Reference Manual, SOLDERRM/D.

37. Products processed after October 1, 2022 are shipped with quantity 5000 units / tape & reel.

MECHANICAL CASE OUTLINE PACKAGE DIMENSIONS



SCALE 2:1

SC-88A (SC-70-5/SOT-353) CASE 419A-02 ISSUE M

DATE 11 APR 2023

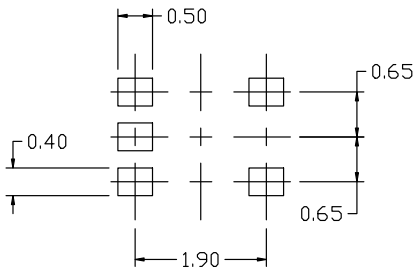
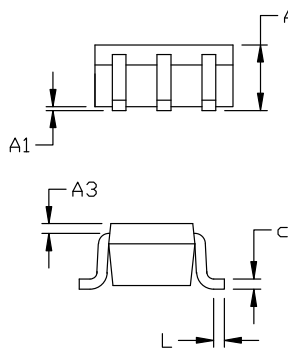
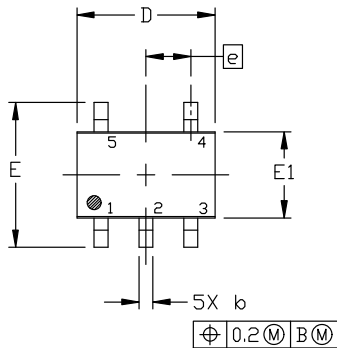

RECOMMENDED MOUNTING FOOTPRINT

* For additional information on our Pb-Free strategy and soldering details, please download the ON Semiconductor Soldering and Mounting Techniques Reference Manual, SOLDERM/D.

NOTES:

1. DIMENSIONING AND TOLERANCING PER ANSI Y14.5M, 1982.
2. CONTROLLING DIMENSION: MILLIMETERS
3. 419A-01 OBSOLETE. NEW STANDARD 419A-02
4. DIMENSIONS D AND E1 DO NOT INCLUDE MOLD FLASH, PROTRUSIONS, OR GATE BURRS. MOLD FLASH, PROTRUSIONS, OR GATE BURRS SHALL NOT EXCEED 0.1016MM PER SIDE.

| DIM | MILLIMETERS | | |
|-----|-------------|------|------|
| | MIN. | NOM. | MAX. |
| A | 0.80 | 0.95 | 1.10 |
| A1 | --- | --- | 0.10 |
| A3 | 0.20 REF | | |
| b | 0.10 | 0.20 | 0.30 |
| c | 0.10 | --- | 0.25 |
| D | 1.80 | 2.00 | 2.20 |
| E | 2.00 | 2.10 | 2.20 |
| E1 | 1.15 | 1.25 | 1.35 |
| e | 0.65 BSC | | |
| L | 0.10 | 0.15 | 0.30 |

GENERIC MARKING DIAGRAM*

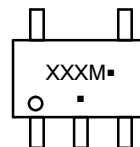

*This information is generic. Please refer to device data sheet for actual part marking. Pb-Free indicator, "G" or microdot "▪", may or may not be present. Some products may not follow the Generic Marking.

XXX = Specific Device Code

M = Date Code

▪ = Pb-Free Package

(Note: Microdot may be in either location)

STYLE 1:

1. BASE
2. EMITTER
3. BASE
4. COLLECTOR
5. COLLECTOR

STYLE 2:

1. ANODE
2. EMITTER
3. BASE
4. COLLECTOR
5. CATHODE

STYLE 3:

1. ANODE 1
2. N/C
3. ANODE 2
4. CATHODE 2
5. CATHODE 1

STYLE 4:

1. SOURCE 1
2. DRAIN 1/2
3. SOURCE 1
4. GATE 1
5. GATE 2

STYLE 5:

1. CATHODE
2. COMMON ANODE
3. CATHODE 2
4. CATHODE 3
5. CATHODE 4

STYLE 6:

1. EMITTER 2
2. BASE 2
3. EMITTER 1
4. COLLECTOR
5. COLLECTOR 2/BASE 1

STYLE 7:

1. BASE
2. EMITTER
3. BASE
4. COLLECTOR
5. COLLECTOR

STYLE 8:

1. CATHODE
2. COLLECTOR
3. N/C
4. BASE
5. EMITTER

STYLE 9:

1. ANODE
2. CATHODE
3. ANODE
4. ANODE
5. ANODE

Note: Please refer to datasheet for style callout. If style type is not called out in the datasheet refer to the device datasheet pinout or pin assignment.

| | | |
|-------------------------|---------------------------------|---|
| DOCUMENT NUMBER: | 98ASB42984B | Electronic versions are uncontrolled except when accessed directly from the Document Repository. Printed versions are uncontrolled except when stamped "CONTROLLED COPY" in red. |
| DESCRIPTION: | SC-88A (SC-70-5/SOT-353) | PAGE 1 OF 1 |

onsemi and ONSEMI are trademarks of Semiconductor Components Industries, LLC dba onsemi or its subsidiaries in the United States and/or other countries. onsemi reserves the right to make changes without further notice to any products herein. onsemi makes no warranty, representation or guarantee regarding the suitability of its products for any particular purpose, nor does onsemi assume any liability arising out of the application or use of any product or circuit, and specifically disclaims any and all liability, including without limitation special, consequential or incidental damages. onsemi does not convey any license under its patent rights nor the rights of others.

MECHANICAL CASE OUTLINE

PACKAGE DIMENSIONS

ON Semiconductor®



SCALE 4:1

XDFN6 1.5x1.5, 0.5P
CASE 711AE
ISSUE B

DATE 27 AUG 2015

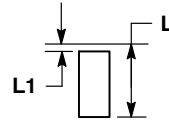
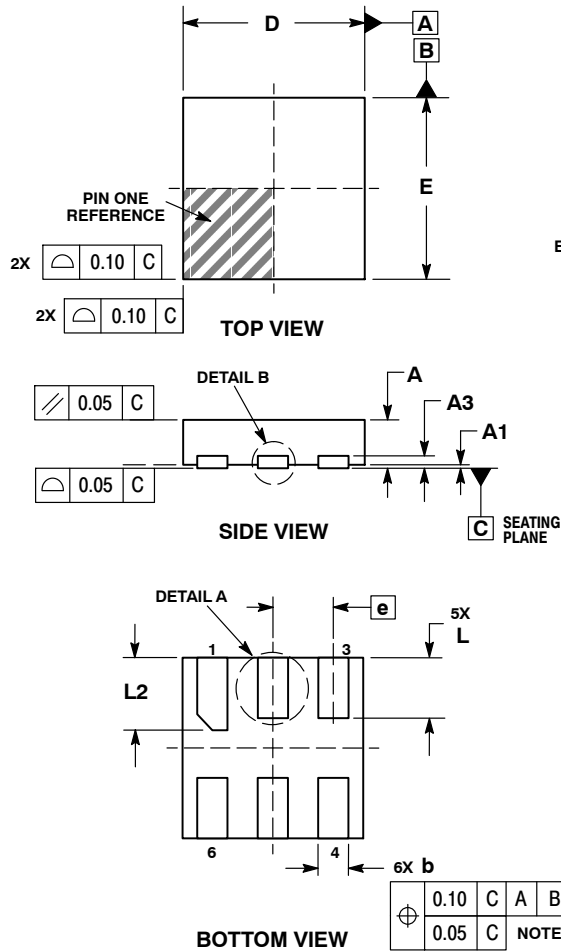

DETAIL A
ALTERNATE TERMINAL CONSTRUCTIONS

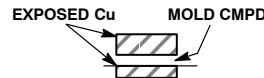

DETAIL B
ALTERNATE CONSTRUCTIONS

- NOTES:
- DIMENSIONING AND TOLERANCING PER ASME Y14.5M, 1994.
 - CONTROLLING DIMENSION: MILLIMETERS.
 - DIMENSION b APPLIES TO PLATED TERMINAL AND IS MEASURED BETWEEN 0.10 AND 0.20mm FROM TERMINAL TIP.

| DIM | MILLIMETERS | |
|-----|-------------|------|
| | MIN | MAX |
| A | 0.35 | 0.45 |
| A1 | 0.00 | 0.05 |
| A3 | 0.13 REF | |
| b | 0.20 | 0.30 |
| D | 1.50 BSC | |
| E | 1.50 BSC | |
| e | 0.50 BSC | |
| L | 0.40 | 0.60 |
| L1 | --- | 0.15 |
| L2 | 0.50 | 0.70 |

GENERIC MARKING DIAGRAM*

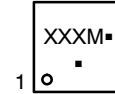

XXX = Specific Device Code

M = Date Code

▪ = Pb-Free Package

(Note: Microdot may be in either location)

*This information is generic. Please refer to device data sheet for actual part marking. Pb-Free indicator, "G" or microdot "▪", may or may not be present.

RECOMMENDED MOUNTING FOOTPRINT*

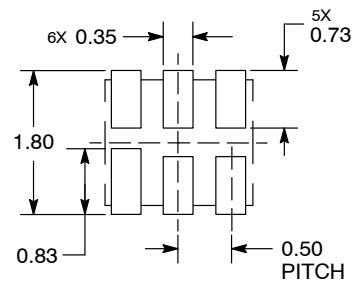

DIMENSIONS: MILLIMETERS

*For additional information on our Pb-Free strategy and soldering details, please download the ON Semiconductor Soldering and Mounting Techniques Reference Manual, SOLDERRM/D.

| | | |
|-------------------------|--------------------------------|--|
| DOCUMENT NUMBER: | 98AON56376E | Electronic versions are uncontrolled except when accessed directly from the Document Repository. Printed versions are uncontrolled except when stamped "CONTROLLED COPY" in red. |
| DESCRIPTION: | XDFN6, 1.5 X 1.5, 0.5 P | PAGE 1 OF 1 |

ON Semiconductor and are trademarks of Semiconductor Components Industries, LLC dba ON Semiconductor or its subsidiaries in the United States and/or other countries. ON Semiconductor reserves the right to make changes without further notice to any products herein. ON Semiconductor makes no warranty, representation or guarantee regarding the suitability of its products for any particular purpose, nor does ON Semiconductor assume any liability arising out of the application or use of any product or circuit, and specifically disclaims any and all liability, including without limitation special, consequential or incidental damages. ON Semiconductor does not convey any license under its patent rights nor the rights of others.

onsemi, **Onsemi**, and other names, marks, and brands are registered and/or common law trademarks of Semiconductor Components Industries, LLC dba "**onsemi**" or its affiliates and/or subsidiaries in the United States and/or other countries. **onsemi** owns the rights to a number of patents, trademarks, copyrights, trade secrets, and other intellectual property. A listing of **onsemi**'s product/patent coverage may be accessed at www.onsemi.com/site/pdf/Patent-Marking.pdf. **onsemi** reserves the right to make changes at any time to any products or information herein, without notice. The information herein is provided "as-is" and **onsemi** makes no warranty, representation or guarantee regarding the accuracy of the information, product features, availability, functionality, or suitability of its products for any particular purpose, nor does **onsemi** assume any liability arising out of the application or use of any product or circuit, and specifically disclaims any and all liability, including without limitation special, consequential or incidental damages. Buyer is responsible for its products and applications using **onsemi** products, including compliance with all laws, regulations and safety requirements or standards, regardless of any support or applications information provided by **onsemi**. "Typical" parameters which may be provided in **onsemi** data sheets and/or specifications can and do vary in different applications and actual performance may vary over time. All operating parameters, including "Typicals" must be validated for each customer application by customer's technical experts. **onsemi** does not convey any license under any of its intellectual property rights nor the rights of others. **onsemi** products are not designed, intended, or authorized for use as a critical component in life support systems or any FDA Class 3 medical devices or medical devices with a same or similar classification in a foreign jurisdiction or any devices intended for implantation in the human body. Should Buyer purchase or use **onsemi** products for any such unintended or unauthorized application, Buyer shall indemnify and hold **onsemi** and its officers, employees, subsidiaries, affiliates, and distributors harmless against all claims, costs, damages, and expenses, and reasonable attorney fees arising out of, directly or indirectly, any claim of personal injury or death associated with such unintended or unauthorized use, even if such claim alleges that **onsemi** was negligent regarding the design or manufacture of the part. **onsemi** is an Equal Opportunity/Affirmative Action Employer. This literature is subject to all applicable copyright laws and is not for resale in any manner.

ADDITIONAL INFORMATION

TECHNICAL PUBLICATIONS:

Technical Library: www.onsemi.com/design/resources/technical-documentation
onsemi Website: www.onsemi.com

ONLINE SUPPORT: www.onsemi.com/support

For additional information, please contact your local Sales Representative at www.onsemi.com/support/sales