

bq24230H and bq24232H 0.5-A Single-Chip Li-Ion

This user's guide describes the bq24230H (PREVIEW) and bq24232H (bqTINY-III™) evaluation module (EVM). The EVM provides a convenient method for evaluating the performance of a charge management and system power solution for portable applications having 4.35-V Li-Ion batteries using either the bq24230H and bq24232H products. A completely designed and tested module is presented. The charger is designed to deliver up to 0.5 A of continuous current to the system or charger for one-cell Li-ion or Li-polymer applications (see the data sheet for the correct device) using a DC power supply. The charger is programmed by the factory to deliver 0.5 A of charging current. This EVM was designed as a standalone evaluation module, but it can also be interfaced with the system and host via the connectors and headers.

Contents

1	Introduction	2
1.1	References	3
1.2	Schematic	3
2	Performance Specification Summary	3
2.1	Performance Recommendations	4
3	Test Summary	4
3.1	Equipment	4
3.2	Equipment and EVM Setup	4
3.3	Test Procedure	6
4	Physical Layouts	8
4.1	Board Layout	8
5	Bill of Materials	10

List of Figures

1	Test Diagram	5
2	Modes of Operation Tested in Steps 11 Through 13	7
3	Charge Enabled, Pulled High, Then Low – Disables Charge	7
4	Top Assembly View	8
5	Board Layout – Top Etch Layer	8
6	Board Layout – Bottom Etch Layer	9

List of Tables

1	Ordering Information	2
2	Performance Specification Summary for bq24230H and bq24232H EVMs	3
3	bq2423XHEVM Jumpers	4

1 Introduction

The bq2423xH family powers the system while independently charging the battery. This feature reduces the charge and discharge cycles on the battery, allows for proper charge termination, and allows the system to run with an absent or defective battery pack. This feature also allows for the system to instantaneously turn on from an external power source even when using a deeply discharged battery pack.

This charger family has one input and can be programmed to be used with an adapter or USB port as the power source for the system. In the USB configuration, the host can select from the two preset input maximum current limits of 100 and 500 mA. The charger dynamically adjusts the charge rate based on the system load to stay within the 100-mA or 500-mA maximum limits. An external resistor, RSET1, sets the magnitude of the charge current between 25 and 500 mA. If the charge current exceeds the available input current, the voltage on the OUT pin drops to the DPPM threshold or the battery voltage, whichever is higher. The charging current is reduced to what current is available ($I_{BAT} = I_{IN} - I_{OUT}$).

The integrated circuit (IC) charges the battery in three phases: conditioning, constant current, and constant voltage. Charge is terminated based on minimum current. A resistor-programmable charge timer provides a backup safety for charge termination. The charge automatically restarts if the battery voltage falls below an internal threshold. Sleep mode is entered when the supply is removed (V_{IN} drops to the battery voltage). Pin 15 of bq24230H has a TD pin that allows the user to disable termination (as well as safety timers) at startup. Pin 15 of the bq24232H is ITERM, which allows the user to set the termination up to 50% of the fast charge current instead of the default 10% value.

Table 1. Ordering Information

Part Number	V_{OVP}	V_{BAT}	$V_{OUT(REG)}$	V_{DPM}	Optional Function (PIN 15)	Marking
bq24230HRGTR (PREVIEW)	6.6 V	4.35 V	4.5 V	$V_{O(REG)} - 100 \text{ mV}$	TD	24230H
bq24232HRGTT	10.5 V	4.35 V	4.5 V	$V_{O(REG)} - 100 \text{ mV}$	ITERM	24232H

The two potential sources to power the system (V_{OUT}) are the input source and the battery (adapter or USB port). The IC is designed to power the system continuously. If the adapter or USB input is not available (or disabled), the battery connects to the system.

In the thermal regulation condition ($T_J = 125^\circ\text{C}$, not a first-choice design mode of operation), the charge current is reduced to the battery, and the system still gets its power from the input. The battery supplement is available in thermal regulation if the V_{OUT} falls to V_{BAT} . In thermal cutoff (approximately 155°C), the input sources are disconnected, but the internal battery FET connects the battery to V_{OUT} .

1.1 References

bq24230H and bq24232H data sheet, *USB-Friendly Li-Ion Battery Charger and Power-Path Management IC*, TI literature number [SLUS821](#)

1.2 Schematic

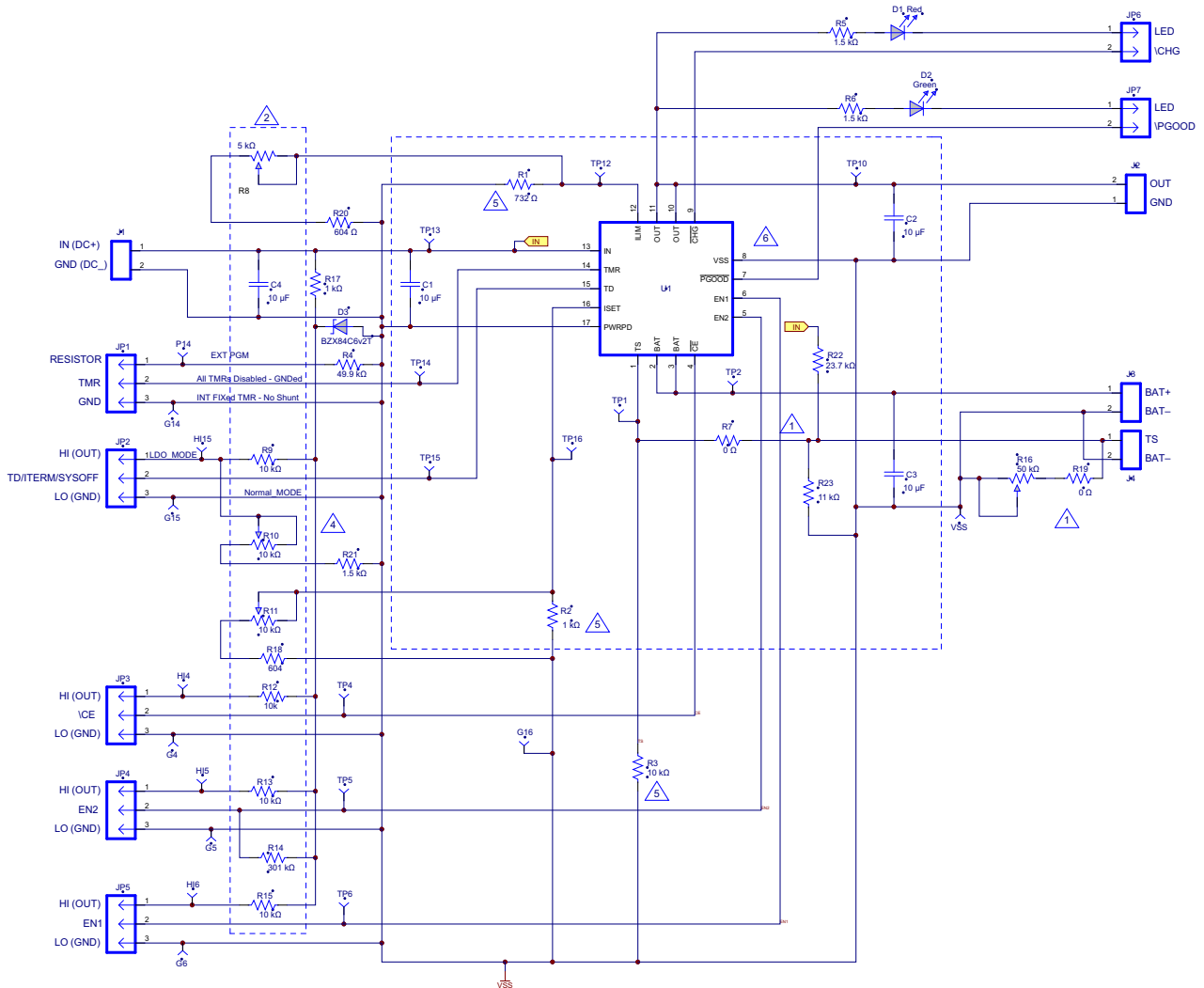

2 Performance Specification Summary

Table 2 summarizes the performance specifications of the EVM.

Table 2. Performance Specification Summary for bq24230H and bq24232H EVMs

SPECIFICATION	TEST CONDITIONS	MIN	TYP	MAX	UNIT
Input DC Voltage for bq24230H, V_{IN}		4.75	5	6.4	V
Input DC Voltage for bq24232H, V_{IN}		4.75	5	10.2	V
Battery Charge Current, I_{CHG}			250	500	mA
Power Dissipation, bq24230H and bq24232H IC, 1 Cell	$P_{diss} = (V_{IN} - V_{OUT}) I_{OUT} + (V_{IN} - V_{BAT}) I_{BAT}$			See ⁽¹⁾	W

⁽¹⁾ The PCB thermal design is optimized (8+ vias, 0.031-inch PCB, 2-oz. copper) to give $\theta_{JA} \approx 27^\circ\text{C/W}$.

2.1 Performance Recommendations

This IC is a linear battery charger and also powers the system from the input through the linear regulator output. Being a linear device, the charger is most efficient when the input voltage is only slightly above the battery voltage ($V_{IN} = 4.75$ to 5.5 V). Too low of an input voltage (less than the OUT voltage plus the dropout voltage) results in degraded performance. Excessive input voltage (> 5.5 V) results in excess power dissipation and reduced performance (that is, reduced charge current) due to the IC's thermal regulation protection circuit. The IC is rated to 28 V and is not damaged with V_{IN} voltages less than this, but any V_{IN} voltage over the overvoltage protection (OVP) threshold disables the IC. Thus, the recommended operating range for maximum performance is between 4.75 and 5.5 V, with a preference for the lower values.

3 Test Summary

This section covers the setup and tests performed in evaluating the EVM.

3.1 Equipment

- Power supply ($+5.25 \pm 0.25$ Vdc), current limit set to 1 A ± 0.1 A
- Three Fluke 75 DMMs (equivalent or better)
- Oscilloscope, model TDS220 (equivalent or better)

3.2 Equipment and EVM Setup

- Preset P/S number 1 to 5.25 V ± 0.25 V, 2 A ± 0.25 -A current limit, turn off, and connect to J1-IN/GND (+ to IN and – to GND)
- Connect a $10\text{-}\Omega$, $10\text{-}W$ resistor to J2-OUT/VSS
- Connect a fully discharged ($V_{BAT} < 2.8$ V) Battery to J3-BAT+/VSS (+ to BAT+ and – to VSS)
- Apply the jumpers as per [Table 3](#)
- For the bq2423xEVM, adjust the potentiometers as follows (measure resistance from TP number to VSS):
 - R8 (ILIM-TP12) = 3.1 k Ω (3.07 to 3.13 k Ω)
 - R11 (ISET-TP16) = 1.74 k Ω (1.72 to 1.75 k Ω)
 - R16 (TS-TP1) = 7.5 k Ω (7.3 to 7.7 k Ω)
 - For bq24074 (-006): R10 (ITERM-TP15) = 3 k Ω (2.98 to 3.02 k Ω)

Table 3. bq2423XEVM Jumpers

Jumper	bq24230H	bq24232H
JMP1	RES-TMR	RES-TMR
JMP2	TD-Vss	TD-Vss
JMP3	CE-Vss	CE-Vss
JMP4	EN2-HI	EN2-HI
JMP5	EN1-Vss	EN1-Vss

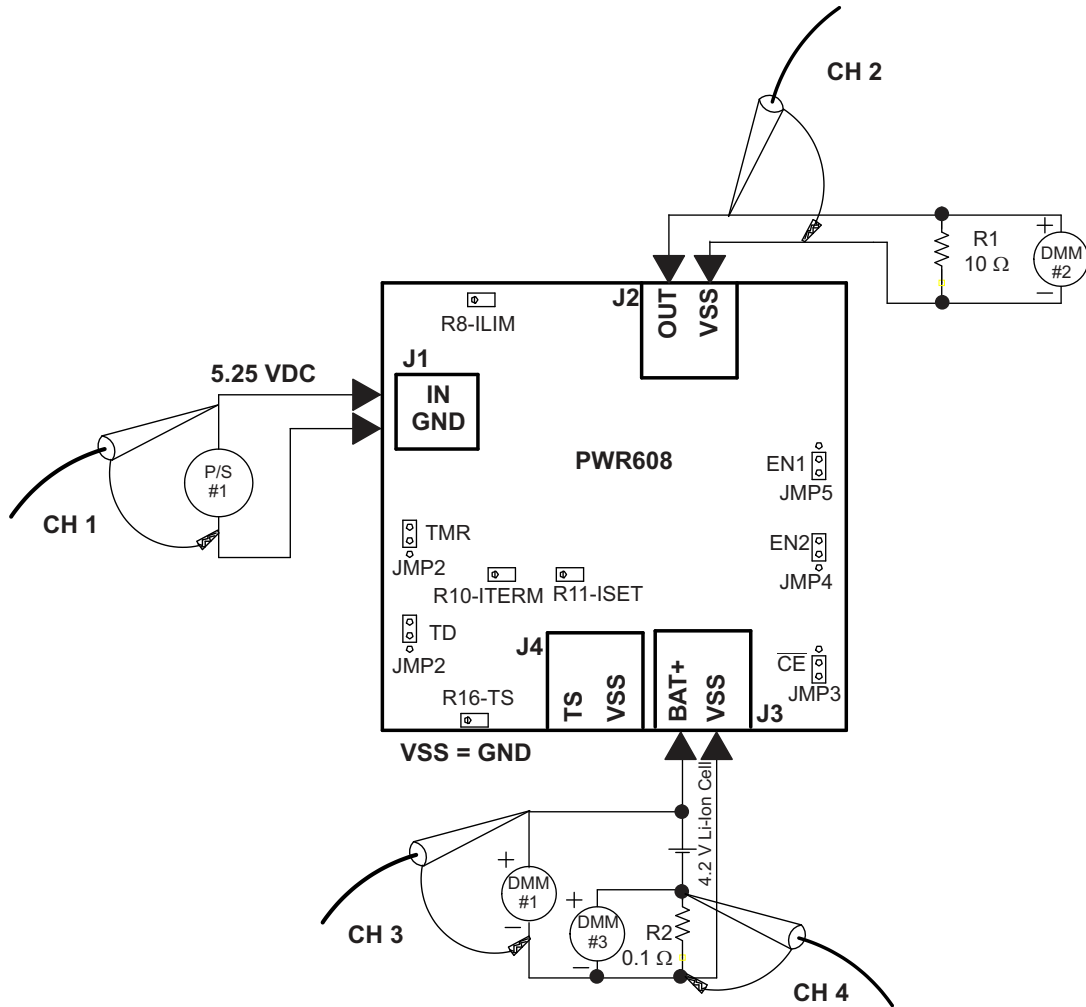

Figure 1. Test Diagram

3.3 Test Procedure

1. Verify that the equipment and EVM is setup according to the preceding section.
2. Verify that V_{OUT} is approximately equal to V_{BAT} .
3. Turn on P/S number 1, +5.25-Vdc supply to the UUT.
4. Verify V_{BAT} is between 2.4 and 3 Vdc, and the charger is in precharge state: LEDs CHG (D1) and PGOOD (D2) are on. If V_{BAT} is above the low-voltage threshold ($V_{(LOWV)}$ approximately 3 V), then the IC is in fast-charge mode. If the IC is in fast charge, skip step 7.
5. Verify DMM number 3, I_{BAT} is approximately 5 mV or approximately 0.05 A.
6. Verify that V_{OUT} for bq2423XH is 4.4 to 4.6 V.
7. Allow the battery to charge until V_{BAT} is between 3.3 and 4 Vdc. The charger delivers the programmed constant current to the battery unless the input cannot source the required current.
8. Verify I_{BAT} is approximately 50 mV or approximately 0.5 A (for a 1.74-k Ω resistor on *ISET*).
9. Set JMP5 (EN1) to HI, and verify that the chip is disabled, D1 (CHG) is turned off, and the P/S number 1 current has dropped to 0. The internal battery FET must be on, connecting the BAT pin to the OUT pin. Verify that the voltage on the OUT pin is close to the battery voltage. See [Figure 2](#) for EN1/2 modes of operation.
10. Set JMP4 (EN2) to VSS. Verify that the input current is less than 500 mA (USB 500-mA mode). If the input current is restricted due to USB mode, or if the adapter is current limiting, the OUT pin drops in voltage and enters the DPM mode, if the system current is less than the restricted input current. This IC must be in DPM mode with the system voltage at the DPM.
11. Set JMP5 (EN1) to VSS and verify USB 100-mA mode. The system load is more than the allowed 100 mA on the input, so the OUT voltage drops to the battery voltage, and the battery FET is switched on and supplements the input current. Verify that V_{OUT} has dropped just below the battery voltage and the battery is supplying I_{BAT} , approximately ($V_{OUT} / 10 \Omega - 100 \text{ mA}$).
12. Set JMP4 (EN2) to HI to return to the ISET mode where the programmed current is approximately 0.5 A.
13. Set JMP3 to HI, and verify that the charging is disabled and that the CHG LED (D1) turns off. Verify that the system is still powered by the input.
14. Set JMP3 to VSS, and verify that charging continues and that D1 turns on.
15. Record the OUT voltage and battery charge current. Adjust R8 CCW until the input current starts to be reduced (about 2 turns). Note how the OUT voltage drops and the charge current is reduced as the input current limit loops kicks in and limits the input current. Adjust R8 to its original position.
16. On the bq24230H IC, set JMP2 HI, and verify that the BAT FET turns off and allows no charging or discharging of the battery.
17. Adjust the R16 (TS-Pot) up or down until the TS threshold is reached. Verify that the charging current is disabled. Return the TS resistance within the normal range and verify the continued charging operation.
18. Allow the battery to continue to charge until the battery reaches voltage regulation, approximately 4.2 V \pm 40 mV. Verify that the voltage is regulated as the current tapers over the next 1 to 2 h depending on the battery capacity. See [Figure 3](#) for a charge profile (time in plot is not proportional to actual charge time).
19. Verify that the current tapers to about 50 mA (5 mV on DMM number 3) when termination occurs. Note on the bq24230H IC that termination can be disabled by setting the TD pin HI (JMP2). Also note that on bq24232H, the ITERM resistor (R10) can adjust the termination threshold.
20. Verify that the LED, D1, turns off and the current drops to 0.
21. Turn off P/S number 1, and allow the system load to discharge the battery until a refresh charge is initiated. Verify that the battery voltage dropped to approximately 4.1 V.
22. Verify that the LED, D1, did not turn on for the refresh cycle.

This concludes the procedure for demonstrating the features of this power path charger. For more detailed explanations and instructive waveforms, see the [data sheet](#).

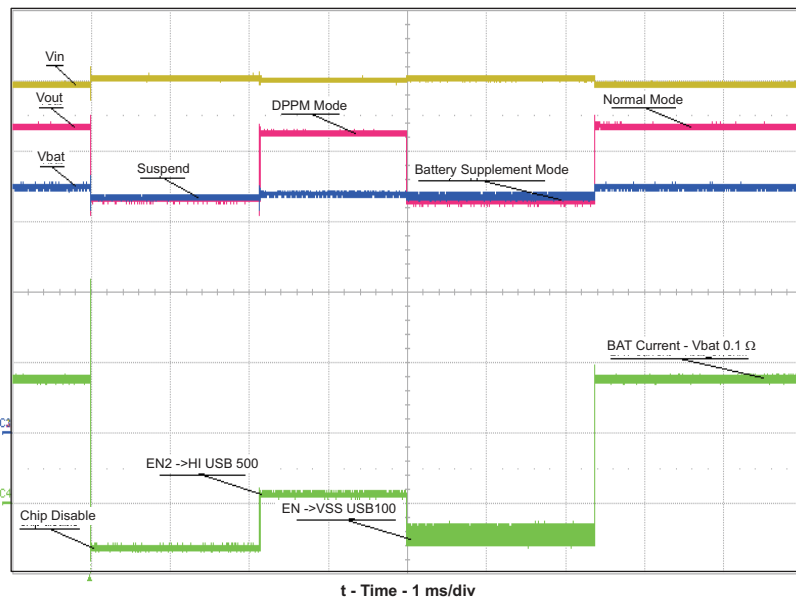

Figure 2. Modes of Operation Tested in Steps 11 Through 13

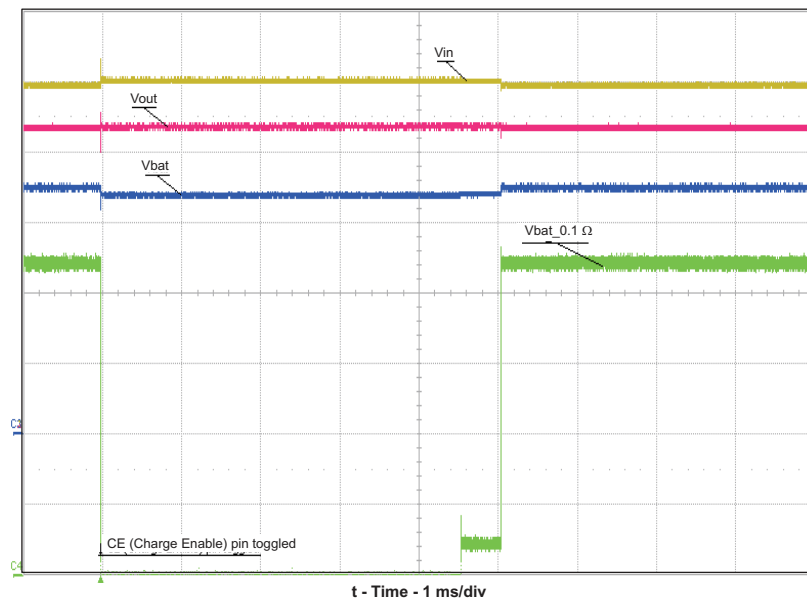

Figure 3. Charge Enabled, Pulled High, Then Low – Disables Charge

4 Physical Layouts

This section contains the board layout and assembly drawings for the EVM.

4.1 Board Layout

Figure 4 shows the top assembly view of the EVM. Figure 5 shows the top etch layer of the EVM, and Figure 6 shows the bottom etch layer.

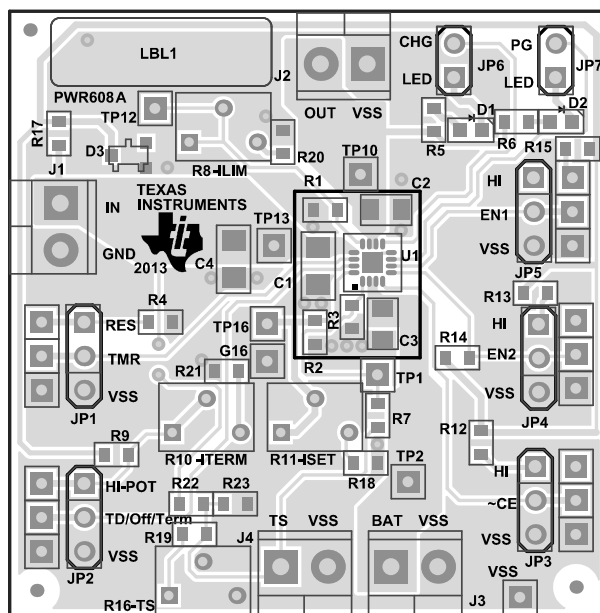

Figure 4. Top Assembly View

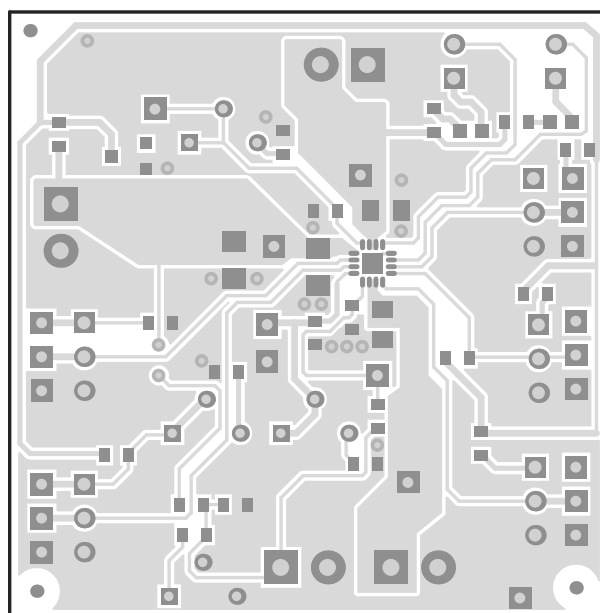

Figure 5. Board Layout – Top Etch Layer

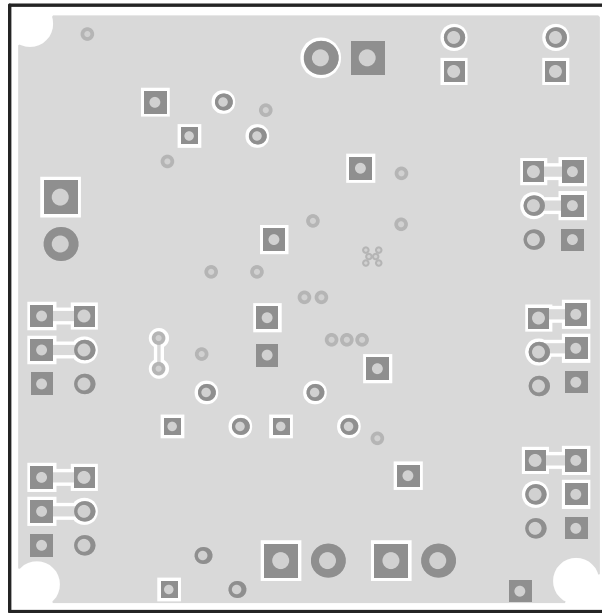

Figure 6. Board Layout – Bottom Etch Layer

5 Bill of Materials

Designator	Quantity	Value	Description	Package Reference	Part Number	Manufacturer	Alternate Part Number	Alternate Manufacturer
IPCB	1		Printed Circuit Board		PWR608	Any	-	-
C1, C4	2	10uF	CAP CER 10UF 25V 20% X5R 1206	1206	C3216X5R1E106M085AC	TDK		
C2, C3	2	10uF	Capacitor, Ceramic, 10-uF, 6.3-V, X5R, 20%	0805	GRM21BR60J106ME19K	Murata		
D1	1	Red	Diode, LED, Red, 1.8-V, 10-mA, 10-mcd	0603	160-1181-1-ND	Liteon		
D2	1	Green	Diode, LED, Green, 2.1-V, 20-mA, 6-mcd	0603	160-1183-1-ND	Liteon		
D3	1	BZX84C6v2T	Diode, Zener, 6.2-V, 350-mW	SOT-23	BZX84C6V2-7-F	Diodes		
J1, J2, J3, J4	4	ED555/2DS	Terminal Block, 2-pin, 6-A, 3.5mm	0.27 x 0.25	ED1514	OST		
JP1, JP2, JP3, JP4, JP5	5	PEC03SAAN	Header, 3-pin, 100mil spacing	0.100 x 3	PEC03SAAN	Sullins		
JP6, JP7	2	PEC02SAAN	Header, 2-pin, 100mil spacing	0.100 inch x 2	PEC02SAAN	Sullins		
LBL1	1		Thermal Transfer Printable Labels, 0.650" W x 0.200" H - 10,000 per roll	PCB Label 0.650"H x 0.200"W	THT-14-423-10	Brady	-	-
P14, VSS	2		Test Point, 0.032 Hole		Void	None		
R4	1	49.9k	Resistor, Chip, 1/10W, 1%	0603	CRCW060349K9FKEA	Vishay Dale		
R5, R6, R21	3	1.5K	Resistor, Chip, 1/10W, 1%	0603	CRCW06031K50FKEA	Vishay Dale		
R7, R19	2	0	Resistor, Chip, 1/10W, 1%	0603	CRCW06030000Z0EA	Vishay Dale		
R8	1	5K	Potentiometer, 1/4 in. Cermet, 12-Turn, Top-Adjust	0.25x0.17 inch	3266W-1-502LF	Bourns		
R10, R11	2	10k	Potentiometer, 1/4 in. Cermet, 12-Turn, Top-Adjust	0.25x0.17	3266W-1-103LF	Bourns		
R12, R13, R15	3	10k	Resistor, Chip, 1/10W, 1%	0603	CRCW060310K0FKEA	Vishay Dale		
R14	1	301k	Resistor, Chip, 1/10W, 1%	0603	CRCW0603301KFKEA	Vishay Dale		
R16	1	50k	Potentiometer, 1/4 in. Cermet, 12-Turn, Top-Adjust	0.25x0.17	3266W-1-503LF	Bourns		
R17	1	1k	Resistor, Chip, 1/10W, 1%	0603	CRCW06031K00FKEA	Vishay Dale		
R18, R20	2	604	Resistor, Chip, 1/10W, 1%	0603	CRCW0603604RFKEA	Vishay Dale		
SH-JP1, SH-JP2, SH-JP3, SH-JP4, SH-JP5, SH-JP6, SH-JP7	7	1x2	Shunt, 100mil, Gold plated, Black	Shunt	969102-0000-DA	3M	SNT-100-BK-G	Samtec
U1	1	BQ24232HRGE	IC, USB- Friendly Lilon Battery Charger and Power-Path Management	QFN-16	BQ24232HRGE	TI		None

Designator	Quantity	Value	Description	Package Reference	Part Number	Manufacturer	Alternate Part Number	Alternate Manufacturer
FID1, FID2, FID3	0		Fiducial mark. There is nothing to buy or mount.	Fiducial	N/A	N/A		
G4, G5, G6, G14, G15, G16, HI4, HI5, HI6, HI15, TP1, TP2, TP4, TP5, TP6, TP10, TP12, TP13, TP14, TP15, TP16	0		Test Point, 0.032 Hole		Void	None		
R1	0	732	Resistor, Chip, 1/10W, 1%	0603	CRCW0603732RFKEA	Vishay Dale		
R2	0	1k	Resistor, Chip, 1/10W, 1%	0603	CRCW06031K00FKEA	Vishay Dale		
R3, R9	0	10k	Resistor, Chip, 1/10W, 1%	0603	CRCW060310K0FKEA	Vishay Dale		
R22	0	23.7k	Resistor, Chip, 1/10W, 1%	0603	CRCW060323K7FKEA	Vishay Dale		
R23	0	11k	Resistor, Chip, 1/10W, 1%	0603	CRCW060311K0FKEA	Vishay Dale		

EVALUATION BOARD/KIT/MODULE (EVM) ADDITIONAL TERMS

Texas Instruments (TI) provides the enclosed Evaluation Board/Kit/Module (EVM) under the following conditions:

The user assumes all responsibility and liability for proper and safe handling of the goods. Further, the user indemnifies TI from all claims arising from the handling or use of the goods.

Should this evaluation board/kit not meet the specifications indicated in the User's Guide, the board/kit may be returned within 30 days from the date of delivery for a full refund. THE FOREGOING LIMITED WARRANTY IS THE EXCLUSIVE WARRANTY MADE BY SELLER TO BUYER AND IS IN LIEU OF ALL OTHER WARRANTIES, EXPRESSED, IMPLIED, OR STATUTORY, INCLUDING ANY WARRANTY OF MERCHANTABILITY OR FITNESS FOR ANY PARTICULAR PURPOSE. EXCEPT TO THE EXTENT OF THE INDEMNITY SET FORTH ABOVE, NEITHER PARTY SHALL BE LIABLE TO THE OTHER FOR ANY INDIRECT, SPECIAL, INCIDENTAL, OR CONSEQUENTIAL DAMAGES.

Please read the User's Guide and, specifically, the Warnings and Restrictions notice in the User's Guide prior to handling the product. This notice contains important safety information about temperatures and voltages. For additional information on TI's environmental and/or safety programs, please visit www.ti.com/esh or contact TI.

No license is granted under any patent right or other intellectual property right of TI covering or relating to any machine, process, or combination in which such TI products or services might be or are used. TI currently deals with a variety of customers for products, and therefore our arrangement with the user is not exclusive. TI assumes no liability for applications assistance, customer product design, software performance, or infringement of patents or services described herein.

REGULATORY COMPLIANCE INFORMATION

As noted in the EVM User's Guide and/or EVM itself, this EVM and/or accompanying hardware may or may not be subject to the Federal Communications Commission (FCC) and Industry Canada (IC) rules.

For EVMs **not** subject to the above rules, this evaluation board/kit/module is intended for use for ENGINEERING DEVELOPMENT, DEMONSTRATION OR EVALUATION PURPOSES ONLY and is not considered by TI to be a finished end product fit for general consumer use. It generates, uses, and can radiate radio frequency energy and has not been tested for compliance with the limits of computing devices pursuant to part 15 of FCC or ICES-003 rules, which are designed to provide reasonable protection against radio frequency interference. Operation of the equipment may cause interference with radio communications, in which case the user at his own expense will be required to take whatever measures may be required to correct this interference.

General Statement for EVMs including a radio

User Power/Frequency Use Obligations: This radio is intended for development/professional use only in legally allocated frequency and power limits. Any use of radio frequencies and/or power availability of this EVM and its development application(s) must comply with local laws governing radio spectrum allocation and power limits for this evaluation module. It is the user's sole responsibility to only operate this radio in legally acceptable frequency space and within legally mandated power limitations. Any exceptions to this are strictly prohibited and unauthorized by Texas Instruments unless user has obtained appropriate experimental/development licenses from local regulatory authorities, which is responsibility of user including its acceptable authorization.

For EVMs annotated as FCC – FEDERAL COMMUNICATIONS COMMISSION Part 15 Compliant

Caution

This device complies with part 15 of the FCC Rules. Operation is subject to the following two conditions: (1) This device may not cause harmful interference, and (2) this device must accept any interference received, including interference that may cause undesired operation.

Changes or modifications not expressly approved by the party responsible for compliance could void the user's authority to operate the equipment.

FCC Interference Statement for Class A EVM devices

This equipment has been tested and found to comply with the limits for a Class A digital device, pursuant to part 15 of the FCC Rules. These limits are designed to provide reasonable protection against harmful interference when the equipment is operated in a commercial environment. This equipment generates, uses, and can radiate radio frequency energy and, if not installed and used in accordance with the instruction manual, may cause harmful interference to radio communications. Operation of this equipment in a residential area is likely to cause harmful interference in which case the user will be required to correct the interference at his own expense.

FCC Interference Statement for Class B EVM devices

This equipment has been tested and found to comply with the limits for a Class B digital device, pursuant to part 15 of the FCC Rules. These limits are designed to provide reasonable protection against harmful interference in a residential installation. This equipment generates, uses and can radiate radio frequency energy and, if not installed and used in accordance with the instructions, may cause harmful interference to radio communications. However, there is no guarantee that interference will not occur in a particular installation. If this equipment does cause harmful interference to radio or television reception, which can be determined by turning the equipment off and on, the user is encouraged to try to correct the interference by one or more of the following measures:

- Reorient or relocate the receiving antenna.
- Increase the separation between the equipment and receiver.
- Connect the equipment into an outlet on a circuit different from that to which the receiver is connected.
- Consult the dealer or an experienced radio/TV technician for help.

For EVMs annotated as IC – INDUSTRY CANADA Compliant

This Class A or B digital apparatus complies with Canadian ICES-003.

Changes or modifications not expressly approved by the party responsible for compliance could void the user's authority to operate the equipment.

Concerning EVMs including radio transmitters

This device complies with Industry Canada licence-exempt RSS standard(s). Operation is subject to the following two conditions: (1) this device may not cause interference, and (2) this device must accept any interference, including interference that may cause undesired operation of the device.

Concerning EVMs including detachable antennas

Under Industry Canada regulations, this radio transmitter may only operate using an antenna of a type and maximum (or lesser) gain approved for the transmitter by Industry Canada. To reduce potential radio interference to other users, the antenna type and its gain should be so chosen that the equivalent isotropically radiated power (e.i.r.p.) is not more than that necessary for successful communication.

This radio transmitter has been approved by Industry Canada to operate with the antenna types listed in the user guide with the maximum permissible gain and required antenna impedance for each antenna type indicated. Antenna types not included in this list, having a gain greater than the maximum gain indicated for that type, are strictly prohibited for use with this device.

Cet appareil numérique de la classe A ou B est conforme à la norme NMB-003 du Canada.

Les changements ou les modifications pas expressément approuvés par la partie responsable de la conformité ont pu vider l'autorité de l'utilisateur pour actionner l'équipement.

Concernant les EVMs avec appareils radio

Le présent appareil est conforme aux CNR d'Industrie Canada applicables aux appareils radio exempts de licence. L'exploitation est autorisée aux deux conditions suivantes : (1) l'appareil ne doit pas produire de brouillage, et (2) l'utilisateur de l'appareil doit accepter tout brouillage radioélectrique subi, même si le brouillage est susceptible d'en compromettre le fonctionnement.

Concernant les EVMs avec antennes détachables

Conformément à la réglementation d'Industrie Canada, le présent émetteur radio peut fonctionner avec une antenne d'un type et d'un gain maximal (ou inférieur) approuvé pour l'émetteur par Industrie Canada. Dans le but de réduire les risques de brouillage radioélectrique à l'intention des autres utilisateurs, il faut choisir le type d'antenne et son gain de sorte que la puissance isotrope rayonnée équivalente (p.i.r.e.) ne dépasse pas l'intensité nécessaire à l'établissement d'une communication satisfaisante.

Le présent émetteur radio a été approuvé par Industrie Canada pour fonctionner avec les types d'antenne énumérés dans le manuel d'usage et ayant un gain admissible maximal et l'impédance requise pour chaque type d'antenne. Les types d'antenne non inclus dans cette liste, ou dont le gain est supérieur au gain maximal indiqué, sont strictement interdits pour l'exploitation de l'émetteur.

【Important Notice for Users of EVMs for RF Products in Japan】

This development kit is NOT certified as Confirming to Technical Regulations of Radio Law of Japan

If you use this product in Japan, you are required by Radio Law of Japan to follow the instructions below with respect to this product:

1. Use this product in a shielded room or any other test facility as defined in the notification #173 issued by Ministry of Internal Affairs and Communications on March 28, 2006, based on Sub-section 1.1 of Article 6 of the Ministry's Rule for Enforcement of Radio Law of Japan,
2. Use this product only after you obtained the license of Test Radio Station as provided in Radio Law of Japan with respect to this product, or
3. Use of this product only after you obtained the Technical Regulations Conformity Certification as provided in Radio Law of Japan with respect to this product. Also, please do not transfer this product, unless you give the same notice above to the transferee. Please note that if you could not follow the instructions above, you will be subject to penalties of Radio Law of Japan.

Texas Instruments Japan Limited
(address) 24-1, Nishi-Shinjuku 6 chome, Shinjuku-ku, Tokyo, Japan

<http://www.tij.co.jp>

【無線電波を送信する製品の開発キットをお使いになる際の注意事項】

本開発キットは技術基準適合証明を受けておりません。

本製品のご使用に際しては、電波法遵守のため、以下のいずれかの措置を取っていただく必要がありますのでご注意ください。

1. 電波法施行規則第6条第1項第1号に基づく平成18年3月28日総務省告示第173号で定められた電波暗室等の試験設備でご使用いただく。
2. 実験局の免許を取得後ご使用いただく。
3. 技術基準適合証明を取得後ご使用いただく。

なお、本製品は、上記の「ご使用にあたっての注意」を譲渡先、移転先に通知しない限り、譲渡、移転できないものとします。

上記を遵守頂けない場合は、電波法の罰則が適用される可能性があることをご留意ください。

日本テキサス・インスツルメンツ株式会社

東京都新宿区西新宿 6 丁目 2 4 番 1 号

西新宿三井ビル

<http://www.tij.co.jp>

EVALUATION BOARD/KIT/MODULE (EVM) WARNINGS, RESTRICTIONS AND DISCLAIMERS

For Feasibility Evaluation Only, in Laboratory/Development Environments. Unless otherwise indicated, this EVM is not a finished electrical equipment and not intended for consumer use. It is intended solely for use for preliminary feasibility evaluation in laboratory/development environments by technically qualified electronics experts who are familiar with the dangers and application risks associated with handling electrical mechanical components, systems and subsystems. It should not be used as all or part of a finished end product.

Your Sole Responsibility and Risk. You acknowledge, represent and agree that:

1. You have unique knowledge concerning Federal, State and local regulatory requirements (including but not limited to Food and Drug Administration regulations, if applicable) which relate to your products and which relate to your use (and/or that of your employees, affiliates, contractors or designees) of the EVM for evaluation, testing and other purposes.
2. You have full and exclusive responsibility to assure the safety and compliance of your products with all such laws and other applicable regulatory requirements, and also to assure the safety of any activities to be conducted by you and/or your employees, affiliates, contractors or designees, using the EVM. Further, you are responsible to assure that any interfaces (electronic and/or mechanical) between the EVM and any human body are designed with suitable isolation and means to safely limit accessible leakage currents to minimize the risk of electrical shock hazard.
3. Since the EVM is not a completed product, it may not meet all applicable regulatory and safety compliance standards (such as UL, CSA, VDE, CE, RoHS and WEEE) which may normally be associated with similar items. You assume full responsibility to determine and/or assure compliance with any such standards and related certifications as may be applicable. You will employ reasonable safeguards to ensure that your use of the EVM will not result in any property damage, injury or death, even if the EVM should fail to perform as described or expected.
4. You will take care of proper disposal and recycling of the EVM's electronic components and packing materials.

Certain Instructions. It is important to operate this EVM within TI's recommended specifications and environmental considerations per the user guidelines. Exceeding the specified EVM ratings (including but not limited to input and output voltage, current, power, and environmental ranges) may cause property damage, personal injury or death. If there are questions concerning these ratings please contact a TI field representative prior to connecting interface electronics including input power and intended loads. Any loads applied outside of the specified output range may result in unintended and/or inaccurate operation and/or possible permanent damage to the EVM and/or interface electronics. Please consult the EVM User's Guide prior to connecting any load to the EVM output. If there is uncertainty as to the load specification, please contact a TI field representative. During normal operation, some circuit components may have case temperatures greater than 60°C as long as the input and output are maintained at a normal ambient operating temperature. These components include but are not limited to linear regulators, switching transistors, pass transistors, and current sense resistors which can be identified using the EVM schematic located in the EVM User's Guide. When placing measurement probes near these devices during normal operation, please be aware that these devices may be very warm to the touch. As with all electronic evaluation tools, only qualified personnel knowledgeable in electronic measurement and diagnostics normally found in development environments should use these EVMs.

Agreement to Defend, Indemnify and Hold Harmless. You agree to defend, indemnify and hold TI, its licensors and their representatives harmless from and against any and all claims, damages, losses, expenses, costs and liabilities (collectively, "Claims") arising out of or in connection with any use of the EVM that is not in accordance with the terms of the agreement. This obligation shall apply whether Claims arise under law of tort or contract or any other legal theory, and even if the EVM fails to perform as described or expected.

Safety-Critical or Life-Critical Applications. If you intend to evaluate the components for possible use in safety critical applications (such as life support) where a failure of the TI product would reasonably be expected to cause severe personal injury or death, such as devices which are classified as FDA Class III or similar classification, then you must specifically notify TI of such intent and enter into a separate Assurance and Indemnity Agreement.

Mailing Address: Texas Instruments, Post Office Box 655303, Dallas, Texas 75265
Copyright © 2014, Texas Instruments Incorporated

IMPORTANT NOTICE

Texas Instruments Incorporated and its subsidiaries (TI) reserve the right to make corrections, enhancements, improvements and other changes to its semiconductor products and services per JESD46, latest issue, and to discontinue any product or service per JESD48, latest issue. Buyers should obtain the latest relevant information before placing orders and should verify that such information is current and complete. All semiconductor products (also referred to herein as "components") are sold subject to TI's terms and conditions of sale supplied at the time of order acknowledgment.

TI warrants performance of its components to the specifications applicable at the time of sale, in accordance with the warranty in TI's terms and conditions of sale of semiconductor products. Testing and other quality control techniques are used to the extent TI deems necessary to support this warranty. Except where mandated by applicable law, testing of all parameters of each component is not necessarily performed.

TI assumes no liability for applications assistance or the design of Buyers' products. Buyers are responsible for their products and applications using TI components. To minimize the risks associated with Buyers' products and applications, Buyers should provide adequate design and operating safeguards.

TI does not warrant or represent that any license, either express or implied, is granted under any patent right, copyright, mask work right, or other intellectual property right relating to any combination, machine, or process in which TI components or services are used. Information published by TI regarding third-party products or services does not constitute a license to use such products or services or a warranty or endorsement thereof. Use of such information may require a license from a third party under the patents or other intellectual property of the third party, or a license from TI under the patents or other intellectual property of TI.

Reproduction of significant portions of TI information in TI data books or data sheets is permissible only if reproduction is without alteration and is accompanied by all associated warranties, conditions, limitations, and notices. TI is not responsible or liable for such altered documentation. Information of third parties may be subject to additional restrictions.

Resale of TI components or services with statements different from or beyond the parameters stated by TI for that component or service voids all express and any implied warranties for the associated TI component or service and is an unfair and deceptive business practice. TI is not responsible or liable for any such statements.

Buyer acknowledges and agrees that it is solely responsible for compliance with all legal, regulatory and safety-related requirements concerning its products, and any use of TI components in its applications, notwithstanding any applications-related information or support that may be provided by TI. Buyer represents and agrees that it has all the necessary expertise to create and implement safeguards which anticipate dangerous consequences of failures, monitor failures and their consequences, lessen the likelihood of failures that might cause harm and take appropriate remedial actions. Buyer will fully indemnify TI and its representatives against any damages arising out of the use of any TI components in safety-critical applications.

In some cases, TI components may be promoted specifically to facilitate safety-related applications. With such components, TI's goal is to help enable customers to design and create their own end-product solutions that meet applicable functional safety standards and requirements. Nonetheless, such components are subject to these terms.

No TI components are authorized for use in FDA Class III (or similar life-critical medical equipment) unless authorized officers of the parties have executed a special agreement specifically governing such use.

Only those TI components which TI has specifically designated as military grade or "enhanced plastic" are designed and intended for use in military/aerospace applications or environments. Buyer acknowledges and agrees that any military or aerospace use of TI components which have **not** been so designated is solely at the Buyer's risk, and that Buyer is solely responsible for compliance with all legal and regulatory requirements in connection with such use.

TI has specifically designated certain components as meeting ISO/TS16949 requirements, mainly for automotive use. In any case of use of non-designated products, TI will not be responsible for any failure to meet ISO/TS16949.

Products

Audio	www.ti.com/audio
Amplifiers	amplifier.ti.com
Data Converters	dataconverter.ti.com
DLP® Products	www.dlp.com
DSP	dsp.ti.com
Clocks and Timers	www.ti.com/clocks
Interface	interface.ti.com
Logic	logic.ti.com
Power Mgmt	power.ti.com
Microcontrollers	microcontroller.ti.com
RFID	www.ti-rfid.com
OMAP Applications Processors	www.ti.com/omap
Wireless Connectivity	www.ti.com/wirelessconnectivity

Applications

Automotive and Transportation	www.ti.com/automotive
Communications and Telecom	www.ti.com/communications
Computers and Peripherals	www.ti.com/computers
Consumer Electronics	www.ti.com/consumer-apps
Energy and Lighting	www.ti.com/energy
Industrial	www.ti.com/industrial
Medical	www.ti.com/medical
Security	www.ti.com/security
Space, Avionics and Defense	www.ti.com/space-avionics-defense
Video and Imaging	www.ti.com/video

TI E2E Community

e2e.ti.com