

Contact Code

503-Fork Tail .115x.025(2.92x0.64) - Tail LG.=.398(10.11)

THIS IS A C.A.D. GENERATED DRAWING
DO NOT MAKE MANUAL REVISIONS TO MASTER.



ISSUE NUMBER

ORIGINAL ①

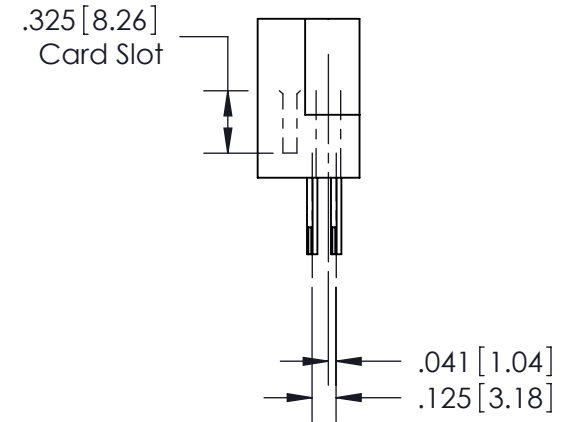
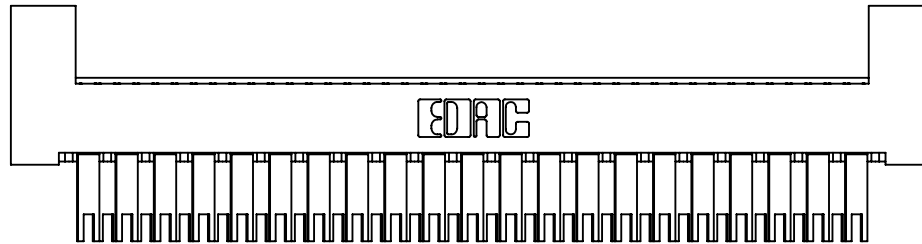
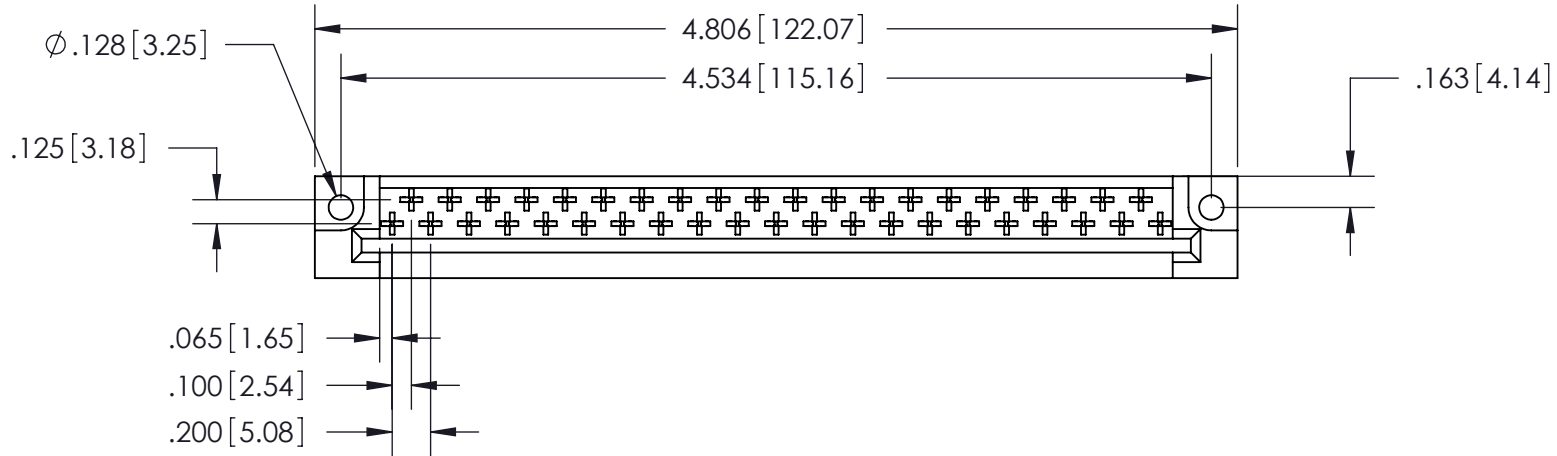

See Accompanying Pages for:
• Features and Specifications

408/424 Series High Reliability Interlock Connector
PART NUMBER: 408-041-503-212



YOUR CONNECTION TO QUALITY & SERVICE

EDAC INC
TORONTO, ONTARIO
CANADA

THESE DRAWINGS AND SPECIFICATIONS
ARE THE PROPERTY OF EDAC INC. AND
SHALL NOT BE REPRODUCED, OR COPIED
OR USED AS THE BASIS FOR THE
MANUFACTURE OR SALE OF APPARATUS
WITHOUT WRITTEN PERMISSION.

ACAD REFERENCE NO. 408-ENG-MASTER

DRAWN: J.LEE DATE: SEPT. 16/09

CHECKED: DATE:

SCALE: NTS SHEET 1 OF 1

DRAWING NUMBER 408-ENG-MASTER ISSUE 1