

**CEL**

# 1 Mbps, OPEN COLLECTOR OUTPUT, FOR GATE DRIVE INTERFACE HIGH CMR, INTELLIGENT POWER MODULE 5-PIN SOP PHOTOCOUPLER

**PS9113****FEATURES**

- **HIGH VCC**  
35 V MAX
- **HIGH COMMON MODE TRANSIENT IMMUNITY**  
CMH, CML =  $\pm 15$  kV/ $\mu$ s MIN
- **SMALL PACKAGE**  
5-pin SOP
- **HIGH SPEED RESPONSE**  
 $t_{PHL} = 500$  ns MAX,  $t_{PLH} = 750$  ns MAX
- **PULSE WIDTH DISTORTION**  
 $|t_{PHL} - t_{PLH}| = 270$  ns TYP
- **AVAILABLE IN TAPE AND REEL**  
PS9113-F3, F4: 2500 pcs/reel

**DESCRIPTION**

NEC's PS9113 is an optically coupled isolator containing a GaAIAs LED on the input side and a photodiode and a signal processing circuit on the output side on one chip.

**APPLICATIONS**

- **IPM DRIVER**
- **GENERAL PURPOSE INVERTER**

**ELECTRICAL CHARACTERISTICS** ( $T_A = -40$  to  $+100^\circ\text{C}$ ,  $V_{CC} = 15$  V, Unless otherwise specified)

		PART NUMBER	PS9113			
	SYMBOL	PARAMETERS	UNITS	MIN	TYP <sup>1</sup>	MAX
Diode	$V_F$	Forward Voltage, $I_F = 10$ mA	V	1.3	1.65	2.1
	$I_R$	Reverse Current, $V_R = 3$ V	$\mu$ A			200
	$C_t$	Terminal Capacitance, $V = 0$ , $f = 1$ MHz, $T_A = 25^\circ\text{C}$	pF		30	
Detector	$I_{OH}$	High Level Output Current $V_{CC} = 30$ V, $V_F = 0.8$ V	$\mu$ A		0.01	50
	$V_{OL}$	Low Level Output Voltage <sup>2</sup> $I_F = 10$ mA, $V_{CC} = 5$ V, $I_{OL} = 2.4$ mA	V		0.13	0.6
	$I_{CCH}$	High Level Supply Current, $V_{CC} = 30$ V, $I_F = 0.8$ V, $V_O = \text{open}$	mA		0.6	1.3
	$I_{CCL}$	Low Level Supply Current, $V_{CC} = 30$ V, $I_F = 10$ V, $V_O = \text{open}$	mA		0.6	1.3
Coupled	$I_{FHL}$	Threshold Input Current, High $\rightarrow$ Low, $V_O = 0.8$ V, $I_O = 0.75$ mA	mA		1.5	5.0
	CTR	Current Transfer Ratio ( $I_C/I_F$ ), $I_F = 10$ mA, $V_O = 0.6$ V	%	44	110	
	$R_{I-O}$	Isolation Resistance, $V_{I-O} = 1$ k Vdc, $R_H = 40$ to $60\%$ , $T_A = 25^\circ\text{C}$	$\Omega$	$10^{11}$		
	$C_{I-O}$	Isolation Capacitance, $V = 0$ , $f = 1$ MHz, $T_A = 25^\circ\text{C}$	pF		0.6	
	$t_{PHL}$	Propagation Delay Time <sup>2</sup> , High $\rightarrow$ Low $I_F = 10$ mA, $R_L = 20$ k $\Omega$ , $C_L = 100$ pF, $V_{THHL} = 1.5$ V, $V_{THLH} = 2.0$ V	ns		250	500
	$t_{PLH}$	Propagation Delay Time <sup>2</sup> , Low $\rightarrow$ High $I_F = 10$ mA, $R_L = 20$ k $\Omega$ , $C_L = 100$ pF, $V_{THHL} = 1.5$ V, $V_{THLH} = 2.0$ V	ns		520	750
	$t_{PLH-t_{PHL}}$	Maximum Propagation Delays, Low $\rightarrow$ High $I_F = 10$ mA, $R_L = 20$ k $\Omega$ , $C_L = 100$ pF, $V_{THHL} = 1.5$ V, $V_{THLH} = 2.0$ V	ns	-200	270	650

Continued on next page

**ELECTRICAL CHARACTERISTICS** (TA = -40 to +100°C, VCC = 15 V, Unless otherwise specified), Continued

		PART NUMBER		PS9113		
SYMBOL		PARAMETERS	UNITS	MIN	TYP	MAX
Coupled	tPHL - tPLH	Pulse Width Distortion, (PWD) <sup>3</sup> , VCC = 5 V, RL = 350 Ω, IF = 7.5 mA IF = 10 mA, RL = 20 kΩ, CL = 100 pF, VTHHL = 1.5 V, VTHLH = 2.0 V	ns		270	650
	CMH	Common Mode Transient Immunity at High Level Output <sup>3</sup> , TA = 25°C, IF = 0 mA, VO > 3.0 V, VCM = 1.5 kV, RL = 20 kΩ, CL = 100 pF	kV/μs	15		
	CML	Common Mode Transient Immunity at Low Level Output <sup>3</sup> , TA = 25°C, IF = 10 mA, VO < 1.0 V, VCM = 1.5 kV, RL = 20 kΩ, CL = 100 pF	kV/μs	15		

Notes:

1. Typical values at TA = 25°C.
2. Test Circuit for Propagation delay time

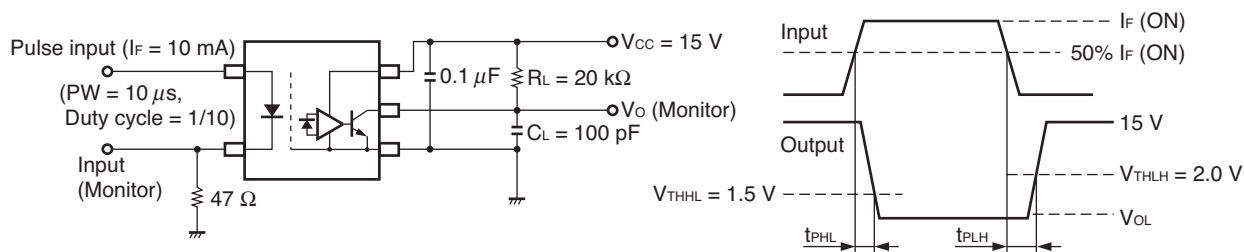

3. Test Circuit for common mode transient immunity

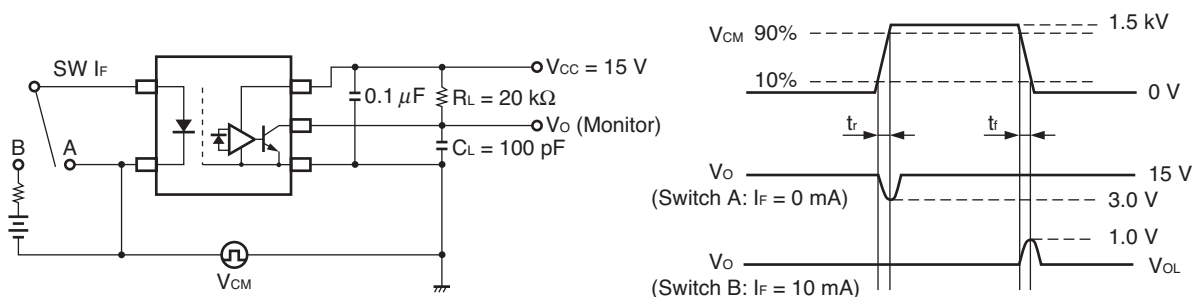

**Remark** CL includes probe and stray wiring capacitance.

**USAGE CAUTIONS**

1. This device is ESD sensitive.
2. Bypass capacitor of more than 0.1 μF is used between VCC and GND near device. Also, ensure that the distance between the leads of the photocoupler and capacitor is no more than 10 mm.

**FUNCTIONAL DIAGRAM**

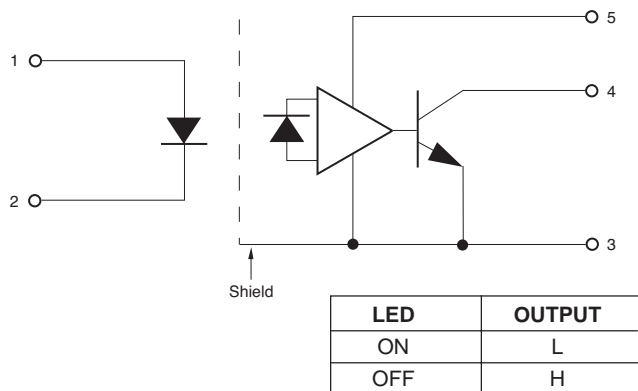

**ABSOLUTE MAXIMUM RATINGS<sup>1</sup>** (TA = 25°C)

SYMBOLS	PARAMETERS	UNITS	RATINGS
<b>Diode</b>			
IF	Forward Current <sup>2</sup>	mA	25
VR	Reverse Voltage	V	5
<b>Detector</b>			
VCC	Supply Voltage	V	-0.5 to +35
VO	Output Voltage	V	-0.5 to +35
IO	Output Current	mA	15
PC	Power Dissipation <sup>3</sup>	mW	100
<b>Coupled</b>			
BV	Isolation Voltage <sup>4</sup>	V <sub>r.m.s.</sub>	2500
TA	Operating Temperature	°C	-40 to +100
TSTG	Storage Temperature	°C	-55 to +125

Notes:

1. Operation in excess of any one of these parameters may result in permanent damage.
2. Reduced to 0.33 mA/°C at TA = 70 °C or more.
3. Reduced to 1.9 mW/°C at TA = 70 °C or more.
4. AC voltage for 1 minute at TA = 25 °C, RH = 60% between input and output.

TYPICAL PERFORMANCE CURVES (TA = 25°C)

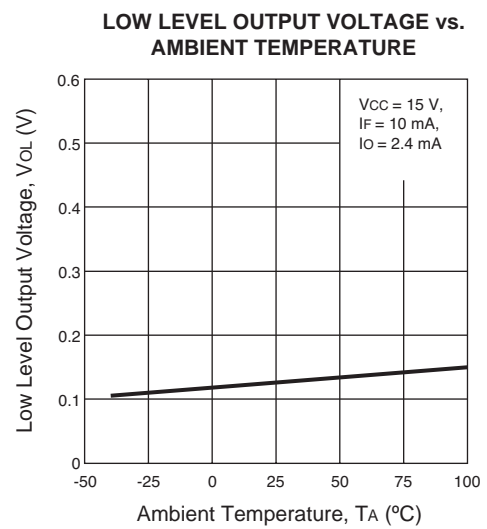
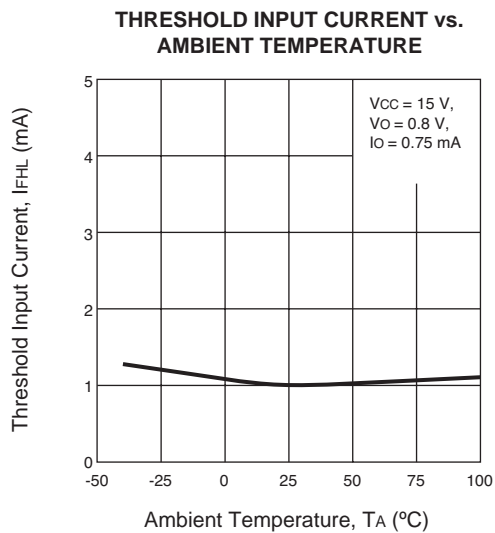
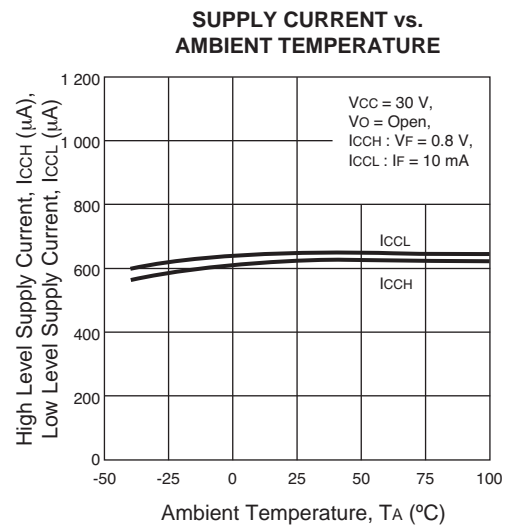
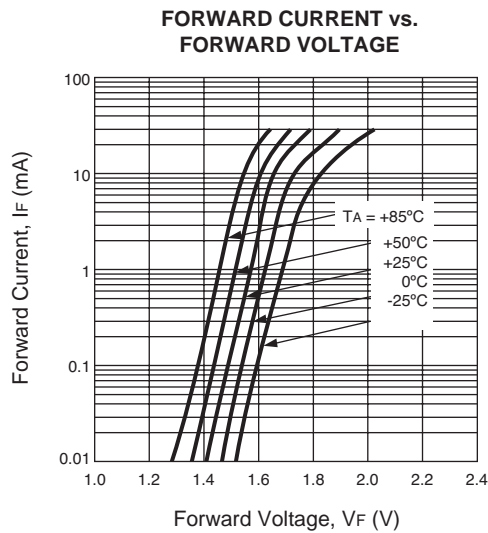
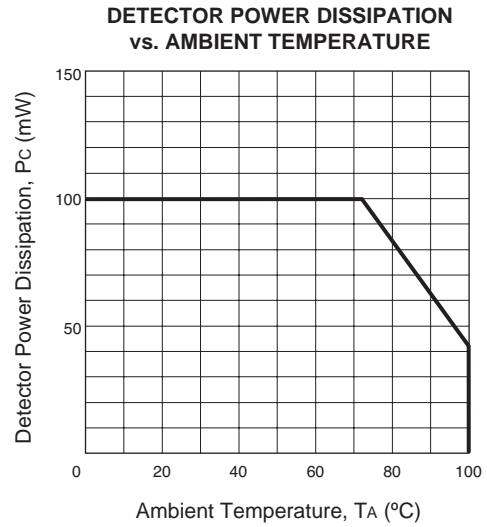
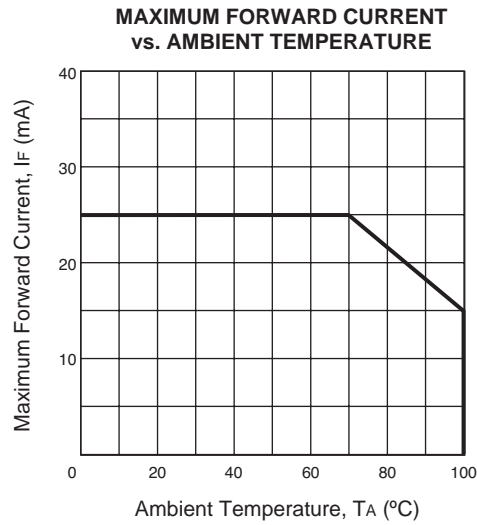

TYPICAL PERFORMANCE CURVES (TA = 25°C)

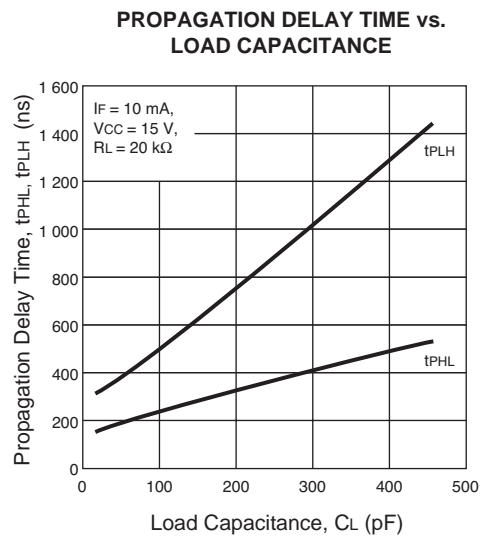
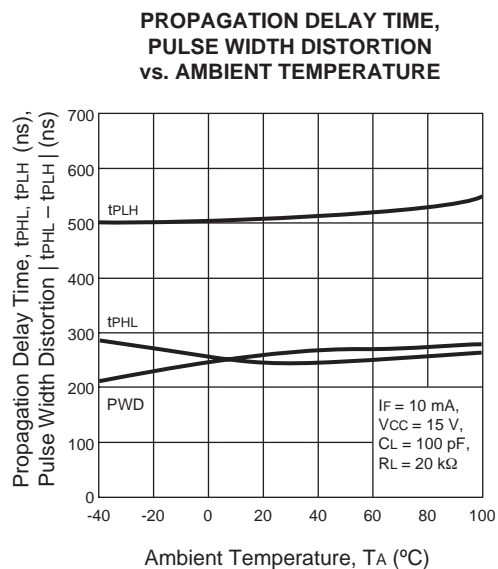
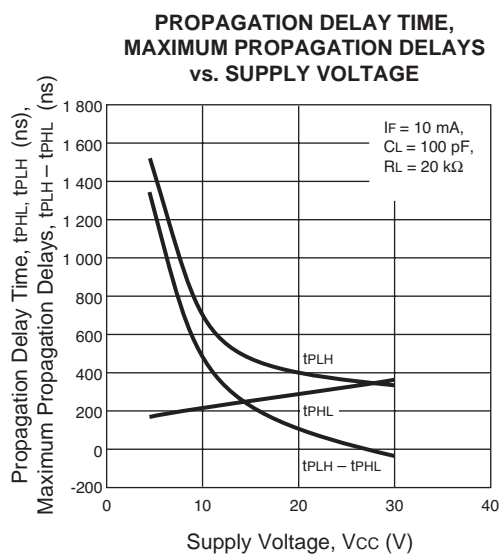
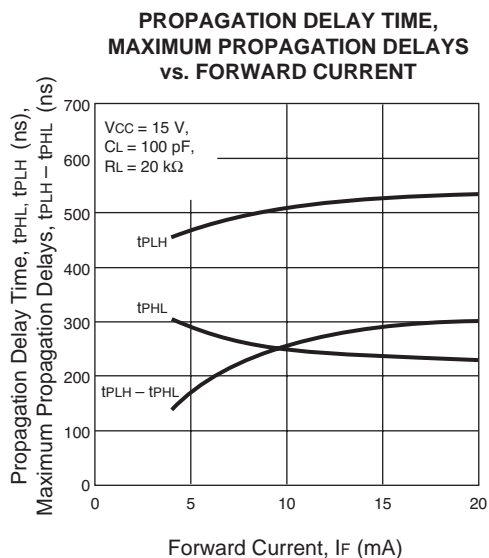
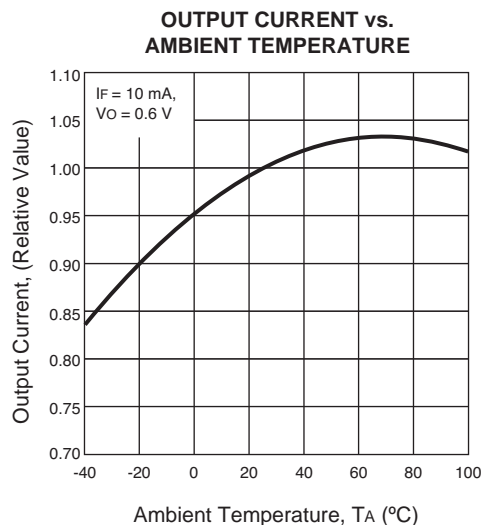
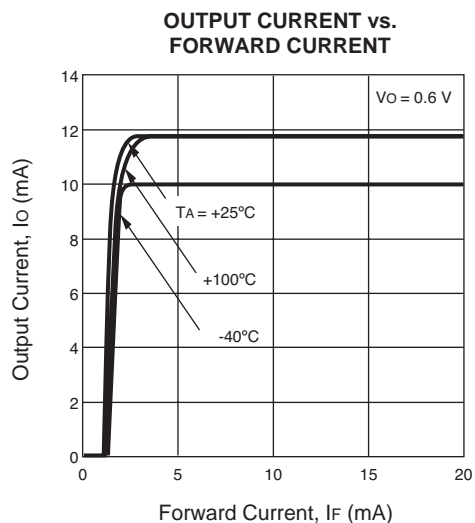

TYPICAL PERFORMANCE CURVES (TA = 25°C)

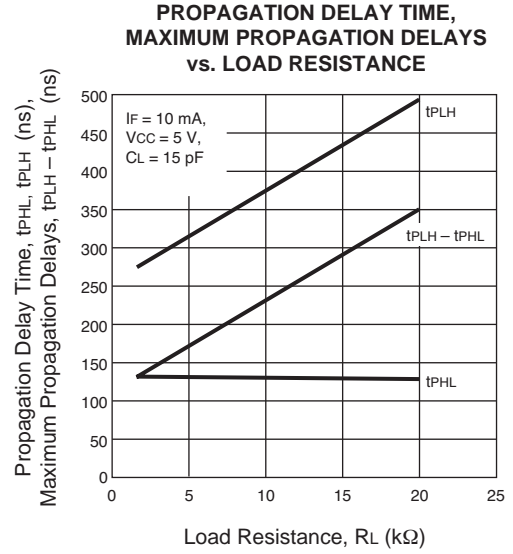
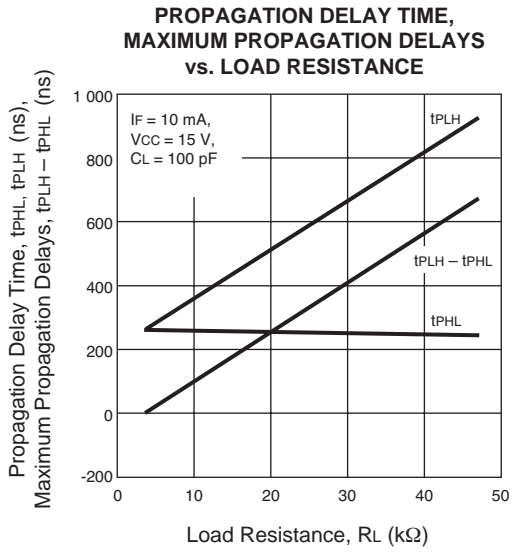

**OUTLINE DIMENSIONS** (Units in mm)

PS9113

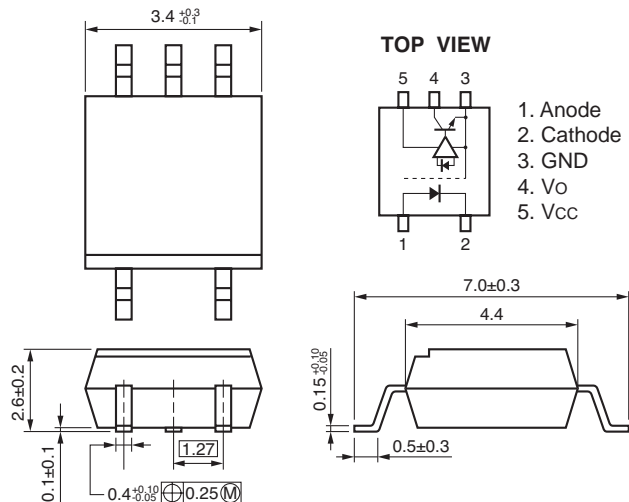

**MARKING**

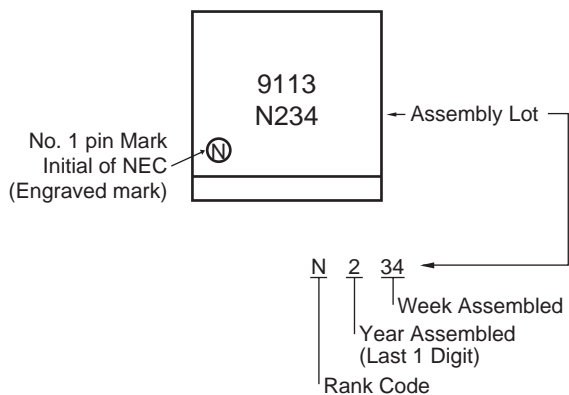

**RECOMMENDED OPERATING CONDITIONS**

PART NUMBER			PS9113		
SYMBOLS	PARAMETERS	UNITS	MIN	TYP	MAX
IFH	High Level Input Current	mA	10		20
Vo	Output Voltage	V	0		30
Vcc	Supply Voltage	V	4.5		30
Vf	LED Off Voltage	V	0		0.8

**ORDERING INFORMATION**

PART NUMBER	PACKAGE	PACKAGE STYLE	APPLICATION PART NUMBER*
PS9113	5-pin SOP	Magazine case 100 PCS	PS9113
PS9113-F3		Embossed Tape 2500 pcs/reel	
PS9113-F4			

\* For the application of the Safety Standard, following part number should be used.

Life Support Applications

These NEC products are not intended for use in life support devices, appliances, or systems where the malfunction of these products can reasonably be expected to result in personal injury. The customers of CEL using or selling these products for use in such applications do so at their own risk and agree to fully indemnify CEL for all damages resulting from such improper use or sale.

**CEL** California Eastern Laboratories, Your source for NEC RF, Microwave, Optoelectronic, and Fiber Optic Semiconductor Devices.  
4590 Patrick Henry Drive • Santa Clara, CA 95054-1817 • (408) 988-3500 • FAX (408) 988-0279 • [www.cel.com](http://www.cel.com)

DATA SUBJECT TO CHANGE WITHOUT NOTICE

09/10/2003