

# SQE48T20033

## Eighth-Brick DC-DC Converter

The new High Temperature 20 A SemiQ™ Family of dc-dc converters provides a high efficiency single output in a size that is only 60% of industry-standard quarter-bricks. Specifically designed for operation in systems that have limited airflow and increased ambient temperatures, the SQE48T20033 eighth-brick converters utilize the same pinout and functionality of the industry-standard quarter-bricks.

The 20 A SQE48T Series converters of the SemiQ™ Family provide thermal performance in high temperature environments that exceeds many competitors' 25 A and 30 A quarter-bricks. This is accomplished through the use of patent pending circuits, packaging, and processing techniques to achieve ultra-high efficiency, excellent thermal management and a low body profile.

Low body profile and the preclusion of heat sinks minimize airflow shadowing, thus enhancing cooling for downstream devices. The use of 100% automation for assembly, coupled with advanced electronic circuits and thermal design, results in a product with extremely high reliability.

Operating from a 36-75V input, the 20A SQE48T Series converters provides a standard output voltage 3.3V. The outputs can be trimmed from -20% to +10% of the nominal output voltage, thus providing outstanding design flexibility.

With standard pinout and trim equations, the SQE48T Series converters are perfect drop-in replacements for competing quarter-brick designs. Inclusion of this converter in new designs can result in significant board space and cost savings. The designer can expect reliability improvement over other available converters because of the SQE48T Series' optimized thermal efficiency.

### Key Features & Benefits

- Delivers 20 A with no derating up to 70 °C
- Industry-standard quarter-brick pinout
- On-board input differential LC-filter
- Start-up into pre-biased load
- No minimum load required
- Weight: 0.72 oz [20.6 g]
- Meets Basic Insulation requirements of EN6095
- Withstands 100 V input transient for 100 ms
- Fixed-frequency operation
- Fully protected
- Remote output sense
- Positive or negative logic ON/OFF option
- Output voltage trim range: +10%/-20% with Industry Standard trim equations
- Designed to meet Class B conducted emissions per FCC and EN 55022 when used with external filter
- All materials meet UL94, V-0 flammability rating
- RoHS lead-free solder and lead-solder-exempted products are available
- Approved to the latest edition and amendment of ITE Safety standards UL/CSA 60950-1

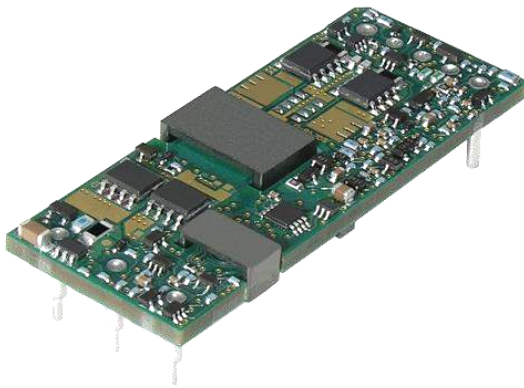

**bel** POWER  
SOLUTIONS &  
PROTECTION

a bel group

[belpowersolutions.com](http://belpowersolutions.com)

## 1. ELECTRICAL SPECIFICATIONS

Extremely small footprint: 0.896" x 2.30" (2.06 in<sup>2</sup>), 38% smaller than conventional quarter bricks.

PARAMETER	DESCRIPTION / CONDITION	MIN	NOM	MAX	UNIT
<b>Absolute Maximum Ratings</b>					
Input Voltage	Continuous	0		80	VDC
Operating Ambient Temperature		-40		85	°C
Storage Temperature		-55		125	°C
<b>Input Characteristics</b>					
Operating Input Voltage Range		36	48	75	VDC
Input Under Voltage Lockout	Non-latching				
Turn-on Threshold		33	34	35	VDC
Turn-off Threshold		31	32	33	VDC
Input Voltage Transient	100 ms			100	VDC
<b>Isolation Characteristics</b>					
I/O Isolation		2000			VDC
Isolation Capacitance			160		pF
Isolation Resistance		10			MΩ
<b>Feature Characteristics</b>					
Switching Frequency			480		kHz
Output Voltage Trim Range <sup>1</sup>	Industry-std. equations	-20		+10	%
Remote Sense Compensation <sup>1</sup>	Percent of V <sub>OUT</sub> (NOM)			+10	%
Output Over-Voltage Protection	Non-latching	117	122	127	%
Over-Temperature Shutdown (PCB)	Non-latching		125		°C
Auto-Restart Period	Applies to all protection features		200		ms
Turn-On Time			4		ms
ON/OFF Control (Positive Logic)	Converter Off (logic low)	-20		0.8	VDC
	Converter On (logic high)	2.4		20	VDC
ON/OFF Control (Negative Logic)	Converter Off (logic high)	2.4		20	VDC
	Converter On (logic low)	-20		0.8	VDC
<b>Input Characteristics</b>					
Maximum Input Current	20 ADC, 3.3 VDC Out @ 36 VDC In			2	ADC
Input Stand-by Current	V <sub>in</sub> = 48 V, converter disabled		2		mADC
Input No Load Current (0 load on the output)	V <sub>in</sub> = 48 V, converter enabled		38		mADC
Input Reflected-Ripple Current	20 MHz bandwidth		6		mA <sub>PK-PK</sub>
Input Voltage Ripple Rejection	120 Hz		75		dB

<sup>1</sup> V<sub>out</sub> can be increased up to 10% via the sense leads or up to 10% via the trim function. However, the total output voltage trim from all sources should not exceed 10% of V<sub>OUT</sub> (NOM), in order to insure specified operation of overvoltage protection circuitry.

<b>Output Characteristics</b>					
Output Voltage Set Point (no load)		3.275	3.300	3.325	VDC
Output Regulation	Over Line		±2	±5	mV
	Over Load		±2	±5	mV
Output Voltage Range	Over line, load and temp. (-40°C to 85°C)	3.250		3.350	VDC
Output Ripple and Noise - 25 MHz bandwidth	Full load + 10 µF tantalum + 1 µF ceramic		35	70	mV <sub>PK-PK</sub>
External Load Capacitance	Plus full load (resistive)			20,000	µF
Output Current Range		0		20	ADC
Current Limit Inception	Non-latching	21	25	29	ADC
Peak Short-Circuit Current	Non-latching. Short=10mΩ.		25		A
RMS Short-Circuit Current	Non-latching. Short=10mΩ.		4	8	Arms
<b>Dynamic Response</b>					
Load Change 10A-15A-10A, di/dt =0.1A/µs	Co = 1 µF ceramic		20		mV
di/dt = 5A/µs	Co = 470 µF POS + 1 µF ceramic		110		mV
Settling Time to 1%			15		µs
<b>Efficiency</b>					
100% Load			92		%
50% Load			92		%

## 2. OPERATIONS

### 2.1 INPUT AND OUTPUT IMPEDANCE

These power converters have been designed to be stable with no external capacitors when used in low inductance input and output circuits.

In many applications, the inductance associated with the distribution from the power source to the input of the converter can affect the stability of the converter. The addition of a 33 µF electrolytic capacitor with an ESR < 1Ω across the input helps ensure stability of the converter. In many applications, the user has to use decoupling capacitance at the load. The power converter will exhibit stable operation with external load capacitance up to 20,000 µF on 3.3 V outputs. Additionally, see the EMC section of this data sheet for discussion of other external components which may be required for control of conducted emissions.

### 2.2 ON/OFF (Pin 2)

The ON/OFF pin is used to turn the power converter on or off remotely via a system signal. There are two remote control options available, positive logic and negative logic and both are referenced to Vin (-). A typical connection is shown in Figure A.

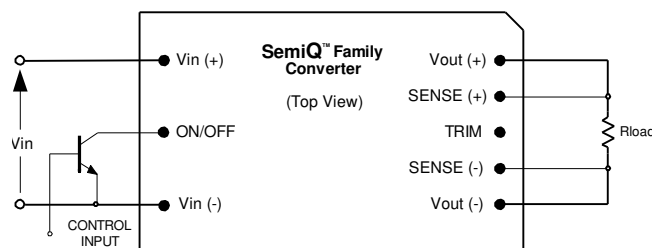

Figure A. Circuit configuration for ON/OFF function.

The positive logic version turns on when the ON/OFF pin is at a logic high and turns off when at a logic low. The converter is on when the ON/OFF pin is left open. See table, page 2 for logic high/low definitions.

The negative logic version turns on when the pin is at a logic low and turns off when the pin is at a logic high. The ON/OFF pin can be hard wired directly to Vin (-) to enable automatic power up of the converter without the need of an external control signal.

The ON/OFF pin is internally pulled-up to 5V through a resistor. A properly debounced mechanical switch, open collector transistor, or FET can be used to drive the input of the ON/OFF pin. The device must be capable of sinking up to 0.2mA at a low level voltage of  $\leq 0.8V$ . An external voltage source ( $\pm 20V$  maximum) may be connected directly to the ON/OFF input, in which case it must be capable of sourcing or sinking up to 1 mA depending on the signal polarity. See the Start-up Information section for system timing waveforms associated with use of the ON/OFF pin.

### 2.3 REMOTE SENSE (PINS 5 AND 7)

The remote sense feature of the converter compensates for voltage drops occurring between the output pins of the converter and the load. The SENSE(-) (Pin 5) and SENSE(+) (Pin 7) pins should be connected at the load or at the point where regulation is required (see Fig. B).

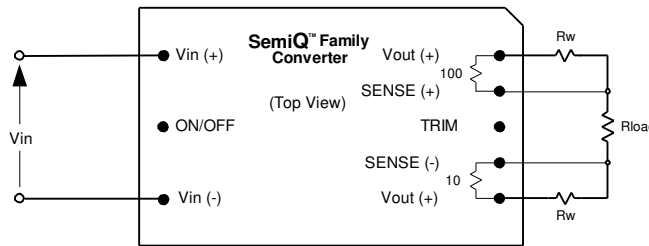

Figure B. Remote sense circuit configuration.

If remote sensing is not utilized, the SENSE(-) pin must be connected to the Vout(-) pin (Pin 4), and the SENSE(+) pin must be connected to the Vout(+) pin (Pin 8) to ensure the converter will regulate at the specified output voltage. If these connections are not made, the converter will deliver an output voltage that is slightly higher than the specified data sheet value.

Because the sense leads carry minimal current, large traces on the end-user board are not required. However, sense traces should be run side by side and located close to a ground plane to minimize system noise and insure optimum performance.

When using the remote sense function, the converter's output over-voltage protection (OVP) senses the voltage across Vout(+) and Vout(-), and not across the sense lines, so the resistance (and resulting voltage drop) between the output pins of the converter and the load should be minimized to prevent unwanted triggering of the OVP.

When utilizing the remote sense feature, care must be taken not to exceed the maximum allowable output power capability of the converter, equal to the product of the nominal output voltage and the allowable output current for the given conditions. When using remote sense, the output voltage at the converter can be increased by as much as 10% above the nominal rating in order to maintain the required voltage across the load. Therefore, the designer must, if necessary, decrease the maximum current (originally obtained from the derating curves) by the same percentage to ensure the converter's actual output power remains at or below the maximum allowable output power.

### 2.4 OUTPUT VOLTAGE ADJUST / TRIM (PIN 6)

The output voltage can be adjusted up 10% or down 20% relative to the rated output voltage by the addition of an externally connected resistor. For output voltage 3.3V, trim up to 10% is guaranteed only at  $V_{in} \geq 40V$ , and it is marginal (8% to 10%) at  $V_{in} = 36V$ .

The TRIM pin should be left open if trimming is not being used. To minimize noise pickup, a 0.1 $\mu F$  capacitor is connected internally between the TRIM and SENSE(-) pins.

To increase the output voltage, refer to Fig. C. A trim resistor,  $R_{T-INCR}$ , should be connected between the TRIM (Pin 6) and SENSE(+) (Pin 7), with a value of:

$$R_{T-INCR} = \frac{5.11(100 + \Delta)V_{O-NOM} - 626}{1.225\Delta} - 10.22 \quad [k\Omega]$$

where,

$R_{T-INCR}$  = Required value of trim-up resistor  $k\Omega$

$V_{O-NOM}$  = Nominal value of output voltage [V]

$$\Delta = \left| \frac{(V_{O-REQ} - V_{O-NOM})}{V_{O-NOM}} \right| \times 100 \quad [\%]$$

$V_{O-REQ}$  = Desired (trimmed) output voltage [V].

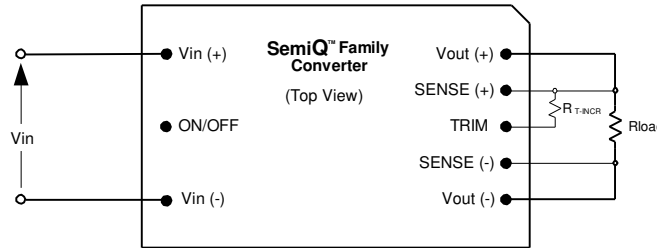

Figure C. Configuration for increasing output voltage.

When trimming up, care must be taken not to exceed the converter’s maximum allowable output power. See previous section for a complete discussion of this requirement.

To decrease the output voltage (Fig. D), a trim resistor,  $R_{T-DECR}$ , should be connected between the TRIM (Pin 6) and SENSE(-) (Pin 5), with a value of:

$$R_{T-DECR} = \frac{511}{\Delta} - 10.22 \quad [k\Omega]$$

where,

$R_{T-DECR}$  = Required value of trim-down resistor [kΩ]

and  $\Delta$  is defined above.

**NOTE:**

The above equations for calculation of trim resistor values match those typically used in conventional industry-standard quarter-bricks and one-eighth bricks.

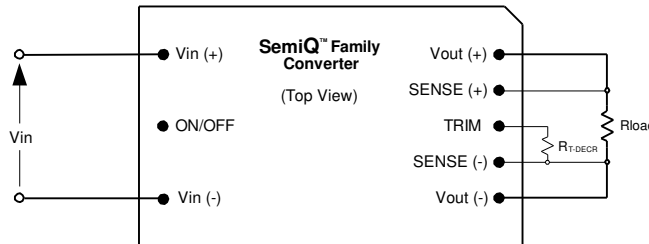

Figure D. Configuration for decreasing output voltage.

Trimming/sensing beyond 110% of the rated output voltage is not an acceptable design practice, as this condition could cause unwanted triggering of the output overvoltage protection (OVP) circuit. The designer should ensure that the difference between the voltages across the converter’s output pins and its sense pins does not exceed 10% of  $V_{OUT(nom)}$ , or:

$$[V_{OUT(+)} - V_{OUT(-)}] - [V_{SENSE(+)} - V_{SENSE(-)}] \leq V_{O-NOM} \times 10\% \quad [V]$$

This equation is applicable for any condition of output sensing and/or output trim.

### 3. PROTECTION FEATURES

#### 3.1 INPUT UNDERVOLTAGE LOCKOUT

Input undervoltage lockout is standard with this converter. The converter will shut down when the input voltage drops below a pre-determined voltage.

The input voltage must be typically 34V for the converter to turn on. Once the converter has been turned on, it will shut off when the input voltage drops typically below 32V. This feature is beneficial in preventing deep discharging of batteries used in telecom applications.

#### 3.2 OUTPUT PROTECTIONS

All output circuit protection features are non-latching and operate in a “hiccup” mode. After an output protection event occurs, the converter will be turned off, and held off for approximately 200 ms after which, the protection circuit will reset and the converter will attempt to restart. If the fault is still present, the converter will repeat the above action. Once the fault is removed, the converter will start normally.

#### 3.3 OUTPUT OVERCURRENT PROTECTION (OCP)

The converter is protected against overcurrent or short circuit conditions. Upon sensing an over-current condition, the converter will switch to constant current operation and thereby begin to reduce output voltage. When the output voltage drops below 60% of the nominal value of output voltage, the converter will shut down (Fig. 15).

Once the converter has shut down, it will attempt to restart nominally every 200 ms with a typical 3-5% duty cycle (Fig. 16). The attempted restart will continue indefinitely until the overload or short circuit conditions are removed or the output voltage rises above 40-50% of its nominal value.

Once the output current is brought back into its specified range, the converter automatically exits the hiccup mode and continues normal operation.

#### 3.4 OUTPUT OVERVOLTAGE PROTECTION (OVP)

The converter will shut down if the output voltage across Vout(+) (Pin 8) and Vout(-) (Pin 4) exceeds the threshold of the OVP circuitry. The OVP circuitry contains its own reference, independent of the output voltage regulation loop. Once the converter has shut down, it will attempt to restart every 200 ms until the OVP condition is removed.

#### 3.5 OVERTEMPERATURE PROTECTION (OTP)

The converter will shut down under an over-temperature condition to protect itself from overheating caused by operation outside the thermal derating curves, or operation in abnormal conditions such as system fan failure. After the converter has cooled to a safe operating temperature, it will automatically restart.

#### 3.6 SAFETY REQUIREMENTS

The converters meet the requirements of the latest edition and amendment of ITE Safety standards UL/CSA 60950-1. Basic Insulation is provided between input and output.

To comply with safety agencies requirements, an input line fuse must be used external to the converter. A 4A fuse is recommended for use with this product.

All SQE converters are UL approved for maximum fuse rating of 15A. To protect a group of converters with a single fuse, the rating can be increased from the recommended values above.

#### 3.7 ELECTROMAGNETIC COMPATIBILITY (EMC)

EMC requirements must be met at the end-product system level, as no specific standards dedicated to EMC characteristics of board mounted component dc-dc converters exist. However, Bel Power Solutions tests its converters to several system level standards, primary of which is the more stringent EN55022, *Information technology equipment - Radio disturbance characteristics - Limits and methods of measurement*.

Effective internal LC differential filter significantly reduces input reflected ripple current (Fig. 13), and improves EMC.

With the addition of a simple external filter, all versions of the SQE48T Series converters pass the requirements of Class B conducted emissions per EN55022 and FCC requirements. Please contact Bel Power Solutions Applications Engineering for details of this testing.

## 4. CHARACTERIZATION

### 4.1 GENERAL INFORMATION

The converter has been characterized for many operational aspects, to include thermal derating (maximum load current as a function of ambient temperature and airflow) for vertical and horizontal mounting, efficiency, start-up and shutdown parameters, output ripple and noise, transient response to load step-change, overload and short circuit.

The figures are numbered as Fig. x.y, where x indicates the different output voltages, and y associates with specific plots (y = 1 for the vertical thermal derating, ...). For example, Fig. x.1 will refer to the vertical thermal derating for all the output voltages in general.

The following pages contain specific plots or waveforms associated with the converter. Additional comments for specific data are provided below.

### 4.2 TEST CONDITIONS

All data presented were taken with the converter soldered to a test board, specifically a 0.060" thick printed wiring board (PWB) with four layers. The top and bottom layers were not metalized. The two inner layers, comprising two-ounce copper, were used to provide traces for connectivity to the converter.

The lack of metalization on the outer layers as well as the limited thermal connection ensured that heat transfer from the converter to the PWB was minimized. This provides a worst-case but consistent scenario for thermal derating purposes.

All measurements requiring airflow were made in the vertical and horizontal wind tunnel using Infrared (IR) thermography and thermocouples for thermometry.

Ensuring components on the converter do not exceed their ratings is important to maintaining high reliability. If one anticipates operating the converter at or close to the maximum loads specified in the derating curves, it is prudent to check actual operating temperatures in the application. Thermographic imaging is preferable; if this capability is not available, then thermocouples may be used. It is recommended the use of AWG #40 gauge thermocouples to ensure measurement accuracy. Careful routing of the thermocouple leads will further minimize measurement error. Refer to Fig. E for optimum measuring thermocouple locations.

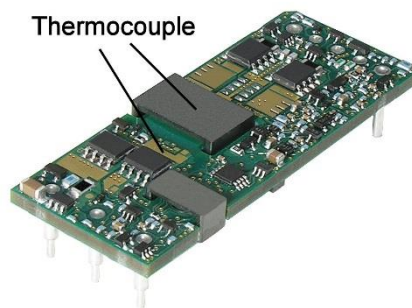

Fig. E: Location of the thermocouple for thermal testing.

### 4.3 THERMAL DERATING

Load current vs. ambient temperature and airflow rates are given in Fig. 1 and Fig. 2. Ambient temperature was varied between 25°C and 85°C, with airflow rates from 30 to 500 LFM (0.15 to 2 m/s), for vertical and horizontal converter mounting.

For each set of conditions, the maximum load current was defined as the lowest of:

- (i) The output current at which any FET junction temperature does not exceed a maximum specified temperature (120 °C) as indicated by the thermographic image, or
- (ii) The temperature of the transformer does not exceed 120 °C, or
- (iii) The nominal rating of the converter (20 A).

During normal operation, derating curves with maximum FET temperature less or equal to 120 °C should not be exceeded. Temperature at both thermocouple locations shown in Fig. E should not exceed 120 °C in order to operate inside the derating curves.

#### 4.4 EFFICIENCY

Efficiency vs. load current plot is shown in Fig. 3 for ambient temperature of 25 °C, airflow rate of 300 LFM (1.5m/s), vertical converter mounting, and input voltages of 36V, 48V and 72V. Also, a plot of efficiency vs. load current, as a function of ambient temperature with  $V_{in} = 48V$ , airflow rate of 200 LFM (1m/s) with vertical mounting is shown in Fig. 4.

#### 4.5 POWER DISSIPATION

Fig. 5 shows the power dissipation vs. load current plot for  $T_a = 25\text{ °C}$ , airflow rate of 300 LFM (1.5m/s) with vertical mounting and input voltages of 36V, 48V and 72V. Also, a plot of power dissipation vs. load current, as a function of ambient temperature with  $V_{in} = 48V$ , airflow rate of 200 LFM (1m/s) with vertical mounting is shown in Fig. 6.

#### 4.6 STARTUP

Output voltage waveforms, during the turn-on transient using the ON/OFF pin for full rated load currents (resistive load) are shown without and with external load capacitance in Fig. 7 and Fig. 8, respectively.

#### 4.7 RIPPLE AND NOISE

Fig. x.11 shows the output voltage ripple waveform, measured at full rated load current with a 10 $\mu$ F tantalum and 1 $\mu$ F ceramic capacitor across the output. Note that all output voltage waveforms are measured across a 1 $\mu$ F ceramic capacitor. The input reflected ripple current waveforms are obtained using the test setup shown in Fig. 12. The corresponding waveforms are shown in Fig. 13 and Fig. 14.



4.8 STARTUP INFORMATION (USING NEGATIVE ON/OFF)

**Scenario #1: Initial Start-up From Bulk Supply**  
 ON/OFF function enabled, converter started via application of  $V_{IN}$ . See Figure E.

Time	Comments
$t_0$	ON/OFF pin is ON; system front end power is toggled on, $V_{IN}$ to converter begins to rise.
$t_1$	$V_{IN}$ crosses Under-Voltage Lockout protection circuit threshold; converter enabled.
$t_2$	Converter begins to respond to turn-on command (converter turn-on delay).
$t_3$	Converter $V_{OUT}$ reaches 100% of nominal value.

For this example, the total converter start-up time ( $t_3 - t_1$ ) is typically 4 ms.

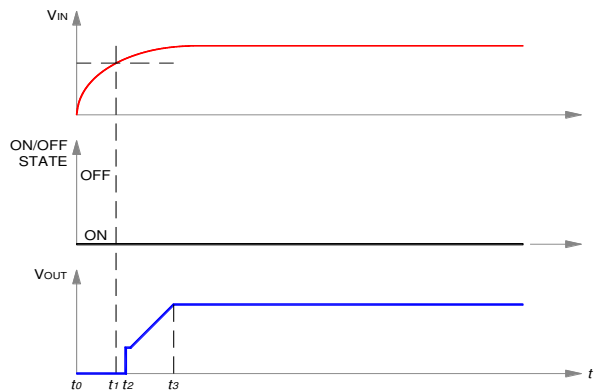

Figure F. Startup scenario #1.

**Scenario #2: Initial Start-up Using ON/OFF Pin**  
 With  $V_{IN}$  previously powered, converter started via ON/OFF pin. See Figure F.

Time	Comments
$t_0$	$V_{INPUT}$ at nominal value.
$t_1$	Arbitrary time when ON/OFF pin is enabled (converter enabled).
$t_2$	End of converter turn-on delay.
$t_3$	Converter $V_{OUT}$ reaches 100% of nominal value.

For this example, the total converter start-up time ( $t_3 - t_1$ ) is typically 4 ms.

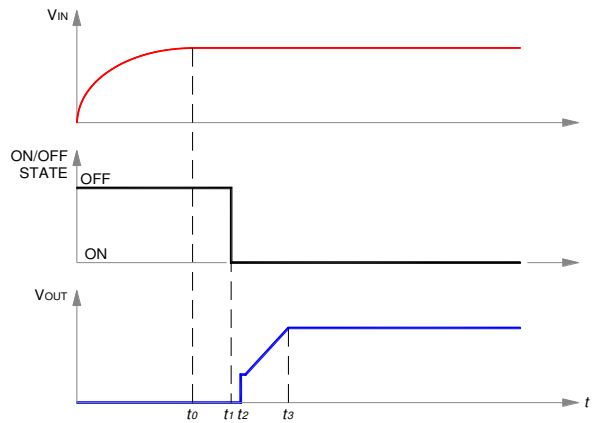

Figure G. Startup scenario #2.

**Scenario #3: Turn-off and Restart Using ON/OFF Pin**  
 With  $V_{IN}$  previously powered, converter is disabled and then enabled via ON/OFF pin. See Figure G.

Time	Comments
$t_0$	$V_{IN}$ and $V_{OUT}$ are at nominal values; ON/OFF pin ON.
$t_1$	ON/OFF pin arbitrarily disabled; converter output falls to zero; turn-on inhibit delay period (200 ms typical) is initiated, and ON/OFF pin action is internally inhibited.
$t_2$	ON/OFF pin is externally re-enabled. If $(t_2 - t_1) \leq 200$ ms, external action of ON/OFF pin is locked out by start-up inhibit timer. If $(t_2 - t_1) > 200$ ms, ON/OFF pin action is internally enabled.
$t_3$	Turn-on inhibit delay period ends. If ON/OFF pin is ON, converter begins turn-on; if off, converter awaits ON/OFF pin ON signal; see Figure F.
$t_4$	End of converter turn-on delay.
$t_5$	Converter $V_{OUT}$ reaches 100% of nominal value.

For the condition,  $(t_2 - t_1) \leq 200$  ms, the total converter start-up time ( $t_5 - t_2$ ) is typically 204 ms. For  $(t_2 - t_1) > 200$  ms, start-up will be typically 4 ms after release of ON/OFF pin.

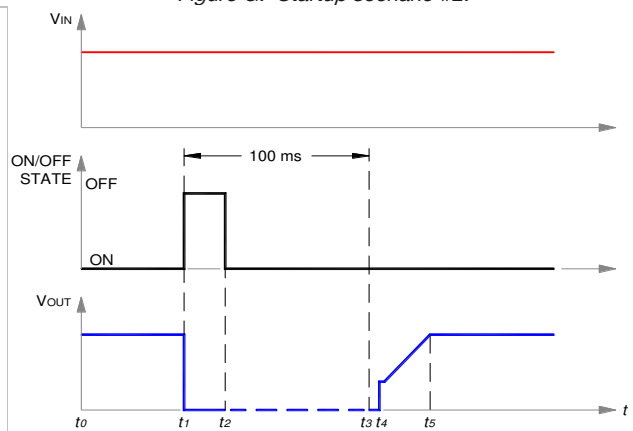

Figure H. Startup scenario #3.



a bel group

Asia-Pacific  
 +86 755 298 85888

Europe, Middle East  
 +353 61 225 977

North America  
 +1 408 785 5200

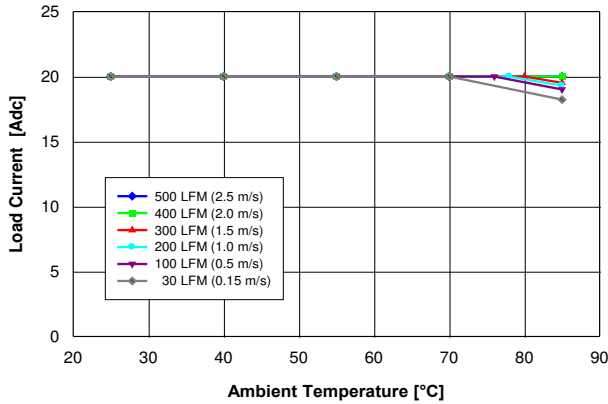

Figure 1. Available load current vs. ambient air temperature and airflow rates for converter with G height pins mounted vertically with air flowing from pin 1 to pin 3 and maximum FET temperature  $\leq 120^{\circ}\text{C}$ ,  $V_{in} = 48\text{ V}$ .

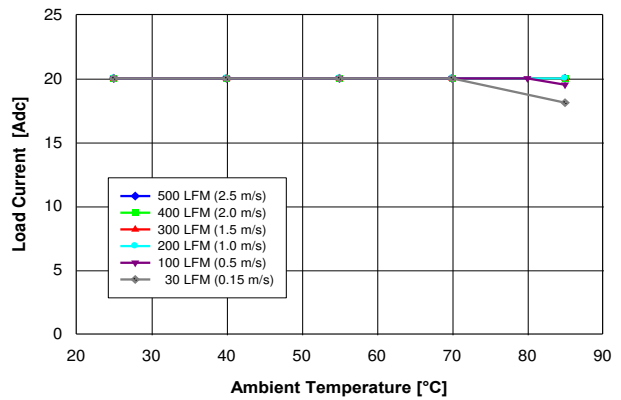

Figure 2. Available load current vs. ambient air temperature and airflow rates for converter with G height pins mounted horizontally with air flowing from pin 1 to pin 3 and maximum FET temperature  $\leq 120^{\circ}\text{C}$ ,  $V_{in} = 48\text{ V}$ .

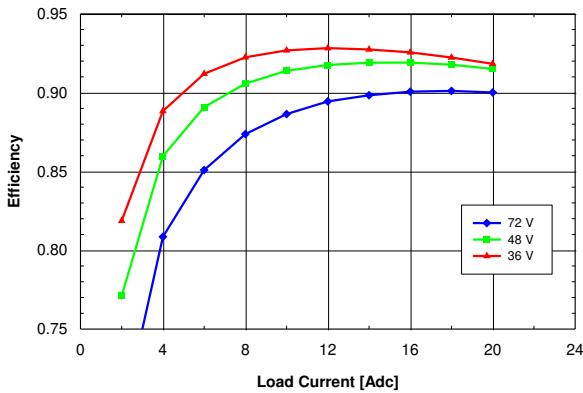

Figure 3. Efficiency vs. load current and input voltage for converter mounted vertically with air flowing from pin 1 to pin 3 at a rate of 300 LFM (1.5 m/s) and  $T_a = 25^{\circ}\text{C}$ .

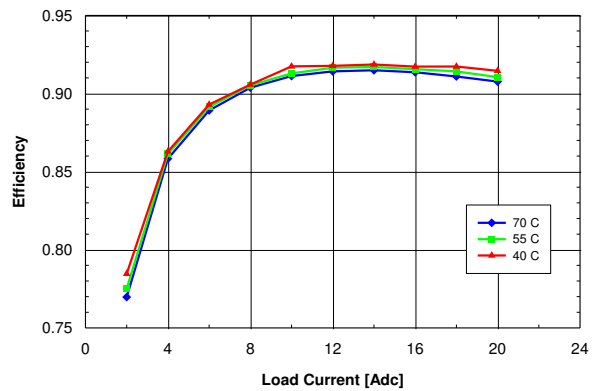

Figure 4. Efficiency vs. load current and ambient temperature for converter mounted vertically with  $V_{in} = 48\text{ V}$  and air flowing from pin 1 to pin 3 at a rate of 200 LFM (1.0 m/s).

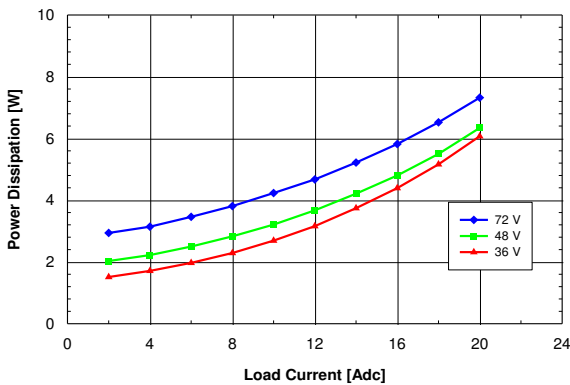

Figure 5. Power dissipation vs. load current and input voltage for converter mounted vertically with air flowing from pin 1 to pin 3 at a rate of 300 LFM (1.5 m/s) and  $T_a = 25^{\circ}\text{C}$ .

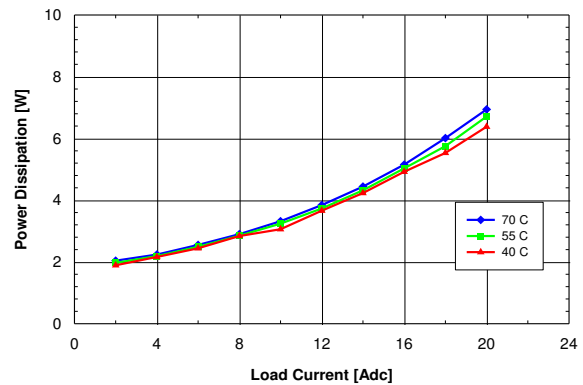

Figure 6. Power dissipation vs. load current and ambient temperature for converter mounted vertically with  $V_{in} = 48\text{ V}$  and air flowing from pin 1 to pin 3 at a rate of 200 LFM (1.0 m/s).

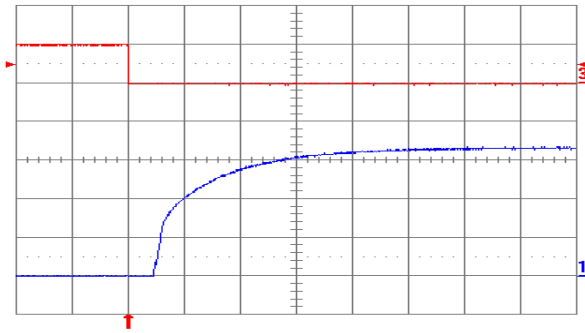

Figure 7. Turn-on transient at full rated load current (resistive) with no output capacitor at  $V_{in} = 48V$ , triggered via ON/OFF pin. Top trace: ON/OFF signal (5 V/div.). Bottom trace: output voltage (5/div.). Time scale: 1 ms/div

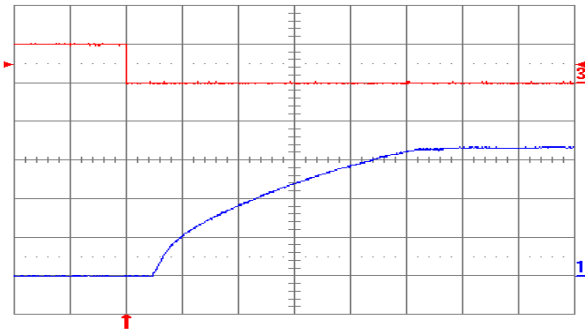

Figure 8. Turn-on transient at full rated load current (resistive) plus 10,000  $\mu F$  at  $V_{in} = 48V$ , triggered via ON/OFF pin. Top trace: ON/OFF signal (5 V/div.). Bottom trace: output voltage (5 V/div.). Time scale: 1 ms/div.

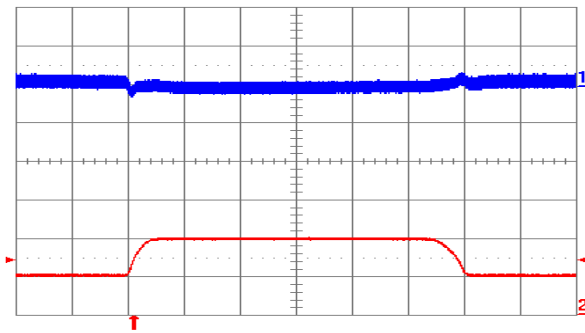

Figure 9. Output voltage response to load current step-change (10A - 20A - 10A) at  $V_{in} = 48V$ . Top trace: output voltage (100 mV/div.). Bottom trace: load current (10 A/div.). Current slew rate: 0.1 A/ $\mu s$ .  $C_o = 1\mu F$  ceramic. Time scale: 0.2 ms/div.

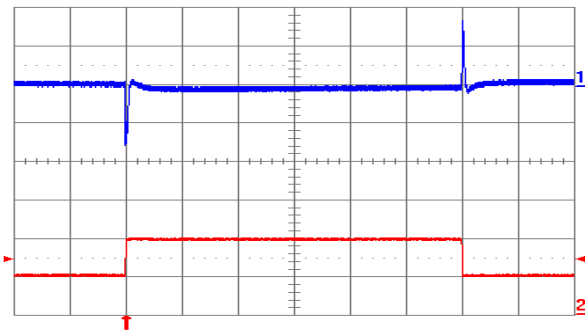

Figure 10. Output voltage response to load current step-change (10A - 20A - 10A) at  $V_{in} = 48V$ . Top trace: output voltage (100mV/div.). Bottom trace: load current (10 A/div.). Current slew rate: 5 A/ $\mu s$ .  $C_o = 470 \mu F$  POS + 1 $\mu F$  ceramic. Time scale: 0.2 ms/div.

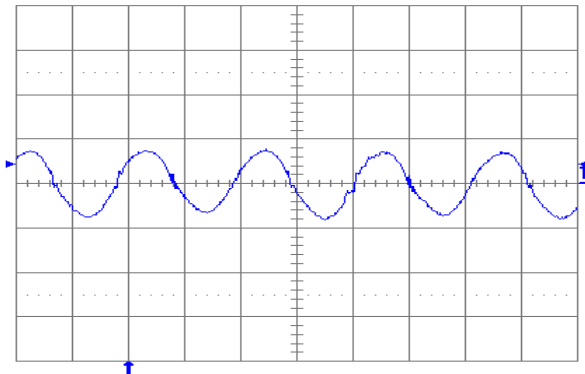

Figure 11. Output voltage ripple (20mV/div.) at full rated load current into a resistive load with  $C_o = 10\mu F$  tantalum + 1Uf ceramic and  $V_{in} = 48V$ . Time scale: 1  $\mu s$ /div.

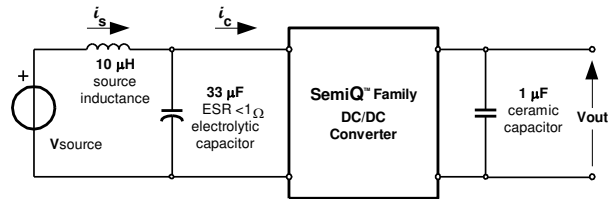

Figure 12. Test setup for measuring input reflected ripple currents,  $i_c$  and  $i_s$

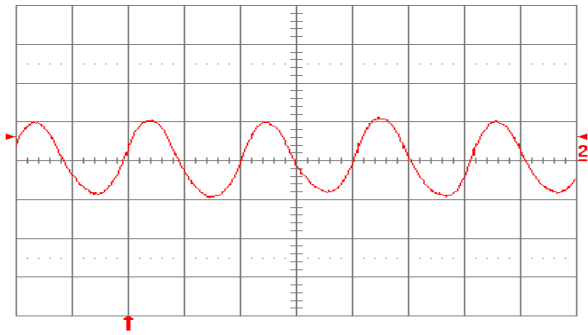

Figure 13. Input reflected ripple current,  $i_c$  (50 mA/div.), measured at input terminals at full rated load current and  $V_{in} = 48V$ . Refer to Fig. 12 for test setup. Time scale: 1  $\mu$ s/div.

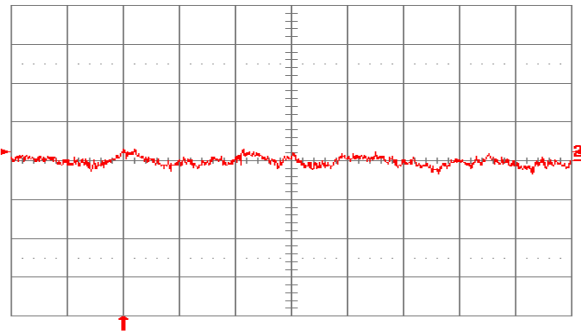

Figure 14. Input reflected ripple current,  $i_s$  (10 mA/div.), measured through 10 $\mu$ H at the source at full rated load current and  $V_{in} = 48V$ . Refer to Fig. 12 for test setup. Time scale: 1  $\mu$ s/div.

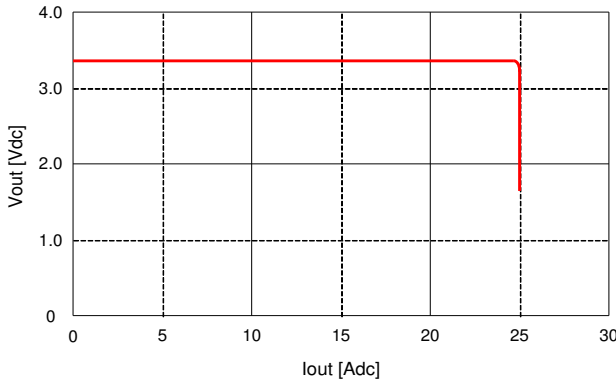

Figure 15. Output voltage vs. load current showing current limit point and converter shutdown point. Input voltage has almost no effect on current limit characteristic.

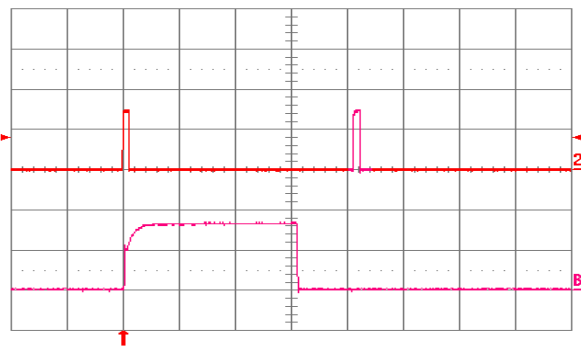

Figure 16. Load current (top trace, 20 A/div., 50 ms/div.) into a 10m $\Omega$  short circuit during restart, at  $V_{in} = 48V$ . Bottom trace (10A/div., 2 ms/div.) is an expansion of the on-time portion of the top trace.

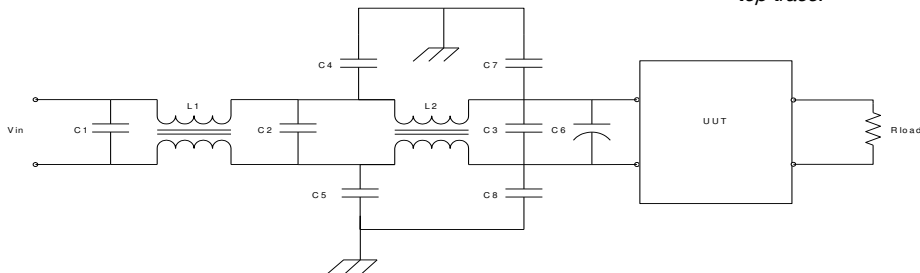

Figure 17. Typical input EMI filter circuit to attenuate conducted emissions

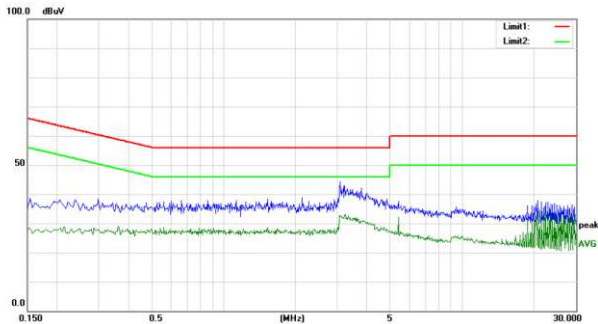

Figure 18.  $V_{in+}$  EMI waveform

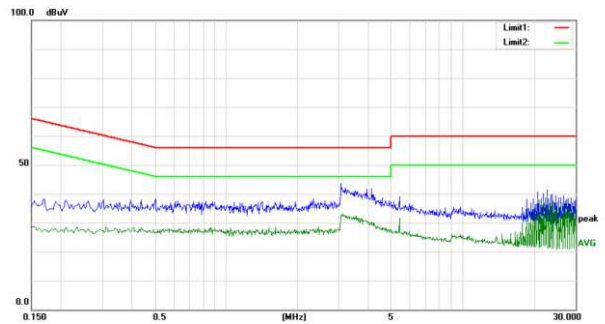
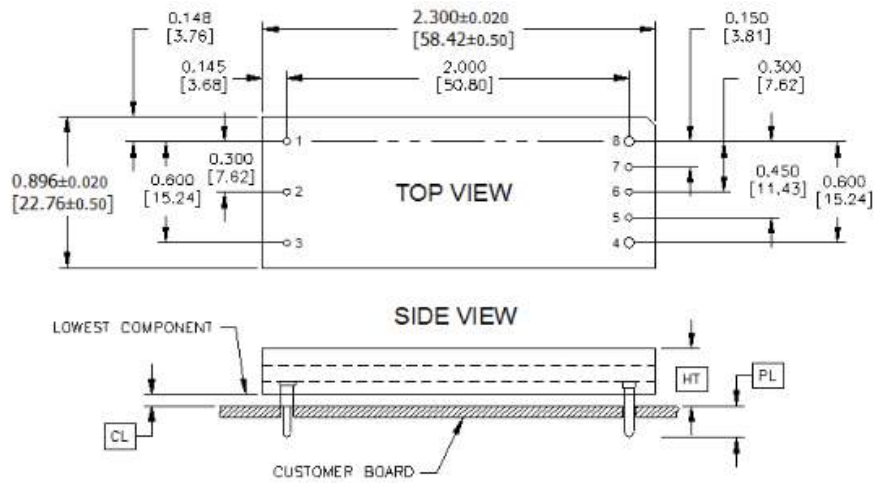

Figure 19.  $V_{in-}$  EMI waveform

5. MECHANICAL PARAMETERS



SQE48T Pinout (Through-hole)

SQE48T Platform Notes

- All dimensions are in inches [mm]
- Pins 1-3 and 5-7 are Ø 0.040" [1.02] with Ø 0.078" [1.98] shoulder
- Pins 4 and 8 are Ø 0.062" [1.57] without shoulder
- Pin Material & Finish: Brass Alloy 360 ½ Hard with Matte Tin/Lead over Nickel or Copper Alloy CDA 145 with Matte Tin over Nickel (RoHS Option)
- Converter Weight: 0.72 oz [20.6 g]

PAD/PIN CONNECTIONS	
Pad/Pin #	Function
1	Vin (+)
2	ON/OFF
3	Vin (-)
4	Vout (-)
5	SENSE(-)
6	TRIM
7	SENSE(+)
8	Vout (+)

Height Option	HT	CL
	(Max. Height)	(Min. Clearance)
	+0.000 [+0.00]	+0.016 [+0.41]
	-0.038 [- 0.97]	-0.000 [- 0.00]
G	0.407 [10.34]	0.035 [0.89]

Pin Option	PL
	Pin Length
	±0.005 [±0.13]
A	0.188 [4.77]
B	0.145 [3.68]

6. ORDERING INFORMATION

Product Series <sup>1</sup>	Input Voltage	Mounting Scheme	Rated Load Current	Output Voltage	ON/OFF Logic	Maximum Height [HT]	Pin Length [PL]	Special Features	RoHS
SQE	48	T	20	033	- N	G	B	0	G
1/8 <sup>th</sup> Brick Format	36-75 V	T⇒ Through-hole	20 A	033 ⇒ 3.3 V	N ⇒ Negative P ⇒ Positive	Through hole G ⇒ 0.188" 0.407"	Through hole A ⇒ 0.188" B ⇒ 0.145"	0 ⇒ STD	No Suffix ⇒ RoHS lead-solder-exemption compliant G ⇒ RoHS compliant for all six substances

The example above describes P/N SQE48T20033-NGB0G: 36-75V input, through-hole mounting, 20A @ 3.3V output, negative ON/OFF logic, a maximum height of 0.407", and a through the board pin length of 0.145", and RoHS compliant. Please consult factory regarding availability of a specific (including RoHS compliant) version.

For more information on these products consult: [tech.support@psbel.com](mailto:tech.support@psbel.com)

**NUCLEAR AND MEDICAL APPLICATIONS** - Products are not designed or intended for use as critical components in life support systems, equipment used in hazardous environments, or nuclear control systems.

**TECHNICAL REVISIONS** - The appearance of products, including safety agency certifications pictured on labels, may change depending on the date manufactured. Specifications are subject to change without notice.



Asia-Pacific  
+86 755 298 85888

Europe, Middle East  
+353 61 225 977

North America  
+1 408 785 5200