

MAX40010

76V Precision, High-Voltage, Current-Sense Amplifier

General Description

The MAX40010 single-channel, high-side precision current-sense amplifier with an input common-mode voltage range from 2.7V to 76V, making it ideal for communications, automotive, data centers and other systems where high-voltage current monitoring is critical. The MAX40010 offer accuracy specifications of less than 12 μ V (max) Input Offset voltage and less than 0.1% (max) gain error. By offering precision offset and gain error specifications, the MAX40010 makes it possible to sense very small sense/shunt resistors, further improving system efficiencies and power dissipation through the sense element.

The MAX40010 features 80kHz of small signal bandwidth and four unique gain options (12.5V/V, 20V/V, 50V/V, and 100V/V). The device's current-sense inputs have EMIR filters to reject RF found in communications equipment.

The MAX40010 operates over the -40 $^{\circ}$ C to + 125 $^{\circ}$ C temperature range and is offered in a 6-bump, 1mm x 1.5mm wafer-lever package (WLP) with 0.5mm pitch and a SOT23 U6SN+1 package.

Benefits and Features

- Input Common Mode +2.7V to +76V
- Ultra-Tiny 1mm x 1.5mm 6-bump WLP and SOT23 Packages
- Low 12 μ V (max) Input Offset Voltage
- Low 0.1% (max) Gain Error
- Available Gain Options:
 - G = 12.5V/V: MAX40010L
 - G = 20V/V: MAX40010T
 - G = 50V/V: MAX40010F
 - G = 100V/V: MAX40010H

Applications

- Base-Station and Communication Equipment
- Server Backplanes/Data Centers
- Automotive Sensing
- Energy Management
- Solar Panel Monitoring

Ordering Information appears at end of data sheet.

Typical Operating Circuit

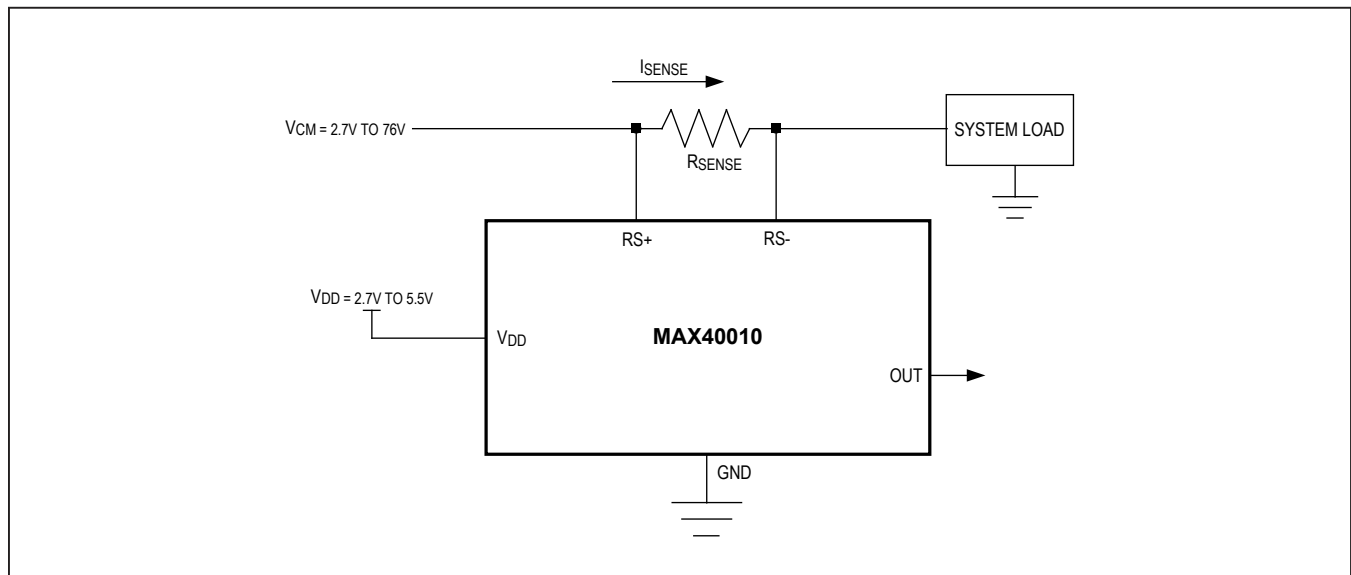

Absolute Maximum Ratings

V _{DD} to GND	-0.3V to +6.0V	Operating Temperature Range.....	-40°C to +125°C
RS+, RS- to GND	-0.3V to +80V	Junction Temperature.....	+150°C
RS+ to RS- (Continuous)	±24V	Storage Temperature Range.....	-65°C to +150°C
Continuous (> 1s) Input Current (Any Pin).....	±10mA	Reflow Soldering Peak Temperature (Pb-free)	+260°C

Package Thermal Characteristics (Note 1)

6-Bump WLP		6-Pin SOT23	
Continuous Power Dissipation (Derate mW/°C above +70°C).....	12.34mW	Continuous Power Dissipation (Derate mW/°C above +70°C).....	13.40mW
Junction-to-Ambient Thermal Resistance (θ _{JA})	81.03°C/W	Junction-to-Ambient Thermal Resistance (θ _{JA})	74.60°C/W
		Junction-to-Case Thermal Resistance (θ _{JC}).....	6.0°C/W

Note 1: Package thermal resistances were obtained using the method described in JEDEC specification JESD51-7, using a four-layer board. For detailed information on package thermal considerations, refer to www.maximintegrated.com/thermal-tutorial.

Stresses beyond those listed under "Absolute Maximum Ratings" may cause permanent damage to the device. These are stress ratings only, and functional operation of the device at these or any other conditions beyond those indicated in the operational sections of the specifications is not implied. Exposure to absolute maximum rating conditions for extended periods may affect device reliability.

Electrical Characteristics

(V_{RS+} = V_{RS-} = +36V, V_{DD} = +3.3V, V_{SENSE} = V_{RS+} - V_{RS-} = 1mV, T_A = -40°C to +125°C unless otherwise noted. Typical values are at T_A = +25°C.) (Note 2)

PARAMETER	SYMBOL	CONDITIONS	MIN	TYP	MAX	UNITS
DC CHARACTERISTICS						
Supply Voltage	V _{DD}	Guaranteed by PSRR	2.7		5.5	V
Supply Current	I _{DD}	T _A = +25°C		350		µA
		-40°C < T _A < +125°C			800	
Power-Supply Rejection Ratio	PSRR	2.7V ≤ V _{DD} ≤ 5.5V	110	120		dB
Input Common-Mode Voltage Range	V _{CM}	Guaranteed by CMRR	2.7		76	V
Input Bias Current at V _{RS+} and V _{RS-}	I _{RS+} , I _{RS-}				65	µA
Input Offset Current	I _{RS+} - I _{RS-}				400	nA
Input Leakage Current	I _{RS+} , I _{RS-}	V _{DD} = 0V, V _{RS+} = 76V			5	µA
Common-Mode Rejection Ratio	CMRR	+4.5V < V _{RS+} < +76V	125	140		dB
Input Offset Voltage	V _{OS}	T _A = +25°C			±12	µV
		-40°C ≤ T _A ≤ +85°C			±25	
		-40°C ≤ T _A ≤ +125°C			±25	
Input Offset Voltage Drift	TCV _{OS}				130	nV/°C
Input Sense Voltage	V _{SENSE}	MAX40010L (G = 12.5V/V)		200		mV
		MAX40010T (G = 20V/V)		125		
		MAX40010F (G = 50V/V)		50		
		MAX40010H (G = 100V/V)		25		

Electrical Characteristics (continued)

($V_{RS+} = V_{RS-} = +36V$, $V_{DD} = +3.3V$, $V_{SENSE} = V_{RS+} - V_{RS-} = 1mV$, $T_A = -40^{\circ}C$ to $+125^{\circ}C$ unless otherwise noted. Typical values are at $T_A = +25^{\circ}C$.) (Note 2)

PARAMETER	SYMBOL	CONDITIONS	MIN	TYP	MAX	UNITS
Gain (Note 3)	G	Full-Scale $V_{SENSE} = 200mV$		12.5		V/V
		Full-Scale $V_{SENSE} = 125mV$		20		
		Full-Scale $V_{SENSE} = 50mV$		50		
		Full-Scale $V_{SENSE} = 25mV$		100		
Gain Error	GE	$T_A = +25^{\circ}C$			0.1	%
		$-40^{\circ}C \leq T_A \leq +85^{\circ}C$			0.5	
		$-40^{\circ}C \leq T_A \leq +125^{\circ}C$			0.7	
Output Resistance	R_{OUT}			0.1		m Ω
Output Low Voltage	V_{OL}	Sink 500 μA			15	mV
Output High Voltage	V_{OH}	Source 500 μA	$V_{DD} - 0.016$			V
AC CHARACTERISTICS						
Signal Bandwidth	BW -3dB	Gain = 50V/V Configuration $V_{SENSE} > 5mV$		80		kHz
AC Power Supply Rejection Ratio	AC PSRR	$f = 200kHz$		40		dB
AC CMRR	AC CMRR	$f = 200kHz$		48		dB
Output Transient Recovery Time		$\Delta V_{OUT} = 2V_{P-P}$, 0.1% final V_{OUT} settling with 400 Ω and 1nF onto 6pF ADC input sampling capacitor		2		μs
Capacitive Load Stability	C_{LOAD}	With 240 Ω isolation resistor		20		nF
		Without any isolation resistor		200		pF
Input Voltage Noise Density	e_n	$f = 1kHz$		65		nV/ \sqrt{Hz}
Total Harmonic Distortion	THD	$f = 1kHz$, $V_{OUT} = 1V_{P-P}$		60		dB
Power-Up Time (Note 4)				200		μs
Saturation Recovery Time				10		μs

Note 2: All devices are 100% production tested at $T_A = +25^{\circ}C$. All temperature limits are guaranteed by design.

Note 3: Gain and offset voltage are calculated based on two point measurements: $V_{SENSE1} = 20\%$ full scale and $V_{SENSE2} = 80\%$ full scale.

Note 4: Output is high-Z during power-up.

Typical Operating Characteristics

($V_{RS+} = V_{RS-} = +36V$, $V_{DD} = +3.3V$, $V_{SENSE} = V_{RS+} - V_{RS-} = 1mV$, $T_A = -40^{\circ}C$ to $+125^{\circ}C$, unless otherwise noted. Typical values are at $T_A = +25^{\circ}C$.)

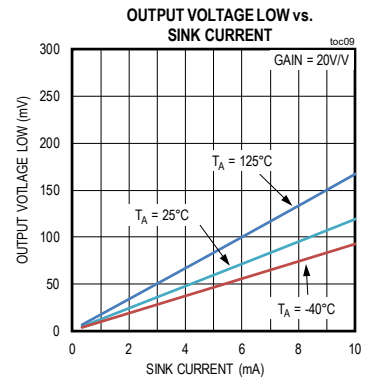
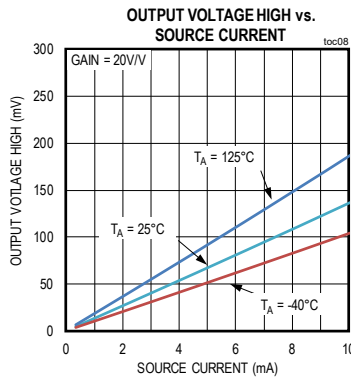
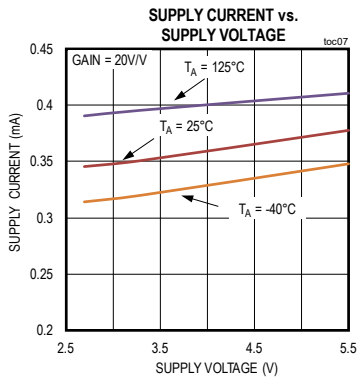
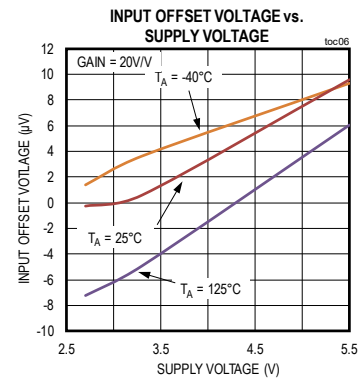
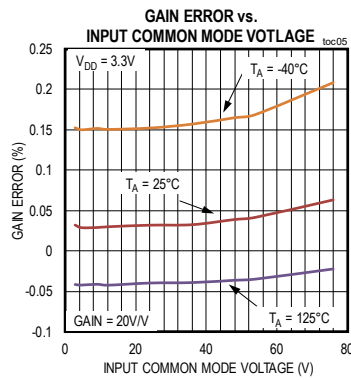
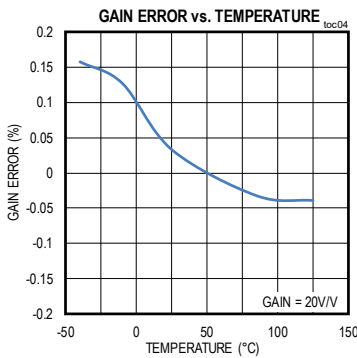
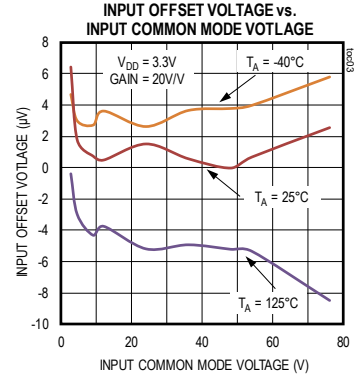
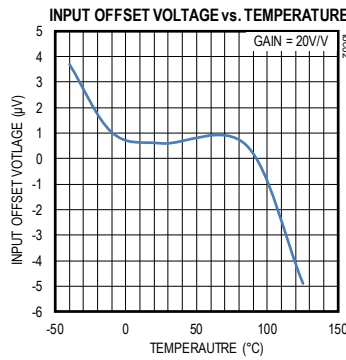
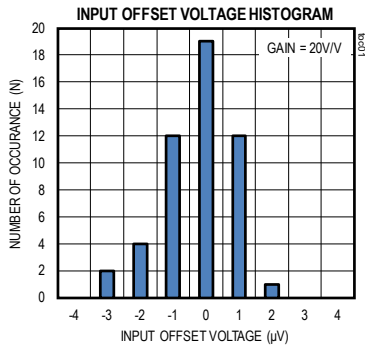

Typical Operating Characteristics (continued)

($V_{RS+} = V_{RS-} = +36V$, $V_{DD} = +3.3V$, $V_{SENSE} = V_{RS+} - V_{RS-} = 1mV$, $T_A = -40^{\circ}C$ to $+125^{\circ}C$, unless otherwise noted. Typical values are at $T_A = +25^{\circ}C$.)

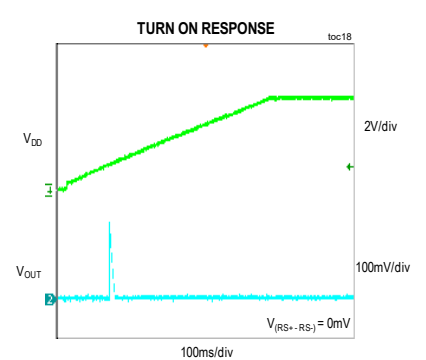
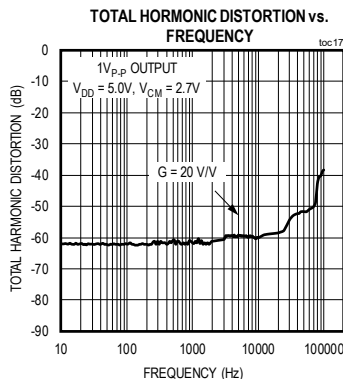
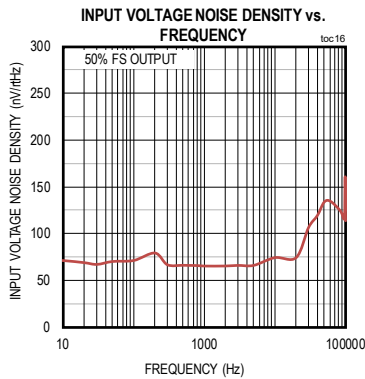
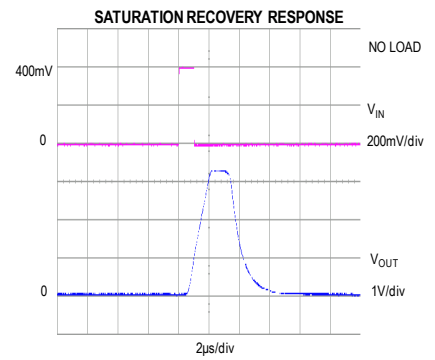
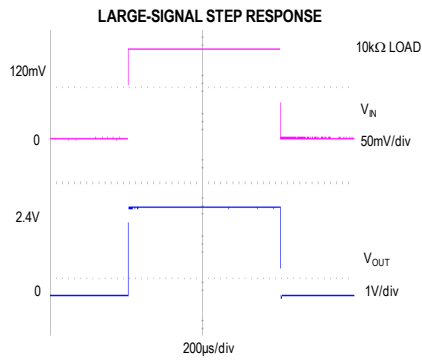
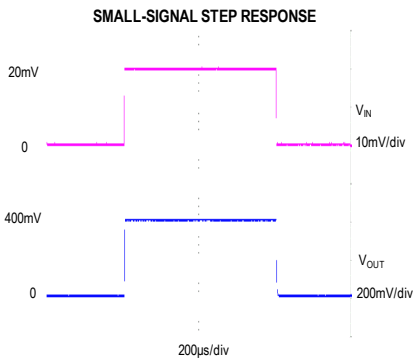
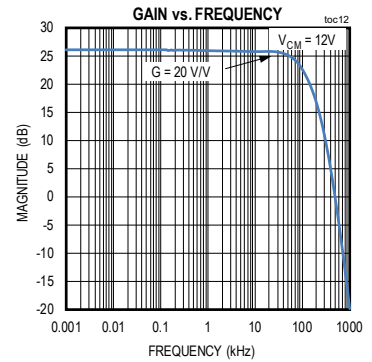
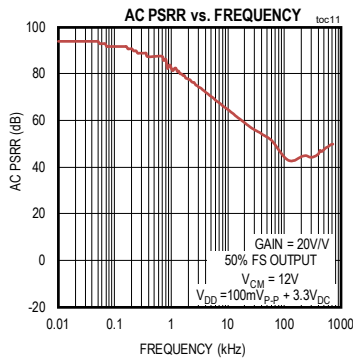
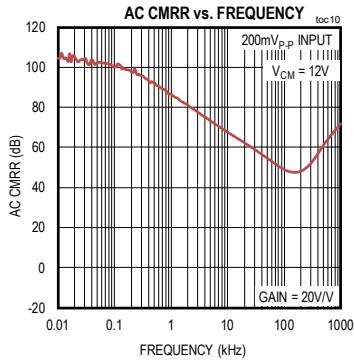

Typical Operating Characteristics (continued)

($V_{RS+} = V_{RS-} = +36V$, $V_{DD} = +3.3V$, $V_{SENSE} = V_{RS+} - V_{RS-} = 1mV$, $T_A = -40^{\circ}C$ to $+125^{\circ}C$, unless otherwise noted. Typical values are at $T_A = +25^{\circ}C$.)

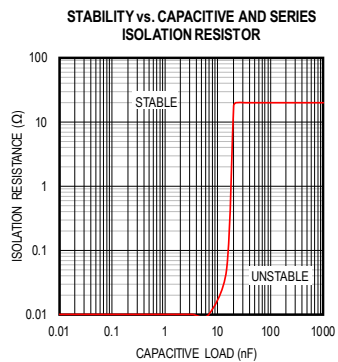
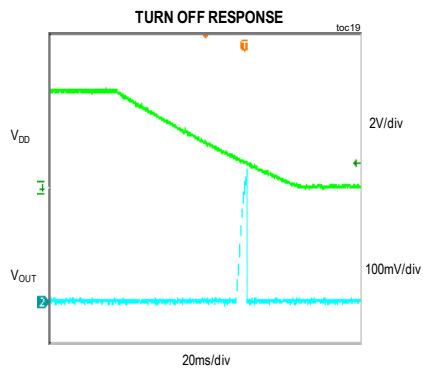

Pin Configurations

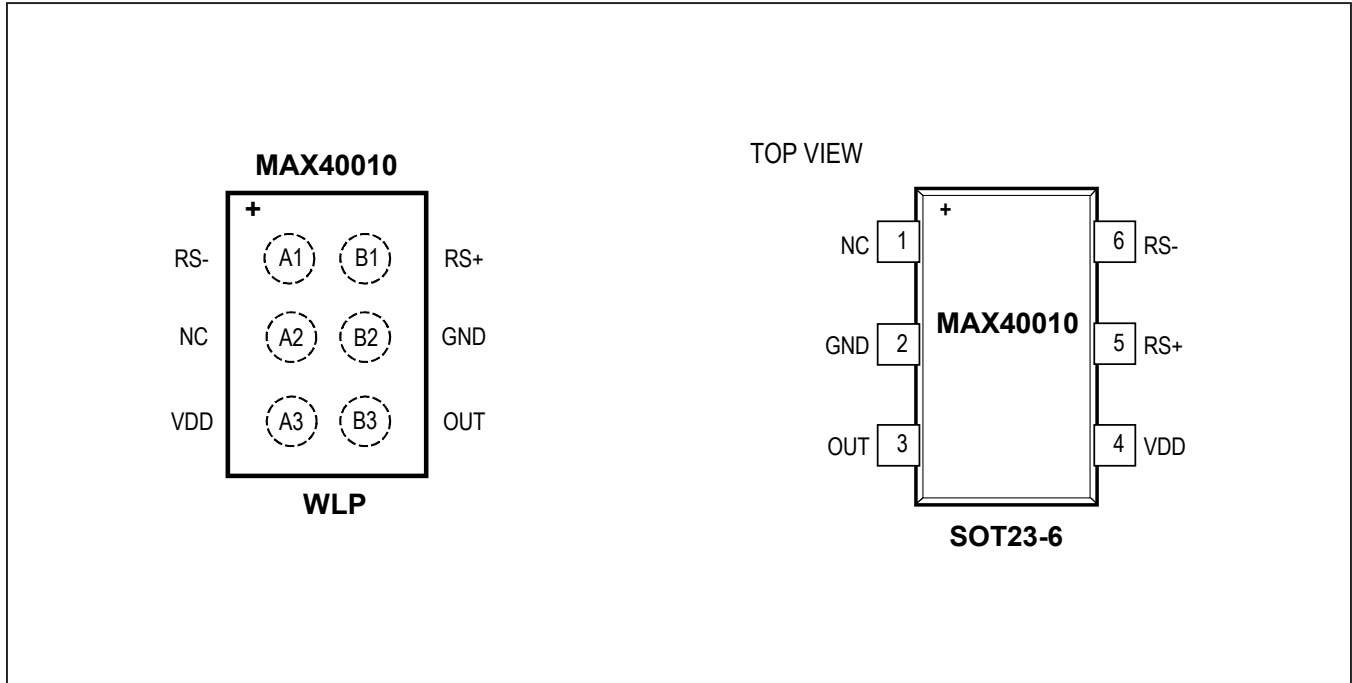

Pin Description

PIN		NAME	FUNCTION
WLP	SOT23		
B1	5	RS+	External Resistor Power-Side Connection Input
A1	6	RS-	External Resistor Load-Side Connection Input
A3	4	VDD	Supply Voltage Input
B2	2	GND	Ground or Supply Return Input
B3	3	OUT	Output. Output is proportional to the magnitude of differential sense input voltage.
A2	1	NC	No Connect.

Functional (or Block) Diagram

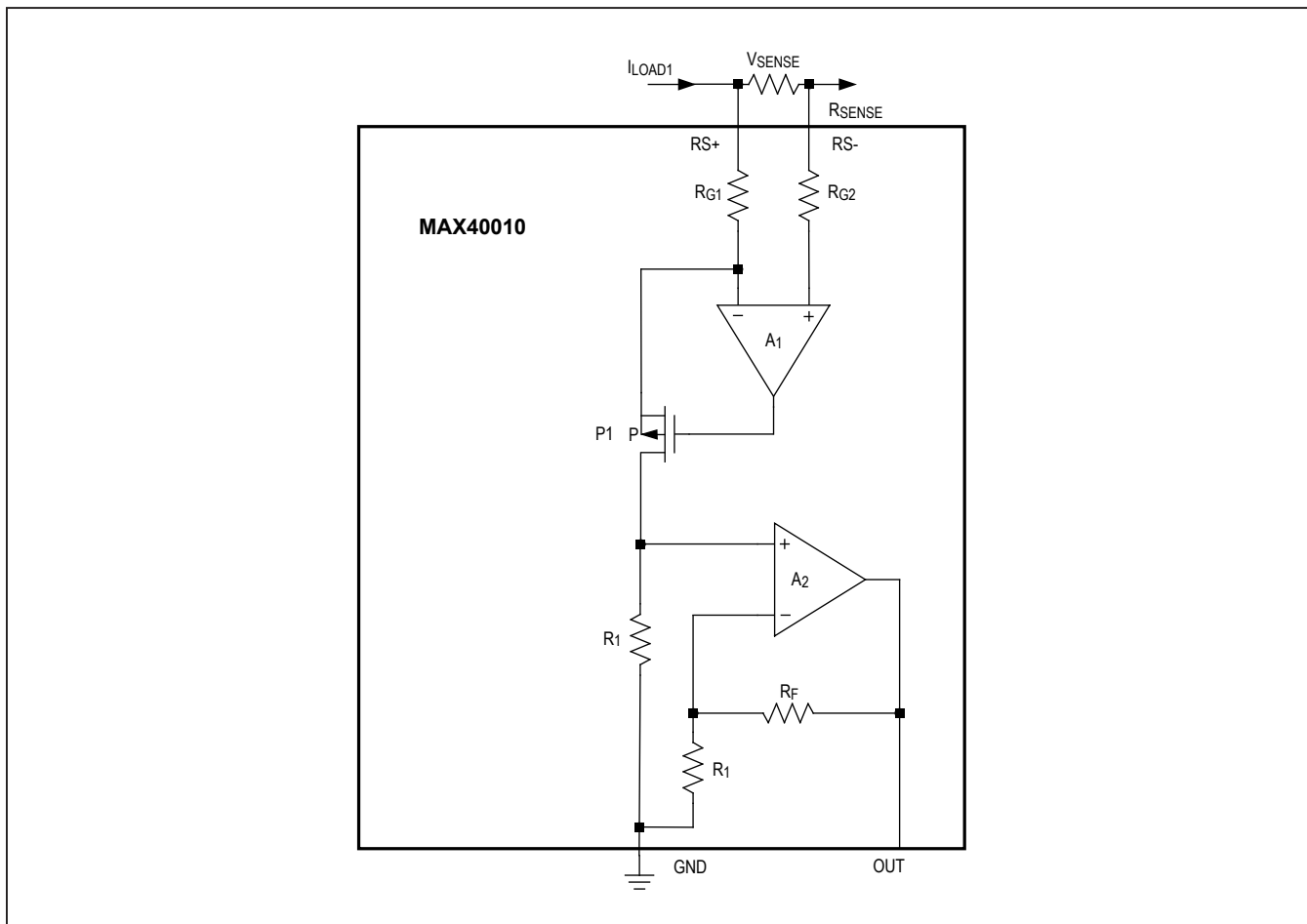

Figure 1. MAX40010 Functional Diagram

Detailed Description

The MAX40010 high-side, current-sense amplifier features a 2.7V to 76V input common-mode range that is independent of supply voltage. This feature allows the monitoring of current out of a battery as low as 2.7V and enables high-side current sensing at voltages greater than the supply voltage (V_{DD}). The MAX40010 monitors current through an external current-sense resistor and amplifies the voltage across the resistor.

High-side current monitoring does not interfere with the ground path of the load being measured, making the MAX40010 particularly useful in a wide range of high-voltage systems.

The MAX40010 operates as follows: current from the source flows through R_{SENSE} to the load (Figure 1), creating a sense voltage, V_{SENSE} . The internal op amp A1 force the current through an internal gain resistor $RG1$ at $RS+$ input, such that its voltage drop equals the voltage drop (V_{SENSE}) across the external sense resistors (R_{SENSE}). The internal resistor at $RS-$ input ($RG2$) has the same value as $RG1$ to minimize the error. The current through $RG1$ is sourced by a high-voltage p-channel FET. Its source current is the same as the drain current which flows through a second gain resistor, $R1$, producing a voltage $VR1 = V_{SENSE} \times R1 / RG1$.

The output voltage V_{OUT} is produced from a second op amp A2 with the gain $(1 + RF1 / R1)$. Hence the $V_{OUT} = I_{LOAD} \times R_{SENSE} (R1 / RG1) \times (1 + RF1 / R1)$. The value of internal resistors $R1$, $R2$, $RG1$, $RG2$, RF are available in Table 1.

Total gain is 12.5V/V for MAX40010L, 20V/V for the MAX40010T, 50V/V for the MAX40010F, and 100V/V for the MAX40010H.

Table 1. Internal Gain-Setting Resistors

	GAIN (V/V)	R1, R2 (kΩ)	RG1, RG2 (kΩ)	RF (kΩ)
MAX40010L	12.5	25	10	100
MAX40010T	20	25	10	175
MAX40010F	50	25	10	475
MAX40010H	100	25	10	975

Application Information

Recommended Component Values

Ideally, the maximum load current develops the full-scale sense voltage across the current-sense resistor. Choose the gain needed to yield the maximum output voltage required for the application:

$$V_{OUT} = V_{SENSE} \times AV$$

where V_{SENSE} is the full-scale sense voltage, 200mV for gain of 12.5V/V, 125mV for gain of 20V/V, 50mV for gain of 50V/V, 25mV for gain of 100V/V, and AV is the gain of the device.

In applications monitoring a high current, ensure that R_{SENSE} is able to dissipate its own I^2R loss. If the resistor's power dissipation exceeds the nominal value, its value may drift or it may fail altogether.

The MAX40010 sense a wide variety of currents with different sense-resistor values.

Choosing the Sense Resistor

Choose R_{SENSE} based on the following criteria:

- **Voltage Loss:** A high R_{SENSE} value causes the power-source voltage to degrade through IR loss. For minimal voltage loss, use the lowest R_{SENSE} value.
- **Accuracy:** A high R_{SENSE} value allows lower currents measured more accurately. This is due to offsets becoming less significant when the sense voltage is larger. For best performance, select R_{SENSE} to provide approximately 200mV (gain of 12.5V/V), 125mV (gain of 20V/V), or 50mV (gain of 50V/V), 25mV (gain of 100V/V) of sense voltage for the full-scale current in each application.

• **Efficiency and Power Dissipation:** At high current levels, the I^2R losses in R_{SENSE} can be significant. Consider this when choosing the resistor value and its power dissipation (wattage) rating. In addition, the sense resistor's value might drift if it heats up excessively.

• **Inductance:** Keep inductance low if I_{SENSE} has a large high-frequency component. Wire-wound resistors have the highest inductance, while metal film is somewhat better. Low-inductance, metal-film resistors are also available. Instead of being spiral wrapped around a core, as in metal-film or wire wound resistors, they are a straight band of metal and are available in values under 1Ω .

Take care to eliminate parasitic trace resistance from causing errors in the sense voltage because of the high currents that flow through R_{SENSE} . Either use a four-terminal current-sense resistor or use Kelvin (force and sense) PC board layout techniques.

EMIRR Input Filter

These devices have input EMI filters to prevent effects of radio frequency interference on the output. The EMI filters comprise passive devices that present significant higher impedance to RF signals. See the EMIRR vs. Frequency plot in the *Typical Operating Characteristics* section for details.

Typical Application Circuit

An example of typical application (Figure 2) of this high-voltage, high-precision current-sense amplifier is in base station systems where there is a need to monitor the current flowing in the power amplifier. Such an amplifier, depending on the technology, can be biased up to 50V or 60V thus requiring a current-sense amplifier like the MAX40010 with high voltage common mode. The very low input offset voltage of the MAX40010 minimizes the value of the external sense resistor, resulting in system power saving.

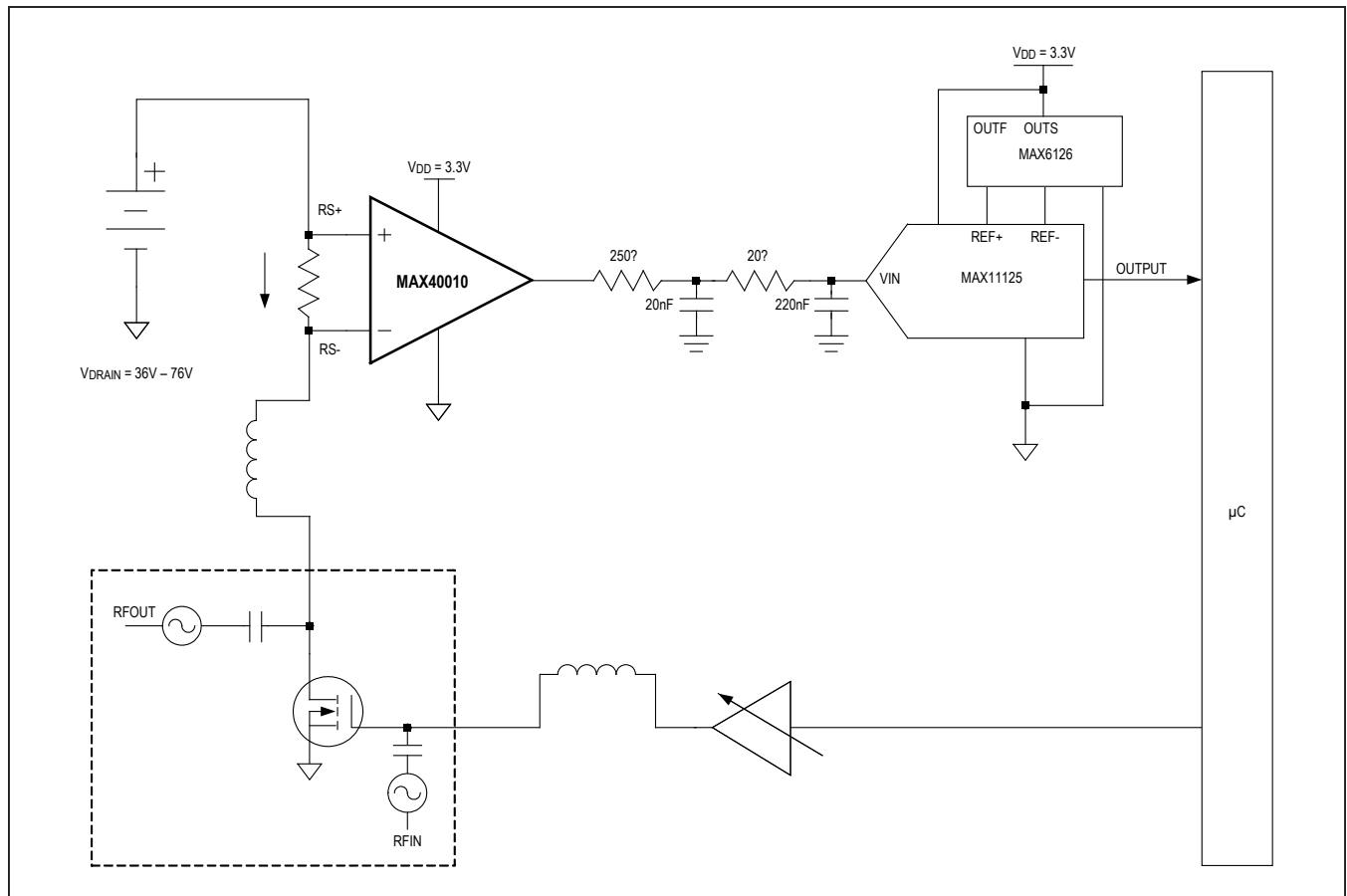

Figure 2. MAX40010 Used in Base Station Application

Turn On/Off Response

The internal POR (Power on Reset) structure creates the inadvertent glitch, as shown in TOC18 and TOC19: typical turn on and turn off response of MAX40010. The internal POR event takes place below minimum V_{CC} supply voltage (2.7V) around 1.7V. During this event the bias generators are defined, the internal blocks are set to known state and as a result, an output (V_{OUT}) glitch is observed. The device may take tens of μs to settle to final value during power on and less than 10ms to settle during turn off.

Output Filtering

To avoid output noise and transient overshoot, an RC filter with $R = 500\Omega$ and $C_L = 14.7nF$ at the output is recommended (Figure 3). This also benefits when the current sense amplifier is connected to a sample and hold ADC's, where the C_L will act as a charge reservoir during sample phase. when choosing different values of R and C_L , refer to TOC20 (Stability vs. Isolation Resistance and Capacitive Load) for more information.

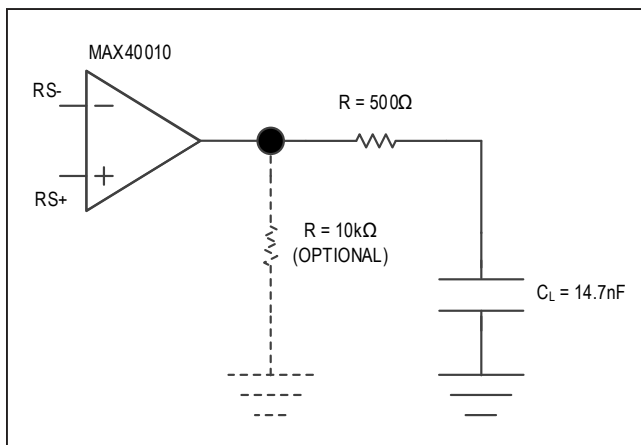

Figure 3. Optional Output Filtering

Ordering Information

PART	GAIN (V/V)	TEMP RANGE	PIN-PACKAGE	TOP MARK
MAX40010LAUT+	12.5	-40°C to +125°C	6 SOT23	+ACUR
MAX40010LAUT+T	12.5	-40°C to +125°C	6 SOT23	+ACUR
MAX40010LAWT+	12.5	-40°C to +125°C	6 WLP	+DX
MAX40010LAWT+T	12.5	-40°C to +125°C	6 WLP	+DX
MAX40010TAUT+	20	-40°C to +125°C	6 SOT23	+ACUS
MAX40010TAUT+T	20	-40°C to +125°C	6 SOT23	+ACUS
MAX40010TAWT+*	20	-40°C to +125°C	6 WLP	+DY
MAX40010TAWT+T*	20	-40°C to +125°C	6 WLP	+DY
MAX40010FAUT+	50	-40°C to +125°C	6 SOT23	+ACUT
MAX40010FAUT+T	50	-40°C to +125°C	6 SOT23	+ACUT
MAX40010FAWT+*	50	-40°C to +125°C	6 WLP	+DV
MAX40010FAWT+T*	50	-40°C to +125°C	6 WLP	+DV
MAX40010HAUT+	100	-40°C to +125°C	6 SOT23	+ACUU
MAX40010HAUT+T	100	-40°C to +125°C	6 SOT23	+ACUU
MAX40010HAWT+*	100	-40°C to +125°C	6 WLP	+DW
MAX40010HAWT+T*	100	-40°C to +125°C	6 WLP	+DW

*Future product—contact factory for availability.

+Denotes a lead(Pb)-free/RoHS-compliant package.

T = tape and reel.

Package Information

For the latest package outline information and land patterns (footprints), go to www.maximintegrated.com/packages. Note that a "+", "#", or "-" in the package code indicates RoHS status only. Package drawings may show a different suffix character, but the drawing pertains to the package regardless of RoHS status.

PACKAGE TYPE	PACKAGE CODE	OUTLINE NO.	LAND PATTERN NO.
6 WLP	W61K1+1	21-100121	Refer to Application Note 1891
6 SOT23	U6SN+1	21-0058	91-0175

Revision History

REVISION NUMBER	REVISION DATE	DESCRIPTION	PAGES CHANGED
0	7/17	Initial release	—
1	10/17	Changed future product status for MAX40010LAUT+, MAX40010TAUT+, and MAX40010HAUT+ in <i>Ordering Information</i> table	10
2	1/18	Added TOCs 18–20, added “Turn On/Off” and “Output Filtering” sections, and Figure 3	5, 6, 9, 10
3	10/18	Updated <i>Ordering Information</i>	12
4	7/20	Updated <i>Ordering Information</i>	12
5	10/20	Updated <i>EC Table</i>	3

For pricing, delivery, and ordering information, please visit Maxim Integrated's online storefront at <https://www.maximintegrated.com/en/storefront/storefront.html>.

Maxim Integrated cannot assume responsibility for use of any circuitry other than circuitry entirely embodied in a Maxim Integrated product. No circuit patent licenses are implied. Maxim Integrated reserves the right to change the circuitry and specifications without notice at any time. The parametric values (min and max limits) shown in the Electrical Characteristics table are guaranteed. Other parametric values quoted in this data sheet are provided for guidance.