

## YASMEEN-30-RS

~11° spot beam

### SPECIFICATION:

Dimensions	Ø 29.7 mm
Height	18.2 mm
ROHS compliant	yes ⓘ

### MATERIALS:

Component	Type	Material	Colour	Finish
YASMEEN-30-RS	Single lens	PMMA	clear	



### ORDERING INFORMATION:

Component	Qty in box	MOQ	MPQ	Box weight (kg)
C17180_YASMEEN-30-RS » Box size: 480 x 280 x 300 mm	792	132	66	5.1

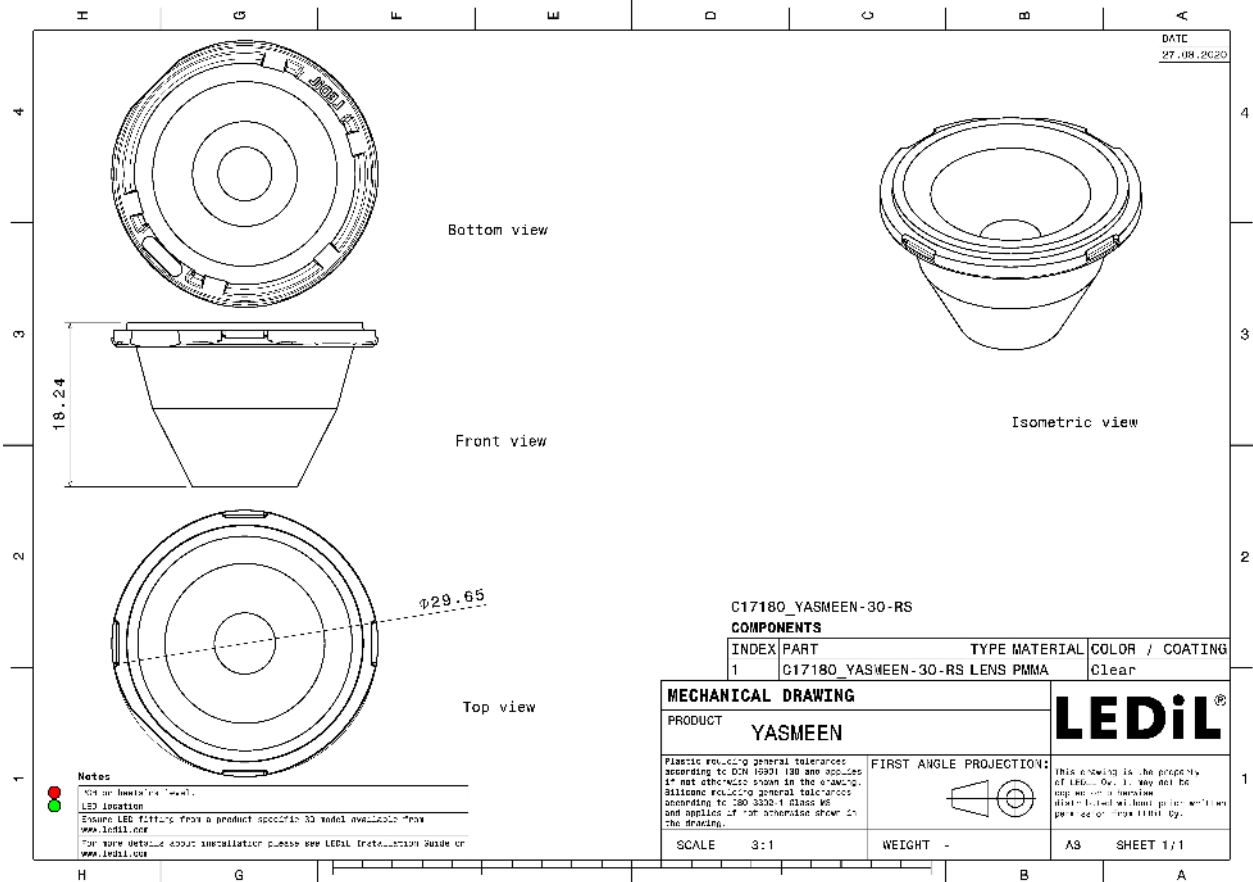





See also our general installation guide: [www.ledil.com/installation\\_guide](http://www.ledil.com/installation_guide)

### OPTICAL RESULTS (MEASURED):

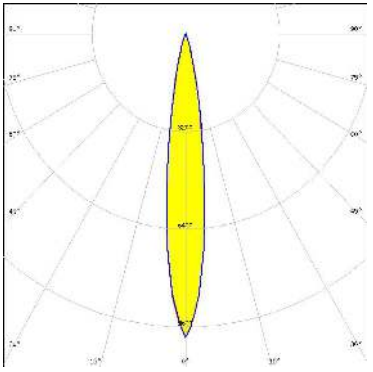

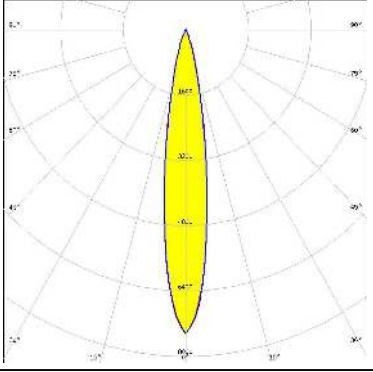
#### OPTICAL RESULTS (SIMULATED):

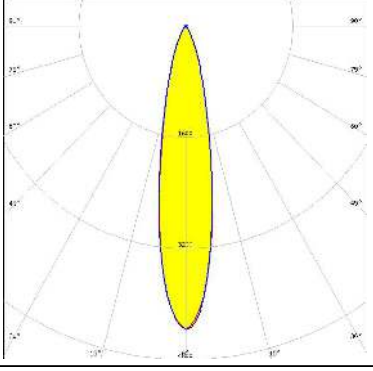
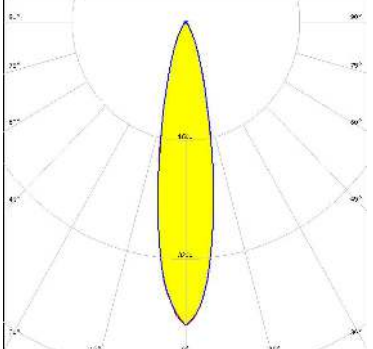
<p></p> <p>LED V3 HD Gen 8</p> <p>FWHM / FWTM 14.0° / 30.0°</p> <p>Efficiency 95 %</p> <p>Peak intensity 10 cd/lm</p> <p>LEDs/each optic 1</p> <p>Light colour White</p> <p>Required components:</p>	
<p></p> <p>LED V4 HD Gen 7</p> <p>FWHM / FWTM 16.0° / 34.0°</p> <p>Efficiency 94 %</p> <p>Peak intensity 7.5 cd/lm</p> <p>LEDs/each optic 1</p> <p>Light colour White</p> <p>Required components:</p>	
<p></p> <p>LED V6 HD Gen 7</p> <p>FWHM / FWTM 20.0° / 46.0°</p> <p>Efficiency 93 %</p> <p>Peak intensity 4.4 cd/lm</p> <p>LEDs/each optic 1</p> <p>Light colour White</p> <p>Required components:</p>	
<p><b>CITIZEN</b></p> <p>LED CLU700/701/702/703</p> <p>FWHM / FWTM 22.0° / 48.0°</p> <p>Efficiency 93 %</p> <p>Peak intensity 4.1 cd/lm</p> <p>LEDs/each optic 1</p> <p>Light colour White</p> <p>Required components:</p>	

#### OPTICAL RESULTS (SIMULATED):

#### CITIZEN

LED CLU710/711  
 FWHM / FWTM 24.0° / 60.0°  
 Efficiency 87 %  
 Peak intensity 2.2 cd/lm  
 LEDs/each optic 1  
 Light colour White  
 Required components:

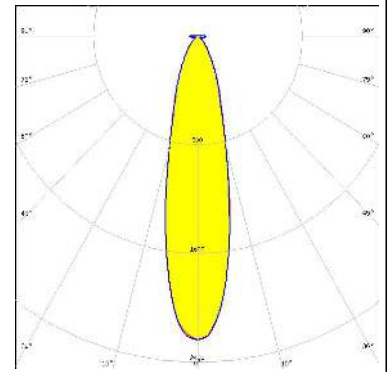

#### CITIZEN

LED CLU7A2/7A3  
 FWHM / FWTM 18.0° / 34.0°  
 Efficiency 94 %  
 Peak intensity 7.3 cd/lm  
 LEDs/each optic 1  
 Light colour White  
 Required components:

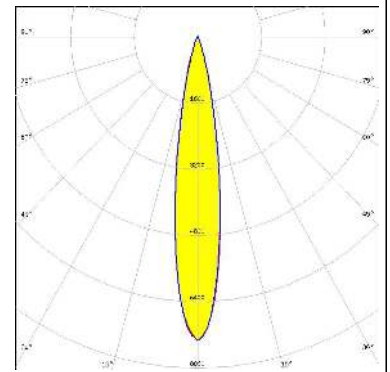

#### CITIZEN

LED CLU7B2  
 FWHM / FWTM 14.0° / 29.0°  
 Efficiency 95 %  
 Peak intensity 10.4 cd/lm  
 LEDs/each optic 1  
 Light colour White  
 Required components:

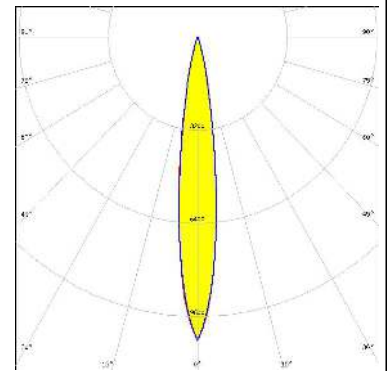





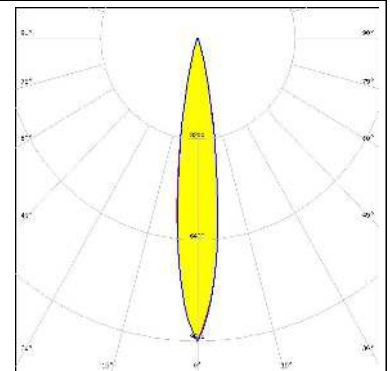

#### CITIZEN

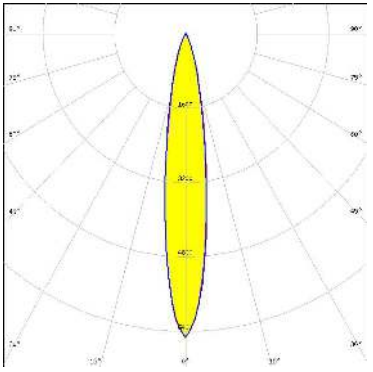

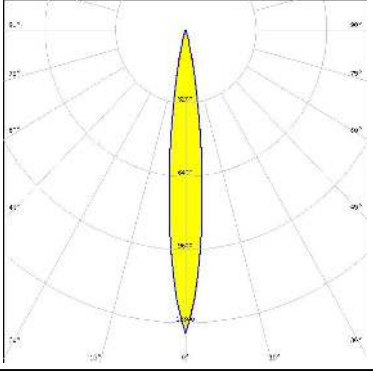

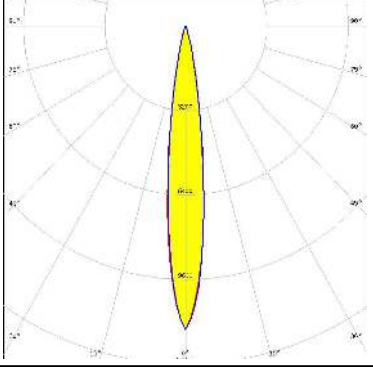

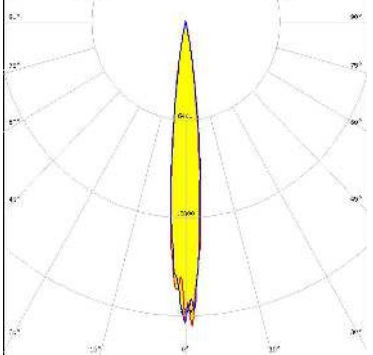
LED CLU7S3  
 FWHM / FWTM 16.0° / 30.0°  
 Efficiency 92 %  
 Peak intensity 9.6 cd/lm  
 LEDs/each optic 1  
 Light colour White  
 Required components:

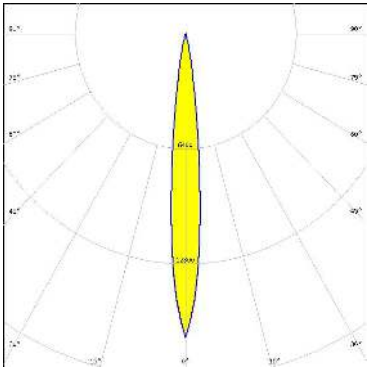

#### OPTICAL RESULTS (SIMULATED):

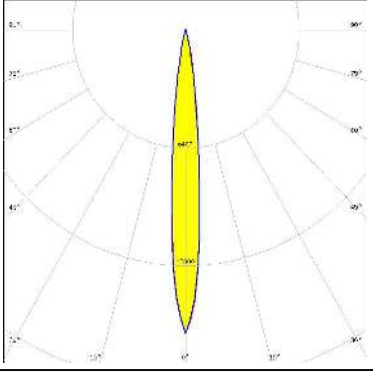
	<p>LED: CMA1303            FWHM / FWTM: 16.0° / 38.0°            Efficiency: 94 %            Peak intensity: 6.5 cd/lm            LEDs/each optic: 1            Light colour: White            Required components:</p>	
	<p>LED: XHP35 HI            FWHM / FWTM: 14.0° / 26.0°            Efficiency: 95 %            Peak intensity: 13.3 cd/lm            LEDs/each optic: 1            Light colour: White            Required components:</p>	
	<p>LED: XM-L            FWHM / FWTM: 14.0° / 28.0°            Efficiency: 94 %            Peak intensity: 11.5 cd/lm            LEDs/each optic: 1            Light colour: White            Required components:</p>	
	<p>LED: XP-G2            FWHM / FWTM: 11.4° / 20.8°            Efficiency: 92 %            Peak intensity: 22.7 cd/lm            LEDs/each optic: 1            Light colour: White            Required components:</p>	

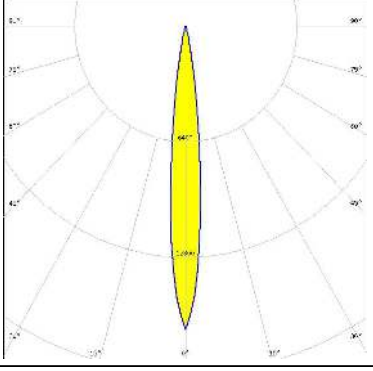
#### OPTICAL RESULTS (SIMULATED):

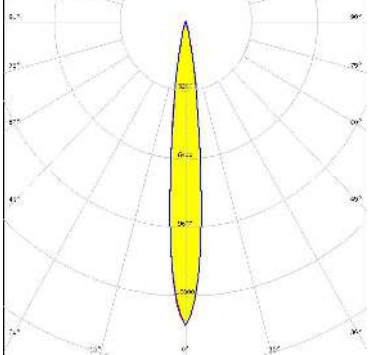
	<p>LED: XP-L HI            FWHM / FWTM: 12.0° / 22.0°            Efficiency: 95 %            Peak intensity: 16.9 cd/lm            LEDs/each optic: 1            Light colour: White            Required components:</p>	
	<p>LED: NCSxE17A            FWHM / FWTM: 10.0° / 22.0°            Efficiency: 92 %            Peak intensity: 16.5 cd/lm            LEDs/each optic: 1            Light colour: White            Required components:</p>	
	<p>LED: NVSW719AC            FWHM / FWTM: 12.0° / 22.0°            Efficiency: 95 %            Peak intensity: 16.8 cd/lm            LEDs/each optic: 1            Light colour: White            Required components:</p>	
	<p>LED: NVSxE21A            FWHM / FWTM: 12.0° / 24.0°            Efficiency: 93 %            Peak intensity: 14.2 cd/lm            LEDs/each optic: 1            Light colour: White            Required components:</p>	

### GENERAL INFORMATION:

NOTE: The typical beam angle will be changed by different color, chip size and chip position tolerance. The typical total beam angle is the full angle measured where the luminous intensity is half of the peak value.

Due to use of high power COB's with this product, special attention to proper thermal design is highly recommended. LEDiL has no liability for direct, indirect or consecutive damages arising from the LEDiL products being used outside of the recommended temperature range.

### MATERIALS:

As part of our continuous research and improvement processes, and to ensure the best possible quality and availability of our products, LEDiL reserves the right to change material grades without notice.

### PRODUCT DATA USER AGREEMENT AND DISCLAIMER:

The measured data in the provided downloadable LEDiL Product Datasheets and Mechanical 2D-Drawings is rounded and provided as reference for planning. LEDiL Oy's optical specifications have been verified by conducting performance testing of the products in accordance with the company's quality system. The reported data are averaged results of multiple measurements with typical variation. LEDiL Oy reserves the right to without prior notification make changes and improvements to its products.

LEDiL Oy assumes neither warranty, nor guarantee nor any other liability of any kind for the contents and correctness of the provided data. The provided data has been generated with highest diligence but the provided data may in reality not represent the complete possible variation range of all intrinsic parameters. Therefore, in certain cases a deviation from the provided data could occur.

LEDiL Oy reserves the right to undertake technical changes of its products without further notification which could lead to changes in the provided data. LEDiL Oy assumes no liability of any kind for the possible deviation from any provided data or any other damage resulting from the usage of the provided data.

The user agrees to this disclaimer and user agreement with the download or usage of the provided files.

#### LEDiL Oy

Joensuunkatu 13  
FI-24240 SALO  
Finland

#### LEDiL Inc.

228 West Page Street  
Suite D  
Sycamore IL 60178  
USA

#### Ledil Optics Technology (Shenzhen) Co., Ltd.

# 405 , Block B  
Casic Motor Building  
Shenzhen 518057  
P.R.CHINA

#### Local sales and technical support

[www.ledil.com/  
where\\_to\\_buy](http://www.ledil.com/where_to_buy)

#### Shipping locations

Salo, Finland  
Hong Kong, China

#### Distribution Partners

[www.ledil.com/  
where\\_to\\_buy](http://www.ledil.com/where_to_buy)