

Relais Statique Triphasé

Three Phase Solid State Relay

SGT962360E

Sortie / **Output**: 3x25A/24-600Vac

Entrée / **Input**: 10-30Vdc

Entraxe 47,5mm /47.5mm mounting

- ❑ Relais statique synchrone Triphasé adapté aux charges résistives.
Three phase Zero-Cross Solid State Relay designed for resistive loads.
- ❑ Sorties thyristors hautes performances technologie TMS²(*) permettant une longue durée de vie et de forts courants de surcharge
New High Efficiency Back to back thyristors on output with TMS² technology() for a long lifetime expectancy and high surge currents*
- ❑ LED de visualisation sur l'entrée de couleur verte.
Green LED visualization on the input.
- ❑ Construit en conformité aux normes EN60947-4-3 (CEI60947-4-3), CEI62314 et UL-cUL
Designed in conformity with EN60947-4-3 (IEC60947-4-3), IEC62314 and UL-cUL

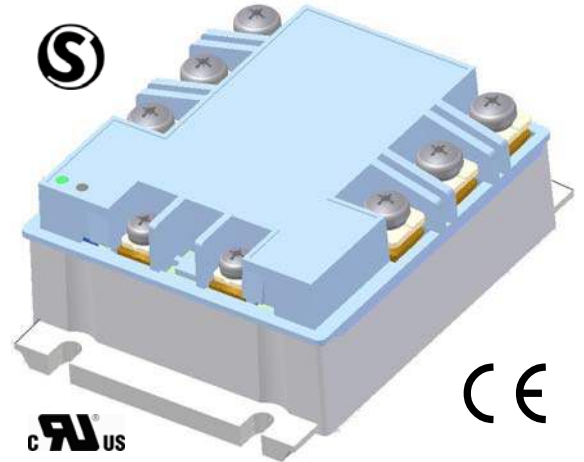

Application typique /
Typical application:

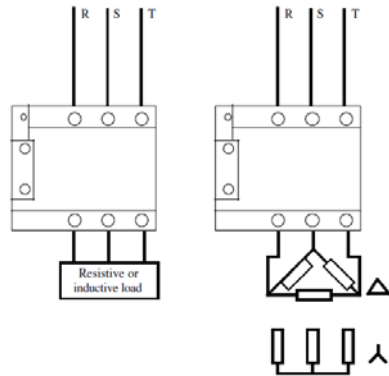

Circuit équivalent/Equivalent circuit :

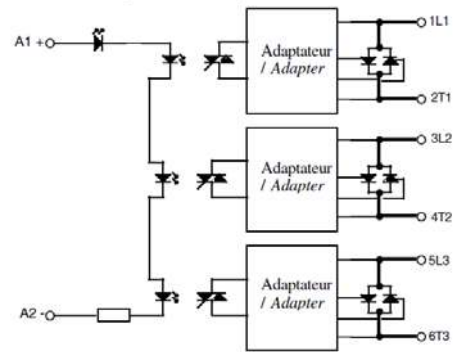

Caractéristiques de commande (à 20°C) / Control characteristics (at 20°C)

Paramètre / Parameter	Symbol	Min	Nom	Max	Unit
Tension de commande / Control voltage	Uc	10	24	30	Vdc
Courant de commande / Control current (@ Uc)	Ic	10	35	46	mAdc
Tension de relachement/Release voltage	Uc off	4			Vdc
Résistance interne / Input internal resistor (fig.1)	Rc		550		Ω
Tension inverse / Reverse voltage	Urv		30		Vdc

Caractéristiques générales / General characteristics

Isolement entrée-sortie/Input-output isolation @500m	Ui		4000		VRMS
Isolement sortie-semelle/Output-case isolation @500m	Ui		3300		VRMS
Tension assignée isolement/ Rated impulse voltage	Uimp		4000		V
Poids/Weight			370		g
Température de stockage / Storage temperature			-40 / +100		°C
Température de fonctionnement/Operating temperature			-40 / +100		°C
Résistance d'isolement / Insulation resistance @500Vdc	Ri		1000		MΩ
Humidité relative / Relative humidity	HR		40 to 85		%
Altitude maximale / Max. altitude			2000		m

fig. 1 :Caractéristique d'entrée / Control characteristic

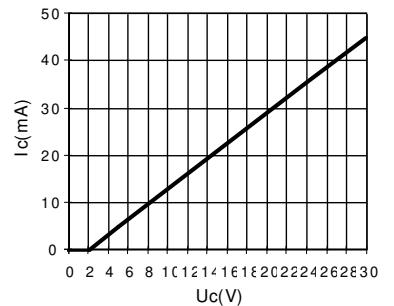

Proud to serve you

Caractéristiques sujettes à modifications sans préavis.
All technical characteristics are subject to change without previous notice.

Caractéristiques de sortie / Output characteristics (at 25°C)

Paramètre / Parameter	Conditions	Symbol	Min	Typ.	Max	Unit
Plage de tension utilisation / Operating voltage range		Ue	24	400	600	V rms
Tension de crête / Peak voltage		Up	1200			V
Niveau de synchronisme / Zero cross level		U _{sync}			35	V
Tension minimum amorçage / Latching voltage	Ie nom	Ua	10			V
Courant nominal / nominal current (AC-51)	AC-51 / LC-A	Ie		25		A rms
Courant surcharge / Non repetitive overload current	tp=10ms (Fig. 3)	I _{tsm}	320	420		A
Chute directe à l'état passant / On state voltage drop	@ 25°C	Vt			0,85	V
Résistance dynamique / On state dynamic resistance		rt			9,5	mΩ
Puissance dissipée (max) / Output power dissipation (max value)		Pd	$3x(0,9x0,85xI_e + 0,0095 x I_e^2)$			W
Résistance thermique jonction/semelle / Thermal resistance between junction to case		R _{thj/c}		0,5	0,7	K/W
Courant de fuite à l'état bloqué / Off state leakage current	@Ue typ, 50Hz	I _{lk}			1	mA
Courant minimum de charge / Minimum load current		I _{emin}	5			mA
Temps de fermeture / Turn on time	@Ue typ, 50Hz	t _{on max}			10	ms
Temps d'ouverture / Turn off time	@Ue typ, 50Hz	t _{off max}			10	ms
Fréquence utilisation / Operating frequency range	F mains	f	0,1	50-60	800	Hz
dv/dt à l'état bloqué / Off state dv/dt		dv/dt	500			V/μs
di/dt max / Maximum di/dt non repetitive		di/dt			50	A/μs
I ² t (Limite de fusion) / I ² t (Melting limit)	<10ms	I ² t	512	882		A ² s
Immunité conduite / Conducted immunity level	IEC/EN61000-4-4 (bursts)		2kV criterion B			
Immunité conduite / Conducted immunity level	IEC/EN61000-4-5 (surge)		2kV criterion A with external VDR			
Protection court-circuit / Short circuit protection	Type 2	Example	Fuse MERSEN gRC25A			

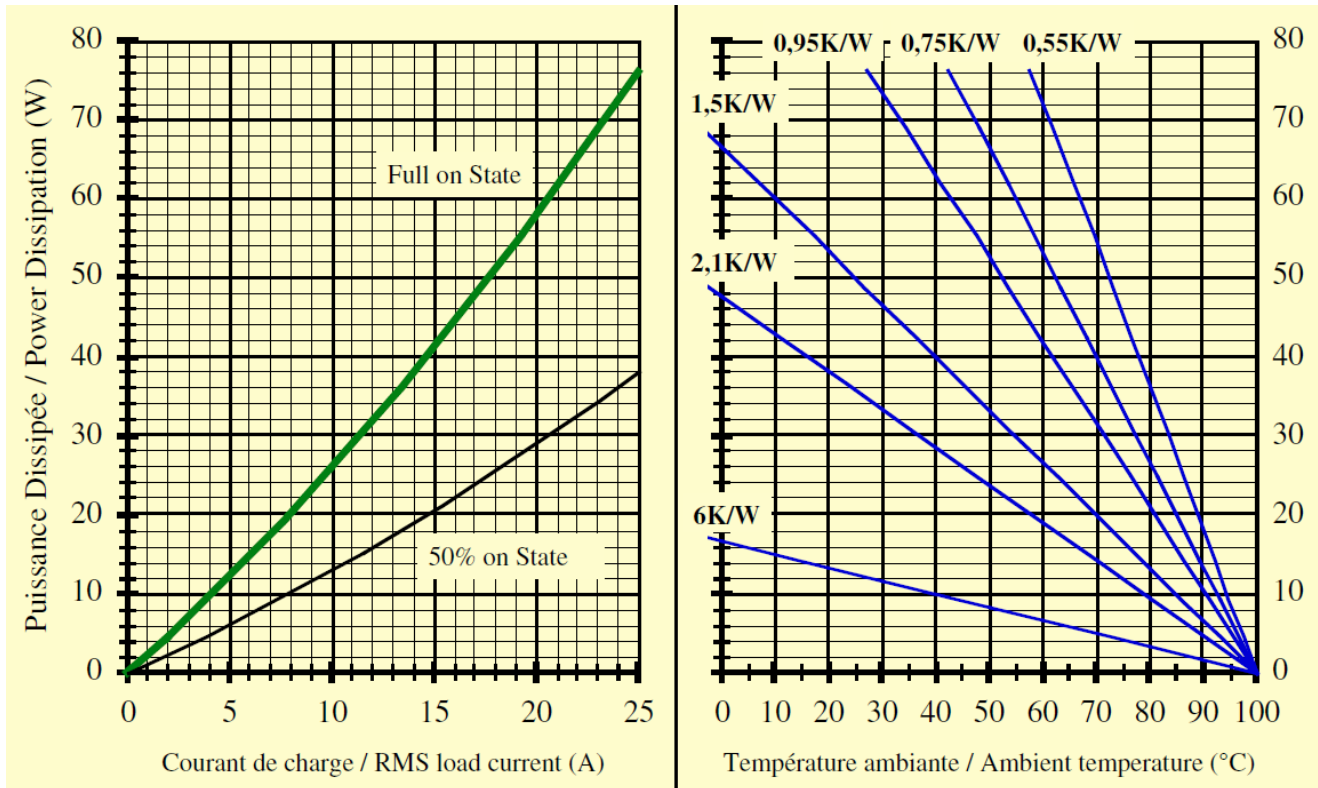
Caractéristiques thermiques / thermal curves :

celduc®
r e l a i s

www.celduc.com

5 Rue Ampère B.P. 30004 42290 SORBIERS - FRANCE E-Mail : celduc-relais@celduc.com
 Fax +33 (0) 4 77 53 85 51 Service Commercial France Tél. : +33 (0) 4 77 53 90 20
 Sales Dept. For Europe Tel. : +33 (0) 4 77 53 90 21 Sales Dept. Asia : Tél. +33 (0) 4 77 53 90 19

fig 3 : Courants de surcharges / *Overload currents*

1 - *Itsm non répétitif* sans tension réappliquée est donné pour la détermination des protections.

1 - *Non repetitive Itsm is given without voltage reapplied. This curve is used to define the protection (fuses).*

2 - *Itsm répétitif* est donné pour des surcharges de courant (T_j initiale=70°C).

Attention : la répétition de ces surcharges de courant diminue la durée de vie du relais.

2 - *Repetitive Itsm is given for inrush current with initial $T_j = 70^\circ\text{C}$. In normal operation, this curve mustn't be exceeded.*

Be careful, the repetition of the surge current decreases the life expectancy of the SSR.

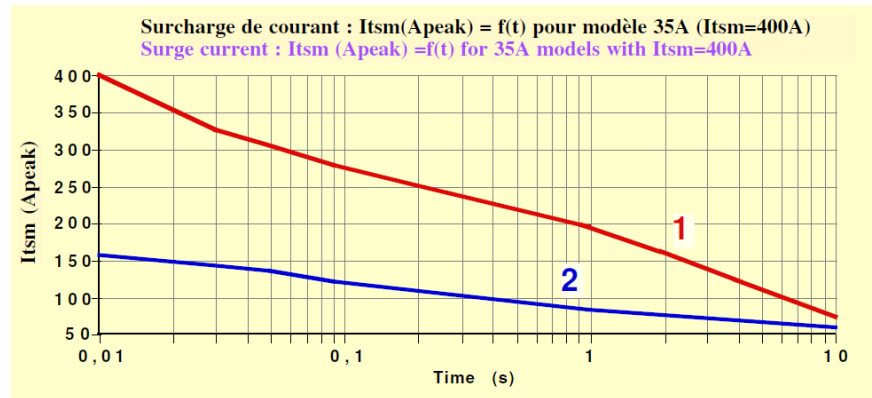

-> **Attention !** les relais à semi-conducteurs ne procurent pas d'isolation galvanique entre le réseau et la charge. Ils doivent être utilisés associés à un disjoncteur avec propriété de sectionnement ou similaire, afin d'assurer un sectionnement fiable en amont de la ligne dans l'hypothèse d'une défaillance et pour tous les cas où le relais doit être isolé du réseau (maintenance ; non utilisation sur une longue durée...).

-> **Warning !** *semiconductor relays don't provide any galvanic insulation between the load and the mains. Always use in conjunction with an adapted circuit breaker with isolation feature or a similar device in order to ensure a reliable insulation in the event of wrong function and when the relay must be insulated from the mains (maintenance ; if not used for a long duration ...).*

Dimensions

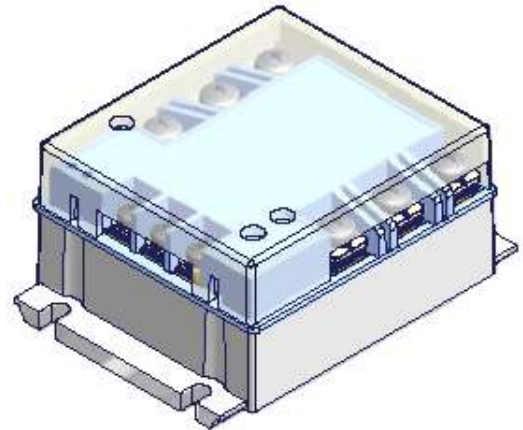
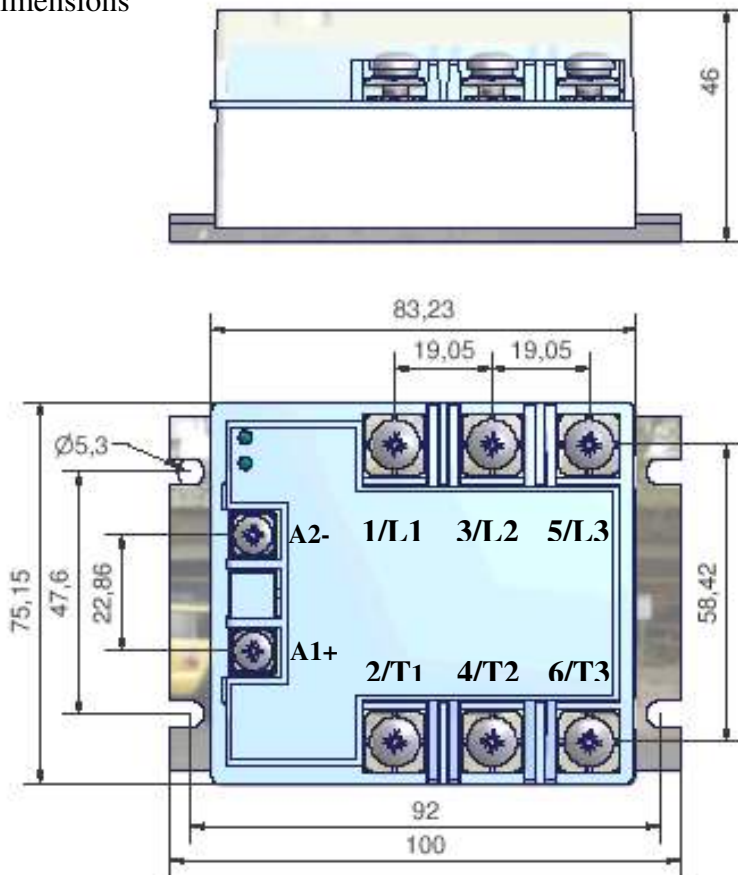

avec capot 1K199000

with transparent cover 1K199000

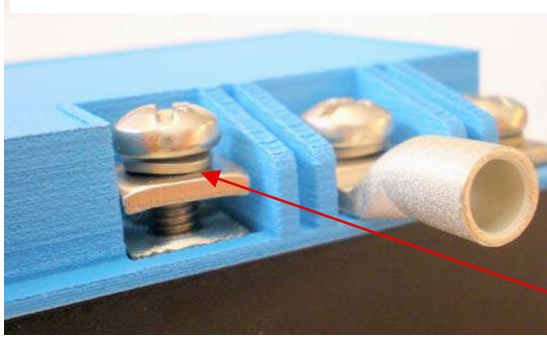







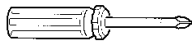
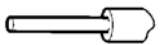

CONNEXIONS / TERMINALS

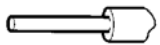
Connexions de puissance M5
M5 power connections

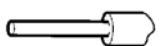

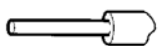
Connexions de commande M4
M4 control connections

Nouvelles bornes avec rondelles freins
New terminals with blocking washers

SGT						Raccordement d'entrée / Control wiring	
Nombre de fils / Number of wires				Modèle de tournevis / Screwdriver type	Couple de serrage recommandé <i>Recommended Torque</i>		
1		2					
Fil rigide (sans embout) <i>SOLID</i> (No ferrule)	Fil multibrins (avec embout) <i>FINE STRANDED</i> (With ferrule)	Fil rigide (sans embout) <i>SOLID</i> (No ferrule)	Fil multibrins (avec embout) <i>FINE STRANDED</i> (With ferrule)		M4		
							
0,75 ... 2,5 mm ² <i>AWG18...AWG14</i>	0,75 ... 2,5 mm ² <i>AWG18...AWG14</i>	0,75 ... 2,5 mm ² <i>AWG18...AWG14</i>	0,75 ... 2,5 mm ² <i>AWG18...AWG14</i>	POZIDRIV 2	1,2		
Raccordement de puissance / Power wiring							
Nombre de fils / Number of wires				Modèle de tournevis / Screwdriver type	Couple de serrage recommandé <i>Recommended Torque</i>		
1		2					
Fil rigide (sans embout) <i>SOLID</i> (No ferrule)	Fil multibrins (avec embout) <i>FINE STRANDED</i> (With ferrule)	Fil rigide (sans embout) <i>SOLID</i> (No ferrule)	Fil multibrins (avec embout) <i>FINE STRANDED</i> (With ferrule)		M5		
							
1,5 ... 10 mm ² <i>AWG16...AWG8</i>	1,5 ... 6 mm ² <i>AWG16...AWG10</i>	1,5 ... 10 mm ² <i>AWG16...AWG8</i>	1,5 ... 6 mm ² <i>AWG16...AWG10</i>	POZIDRIV 2	2		
Puissance avec cosses / Power with ring terminals.							
  				W max = 12,6mm 16 mm ² (<i>AWG6</i>) 25 mm ² (<i>AWG4</i>) 35mm ² (<i>AWG2 /AWG3</i>) 50mm ² (<i>AWG0 /AWG1</i>)			