

2232511-8 ✓ ACTIVE

[RAST | RAST 5 IDC Connectors](#)

TE Internal #: 2232511-8

PCB Mount Header, Vertical, Wire-to-Board, 8 Position, 5 mm [.197 in] Centerline, Fully Shrouded, Tin, Through Hole - Solder, RAST 5 IDC Connectors

[View on TE.com >](#)



Connectors > PCB Connectors > PCB Headers & Receptacles



Connector System: **Wire-to-Board**

Number of Positions: **8**

Number of Rows: **1**

Centerline (Pitch): **5 mm [.197 in]**

PCB Mount Orientation: **Vertical**

Features

Product Type Features

Connector System	Wire-to-Board
Header Type	Fully Shrouded
Sealable	No
Connector & Contact Terminates To	Printed Circuit Board
PCB Connector Assembly Type	PCB Mount Header

Configuration Features

Keying & Polarized Position Locations	2D, 3C, 6D, 7C
Number of Positions	8
Number of Rows	1
PCB Mount Orientation	Vertical

Electrical Characteristics

Operating Voltage	250 VAC
-------------------	---------

Body Features

Primary Product Color	Natural
-----------------------	---------



Contact Features

PCB Contact Termination Area Plating Material Thickness	3.8 μm [149.606 μin]
Contact Layout	Inline
Mating Tab Width	6.3 mm[.248 in]
Mating Tab Thickness	.8 mm[.032 in]
Contact Mating Area Plating Material Thickness	2 μm [.08 μin]
Contact Shape & Form	Square
Contact Mating Area Plating Material Finish	Matte
Contact Underplating Material	Nickel
PCB Contact Termination Area Plating Material	Tin
Contact Base Material	Copper Alloy
Contact Mating Area Plating Material	Tin
Contact Type	Tab
Contact Current Rating (Max)	16 A

Termination Features

Square Termination Post & Tail Dimension	.8 mm[.032 in]
Termination Post & Tail Length	3.5 mm[.138 in]
Termination Method to Printed Circuit Board	Through Hole - Solder

Mechanical Attachment

PCB Mount Alignment Type	Locating Posts
Mating Alignment Type	Keyed, Polarization
Mating Retention	With
Mating Retention Type	Latch
Connector Mounting Type	Board Mount
Mating Alignment	With
PCB Mount Alignment	With
PCB Mount Retention	Without

Housing Features

Housing Material	Nylon
Centerline (Pitch)	5 mm[.197 in]

Dimensions

Connector Length	27.3 mm[1.07 in]
------------------	------------------



Connector Height	12.8 mm[.5 in]
------------------	----------------

PCB Thickness (Recommended)	1.5 mm[.06 in]
-----------------------------	----------------

Row-to-Row Spacing	5 mm[.197 in]
--------------------	---------------

Usage Conditions

Operating Temperature Range	-40 – 120 °C[-40 – 248 °F]
-----------------------------	----------------------------

Operation/Application

Circuit Application	Power
---------------------	-------

Industry Standards

UL Flammability Rating	UL 94V-0
------------------------	----------

Packaging Features

Packaging Quantity	45
--------------------	----

Packaging Type	Loose Piece
----------------	-------------

Product Compliance

[For compliance documentation, visit the product page on TE.com>](#)

EU RoHS Directive 2011/65/EU	Compliant
------------------------------	-----------

EU ELV Directive 2000/53/EC	Compliant
-----------------------------	-----------

China RoHS 2 Directive MIIT Order No 32, 2016	No Restricted Materials Above Threshold
---	---

EU REACH Regulation (EC) No. 1907/2006	Current ECHA Candidate List: JUNE 2023 (235) Candidate List Declared Against: JAN 2023 (233) Does not contain REACH SVHC
--	--

Halogen Content	Not Low Halogen - contains Br or Cl > 900 ppm.
-----------------	--

Solder Process Capability	Not reviewed for solder process capability
---------------------------	--

Product Compliance Disclaimer

This information is provided based on reasonable inquiry of our suppliers and represents our current actual knowledge based on the information they provided. This information is subject to change. The part numbers that TE has identified as EU RoHS compliant have a maximum concentration of 0.1% by weight in homogenous materials for lead, hexavalent chromium, mercury, PBB, PBDE, DBP, BBP, DEHP, DIBP, and 0.01% for cadmium, or qualify for an exemption to these limits as defined in the Annexes of Directive 2011/65/EU (RoHS2). Finished electrical and electronic equipment products will be CE marked as required by Directive 2011/65/EU. Components may not be CE marked. Additionally, the part numbers that TE has identified as EU ELV compliant have a maximum concentration of 0.1% by weight in homogenous materials for lead, hexavalent chromium, and mercury, and 0.01% for cadmium, or qualify for an exemption to these limits as defined in the Annexes of Directive 2000/53/EC (ELV). Regarding the REACH Regulation, the information TE provides on SVHC in articles for this part number is based on the latest European Chemicals Agency (ECHA) 'Guidance on requirements for substances in articles' posted at this URL: <https://echa.europa.eu/guidance-documents/guidance-on-reach>

Compatible Parts

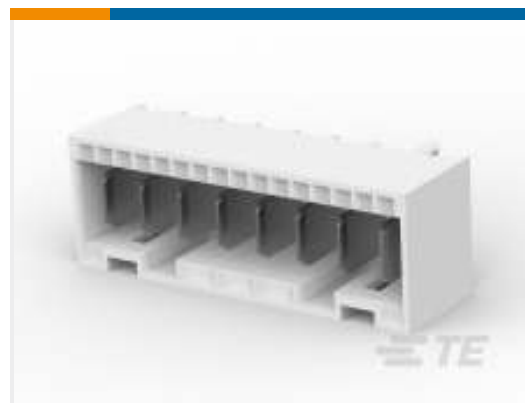

TE Part # 1971845-8
8P, RAST 5 Tab Header, THV



TE Part # 2232511-3
3P, RAST 5 TAB HEADER, THV

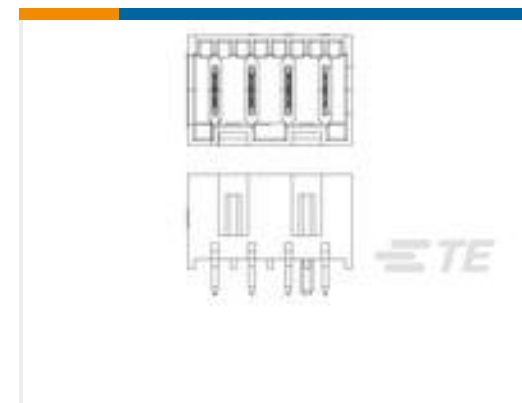

TE Part # 2232016-2
2P, RAST 5 Tab Header, THV



TE Part # 2232043-4
4P, RAST 5 Tab Header, THV

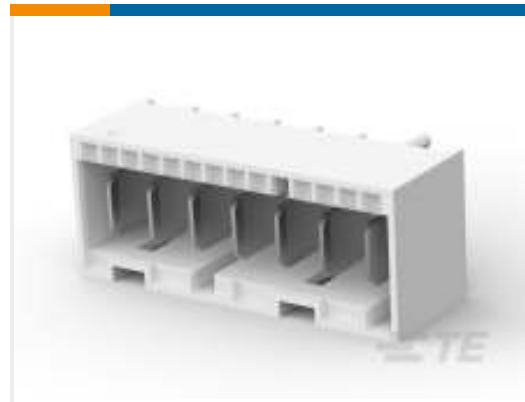

TE Part # 2232043-7
7P, RAST 5 Tab Header, THV



TE Part # 2232043-8
8P, RAST 5 Tab Header, THV



TE Part # 2232045-2
2P, RAST 5 Tab Header, THV

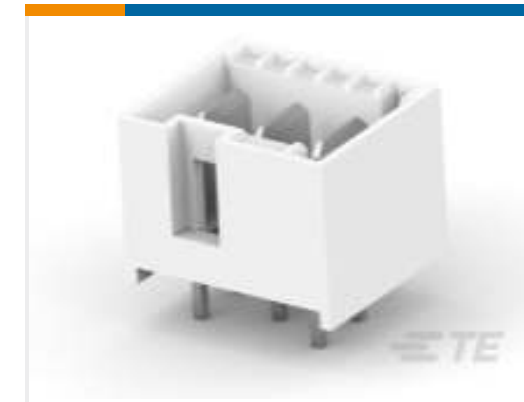

TE Part # 2232045-3
3P, RAST 5 Tab Header, THV



TE Part # 2232045-4
4P, RAST 5 Tab Header, THV



TE Part # 2232046-2
2P, RAST 5 Tab Header, THV



TE Part # 2232511-5
3P, RAST 5 TAB HEADER, THV

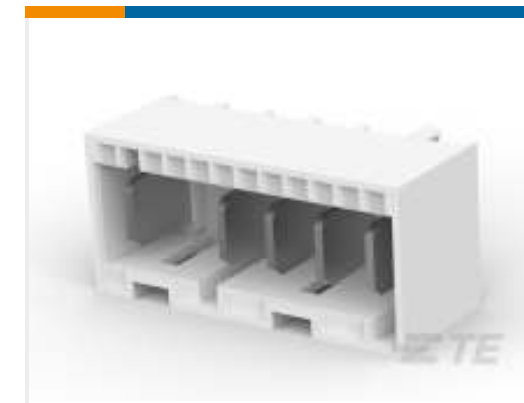

TE Part # 2232511-6
6P, RAST 5 Tab Header, THV



TE Part # 2232511-4
3P, RAST 5 TAB HEADER, THV

Also in the Series | RAST 5 IDC Connectors

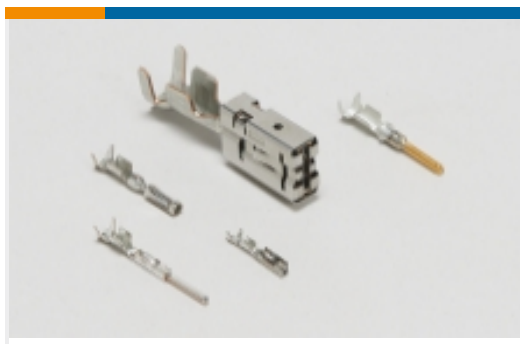

Automotive Terminals(8)



Connector Contacts(12)

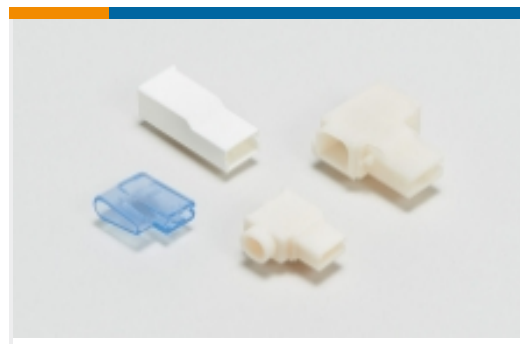

Crimp Terminal Housings(41)

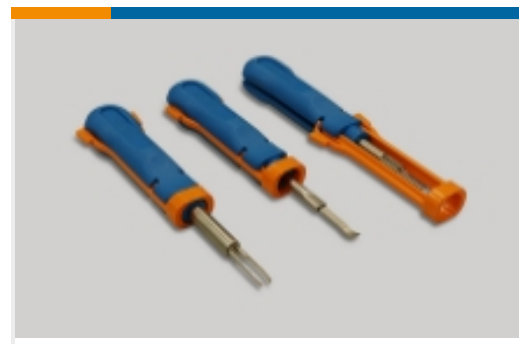

Insertion & Extraction Tools(1)



PCB Headers & Receptacles(417)



Rectangular Connector Housings(1)

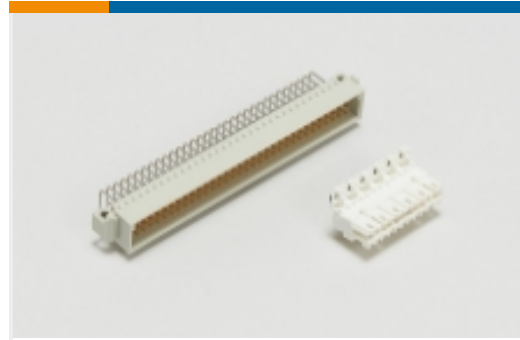

Standard Edge Connectors(34)



Standard Rectangular Connectors(68)



Wire-to-Board Connector Assemblies & Housings(214)



Wire-to-Board Connector Contacts(2)

Customers Also Bought



TE Part #2-342184-1
TAPE MOUNTED FEFG 12-10 R/T



TE Part #3-2176305-0
RP 1E 0.1W 215R 0.1% 25PPM 5K RL



TE Part #4-2176307-6
RP 1E 0.1W 36K5 0.1% 25PPM 5K RL



TE Part #7-2176306-9
RP 1E 0.1W 7K5 0.1% 25PPM 5K RL



TE Part #1-6609130-1
5EHM1=F8093



TE Part #4525-SS5A030GP
PRESS XDCR, ANALOG, PSI RANGE



TE Part #02351006-000
GA-HD GCD-SE-100 ASSY

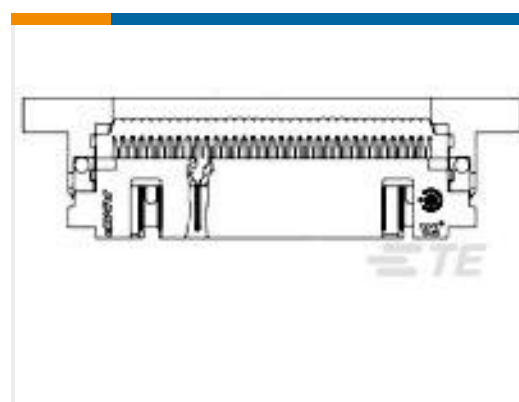

TE Part #5111448-5
024 UNIV I/O 30DP SLOT



Documents

Product Drawings

[8P, RAST 5 Tab Header, THV](#)

English

CAD Files

[3D PDF](#)

3D

Customer View Model

[ENG_CVM_CVM_2232511-8_C.2d_dxf.zip](#)

English

Customer View Model

[ENG_CVM_CVM_2232511-8_C.3d_igs.zip](#)

English

Customer View Model

[ENG_CVM_CVM_2232511-8_C.3d_stp.zip](#)

English

By downloading the CAD file I accept and agree to the [Terms and Conditions](#) of use.

Product Specifications

[Product Specification](#)

English

Agency Approvals

[UL Report](#)

English

[UL Report](#)

English