

PQ070XF01SZH

TO-220 Type, Low Voltage Operation
Low Power-Loss Voltage Regulators

■ Features

1. Low voltage operation
(Minimum operating voltage: 2.35V)
2. Low dissipation current
(Dissipation current at no load: MAX. 2mA)
3. Low power-loss
Dropout voltage: MAX.0.5V at $I_O=0.5A$
4. Built-in overcurrent and overheat protection functions
5. RoHS directive compliant

■ Applications

1. Power supplies for personal computers and peripheral equipment
2. Power supplies for various electronic equipment such as DVD player or STB
3. LBP

■ Absolute Maximum Ratings

($T_a=25^{\circ}C$)

Parameter	Symbol	Rating	Unit
*1 Input voltage	V_{IN}	10	V
*1 Output adjustment terminal voltage	V_{ADJ}	5	V
Output current	I_O	1.0	A
*2 Power dissipation	P_{D1}	1.4	W
	P_{D2}	15	
*3 Junction temperature	T_j	150	$^{\circ}C$
Operating temperature	T_{opr}	-40 to +85	$^{\circ}C$
Storage temperature	T_{stg}	-40 to +150	$^{\circ}C$
Soldering temperature	T_{sol}	260(10s)	$^{\circ}C$

*1 All are open except GND and applicable terminals.
 *2 P_{D1} : No heat sink, P_{D2} : With infinite heat sink.
 *3 Overheat protection may operate at $T_j=125^{\circ}C$ to $150^{\circ}C$

■ Outline Dimensions

(Unit : mm)

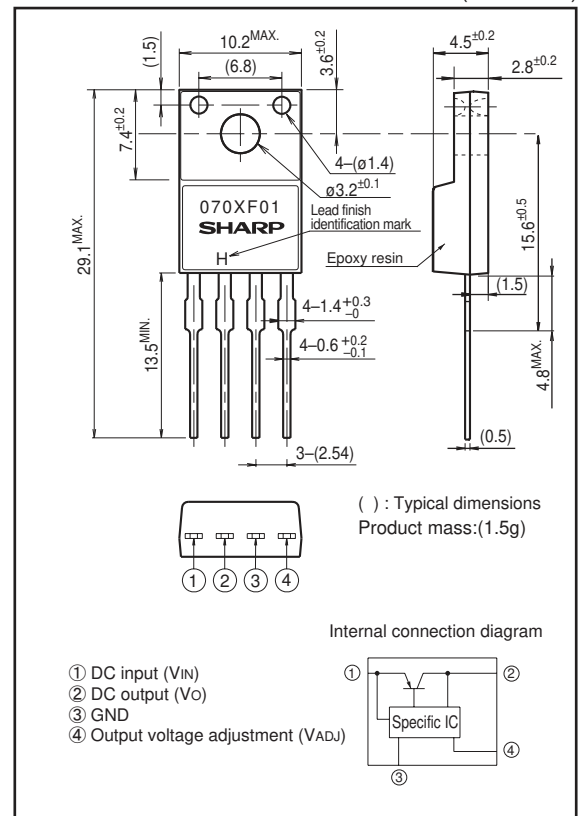

Lead finish: Lead-free solder plating
(Composition: Sn2Cu)

Electrical Characteristics

(Unless otherwise specified, condition shall be $V_{IN}=5V, V_O=3V(R_1=1k\Omega), I_O=0.5A, T_a=25^\circ C$)

Parameter	Symbol	Conditions	MIN.	TYP.	MAX.	Unit
Input voltage	V_{IN}	-	2.35	-	10	V
Output voltage	V_O	-	1.5	-	7	V
Reference voltage	V_{REF}	-	1.225	1.25	1.275	V
Load regulation	R_{egL}	$I_O=5mA$ to 1A	-	0.2	2.0	%
Line regulation	R_{egL}	$V_{IN}=4$ to 8V, $I_O=5mA$	-	0.2	1.0	%
Temperature coefficient of reference voltage	TcV_{REF}	$T_j=0$ to $+125^\circ C$, $I_O=5mA$	-	± 1.0	-	%
Ripple rejection	RR	Refer to Fig.2	45	60	-	dB
Dropout voltage	V_{I-O}	$V_{IN}=2.85V, I_O=0.5A$	-	-	0.5	V
Quiescent current	I_q	$I_O=0A$	-	1.3	2	mA

Fig.1 Test Circuit

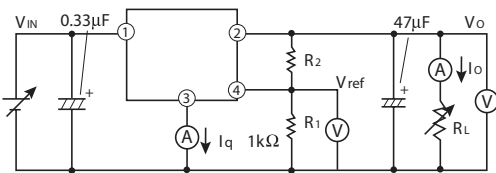

$$V_O = V_{ref} \times \left(1 + \frac{R_2}{R_1} \right)$$

[$R_1=1k\Omega, V_{ref}$ Nearly= $1.25V$]

Fig.2 Test Circuit of Ripple Rejection

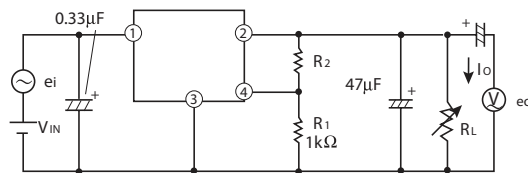

$f=120Hz$ (sine wave)
 $e_i(rms) = 0.5V$
 $I_O=0.5A$
 $RR=20 \log(e_i(rms) / e_o(rms))$
 $V_{IN}=5V$
 $V_O=3.0V(R_1=1k\Omega)$

Fig.3 Power Dissipation vs. Ambient Temperature

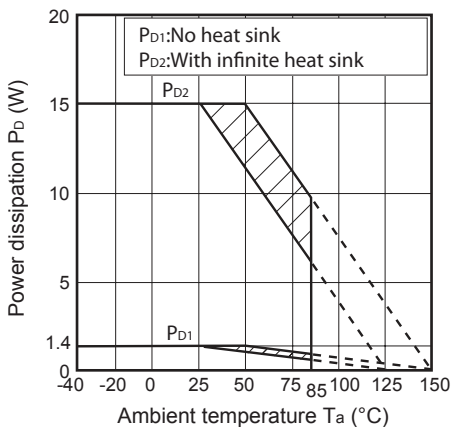

Note) Oblique line portion: Overheat protection may operate in this area.

Fig.4 Overcurrent Protection Characteristics (Typical Value)

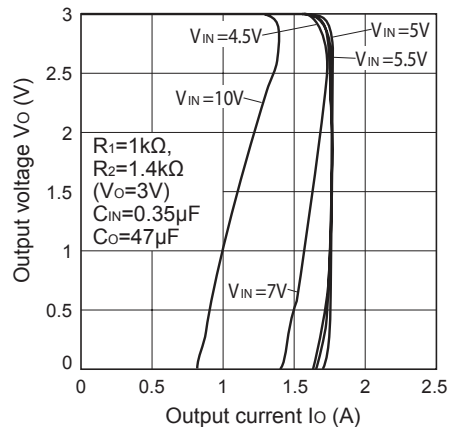

Fig.5 Reference Voltage vs. Junction Temperature

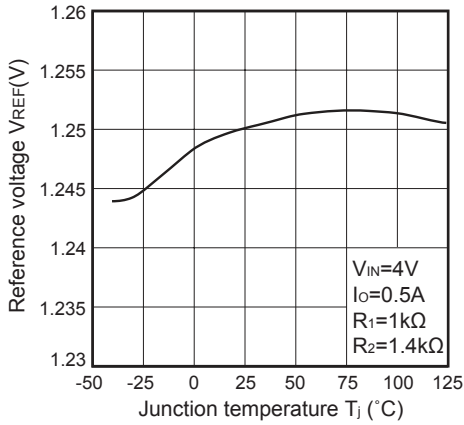

Fig.6 Output Voltage vs. Input Voltage

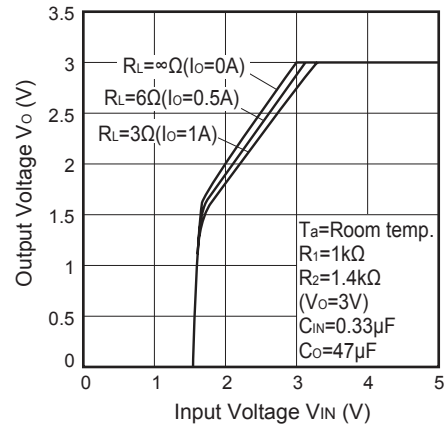

Fig.7 Circuit Operating Current vs. Input Voltage

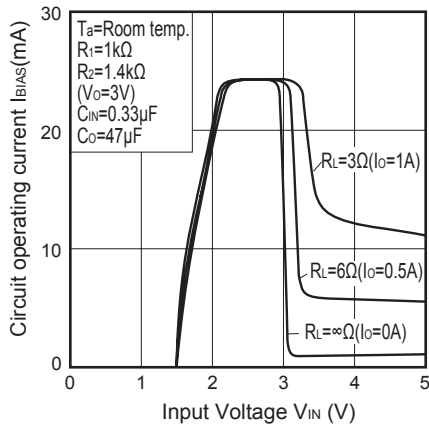

Fig.8 Dropout Voltage vs. Junction Temperature

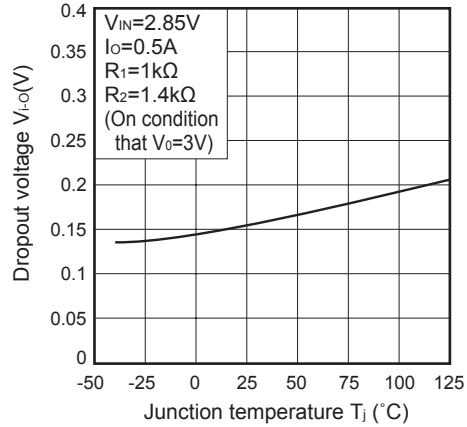

Fig.9 Quiescent Current vs. Junction Temperature

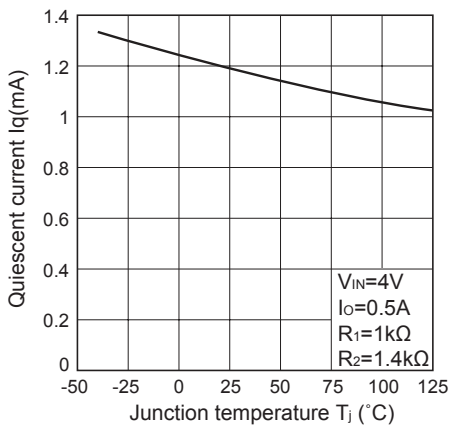

Fig.10 Ripple Rejection vs. Input Ripple Frequency

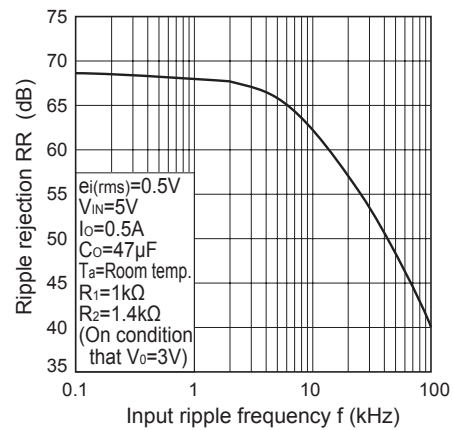

Fig.11 Ripple Rejection vs. Output Current

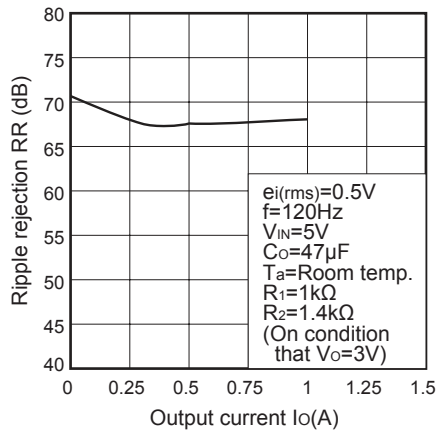
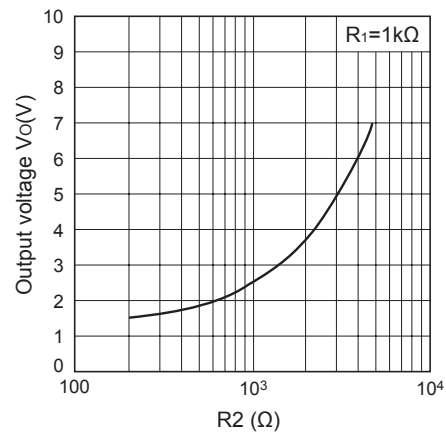
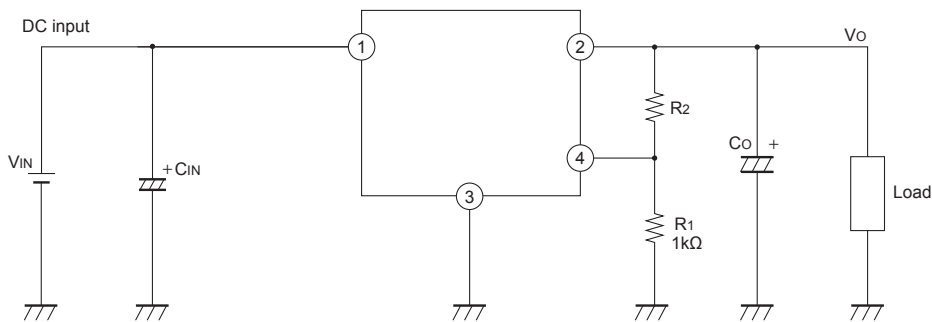

Fig.12 Output Voltage Adjustment Characteristics (Typical value)



■ Typical Application



■ Setting of Output Voltage

Output voltage is able to set from 1.5V to 7V when resistors R₁ and R₂ are attached to ②、③、④ terminals. As for the external resistors to set output voltage, refer to the figure below and Fig.12.

