

Trench gate field-stop 650 V, 30 A, soft-switching IH series IGBT in a TO-247 long leads package

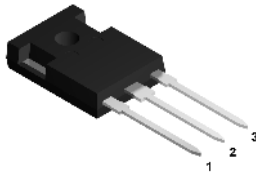

TO-247 long leads

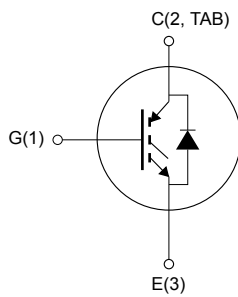

NG1E3C2T

Features

- Designed for soft commutation only
- Maximum junction temperature: $T_J = 175\text{ °C}$
- $V_{CE(sat)} = 1.55\text{ V (typ.) @ } I_C = 30\text{ A}$
- Minimized tail current
- Tight parameter distribution
- Low thermal resistance
- Low drop voltage freewheeling co-packaged diode
- Positive $V_{CE(sat)}$ temperature coefficient

Applications

- Induction heating
- Resonant converters
- Microwave ovens

Description

The newest IGBT 650 V soft-switching IH series has been developed using an advanced proprietary trench gate field-stop structure, whose performance is optimized both in conduction and switching losses for soft commutation. A freewheeling diode with a low drop forward voltage is included. The result is a product specifically designed to maximize efficiency for any resonant and soft-switching applications.



Product status link

[STGWA30IH65DF](#)

Product summary

Order code	STGWA30IH65DF
Marking	G30IH65DF
Package	TO-247 long leads
Packing	Tube

1 Electrical ratings

Table 1. Absolute maximum ratings

Symbol	Parameter	Value	Unit
V_{CES}	Collector-emitter voltage ($V_{GE} = 0$ V)	650	V
I_C	Continuous collector current at $T_C = 25$ °C	60	A
	Continuous collector current at $T_C = 100$ °C	30	
$I_{CP}^{(1)}$	Pulsed collector current	90	A
V_{GE}	Gate-emitter voltage	± 20	V
	Transient gate-emitter voltage ($t_p \leq 10$ μ s)	± 30	V
I_F	Continuous forward current at $T_C = 25$ °C	30	A
	Continuous forward current at $T_C = 100$ °C	15	
$I_{FP}^{(1)}$	Pulsed forward current	90	
P_{TOT}	Total power dissipation at $T_C = 25$ °C	180	W
T_{STG}	Storage temperature range	- 55 to 150	°C
T_J	Operating junction temperature range	- 55 to 175	

1. Pulse width limited by maximum junction temperature. Defined by design, not subjected to production test.

Table 2. Thermal data

Symbol	Parameter	Value	Unit
R_{thJC}	Thermal resistance junction-case IGBT	0.83	°C/W
	Thermal resistance junction-case diode	2.08	
R_{thJA}	Thermal resistance junction-ambient	50	

2 Electrical characteristics

$T_C = 25\text{ °C}$ unless otherwise specified

Table 3. Static characteristics

Symbol	Parameter	Test conditions	Min.	Typ.	Max.	Unit
$V_{(BR)CES}$	Collector-emitter breakdown voltage	$V_{GE} = 0\text{ V}$, $I_C = 250\text{ }\mu\text{A}$	650			V
$V_{CE(sat)}$	Collector-emitter saturation voltage	$V_{GE} = 15\text{ V}$, $I_C = 30\text{ A}$		1.55	2.05	V
		$V_{GE} = 15\text{ V}$, $I_C = 30\text{ A}$, $T_J = 125\text{ °C}$		1.75		
		$V_{GE} = 15\text{ V}$, $I_C = 30\text{ A}$, $T_J = 175\text{ °C}$		1.80		
V_F	Forward on-voltage	$I_F = 15\text{ A}$		1.65	2.35	V
		$I_F = 15\text{ A}$, $T_J = 125\text{ °C}$		1.50		
		$I_F = 15\text{ A}$, $T_J = 175\text{ °C}$		1.40		
		$I_F = 30\text{ A}$		2.00		
$V_{GE(th)}$	Gate threshold voltage	$V_{CE} = V_{GE}$, $I_C = 1\text{ mA}$	5	6	7	V
I_{CES}	Collector cut-off current	$V_{GE} = 0\text{ V}$, $V_{CE} = 650\text{ V}$			25	μA
I_{GES}	Gate-emitter leakage current	$V_{CE} = 0\text{ V}$, $V_{GE} = \pm 20\text{ V}$			± 250	nA

Table 4. Dynamic characteristics

Symbol	Parameter	Test conditions	Min.	Typ.	Max.	Unit
C_{ies}	Input capacitance	$V_{CE} = 25\text{ V}$, $f = 1\text{ MHz}$, $V_{GE} = 0\text{ V}$	-	1490	-	pF
C_{oes}	Output capacitance		-	82	-	
C_{res}	Reverse transfer capacitance		-	39	-	
Q_g	Total gate charge	$V_{CC} = 520\text{ V}$, $I_C = 30\text{ A}$, $V_{GE} = 0\text{ to }15\text{ V}$ (see Figure 23. Gate charge test circuit)	-	80	-	nC
Q_{ge}	Gate-emitter charge		-	11	-	
Q_{gc}	Gate-collector charge		-	39	-	

Table 5. IGBT switching characteristics (inductive load)

Symbol	Parameter	Test conditions	Min.	Typ.	Max.	Unit
$t_{d(off)}$	Turn-off delay time	$V_{CC} = 400\text{ V}$, $I_C = 30\text{ A}$,	-	200	-	ns
t_f	Current fall time	$V_{GE} = 15\text{ V}$, $R_G = 22\text{ }\Omega$ (see Figure 21. Test circuit for inductive load switching)	-	33	-	
$t_{d(off)}$	Turn-off delay time	$V_{CC} = 400\text{ V}$, $I_C = 30\text{ A}$,	-	224	-	ns
t_f	Current fall time	$V_{GE} = 15\text{ V}$, $R_G = 22\text{ }\Omega$, $T_J = 175\text{ °C}$ (see Figure 21. Test circuit for inductive load switching)	-	88	-	ns

Table 6. IGBT switching characteristics (capacitive load)

Symbol	Parameter	Test conditions	Min.	Typ.	Max.	Unit
$E_{off}^{(1)}$	Turn-off switching energy	$V_{CC} = 320\text{ V}$, $R_G = 10\ \Omega$, $I_C = 30\text{ A}$, $L = 100\ \mu\text{H}$, $C_{snub} = 22\text{ nF}$ (see Figure 22. Test circuit for snubbed inductive load switching)	-	123	-	μJ
		$V_{CC} = 320\text{ V}$, $R_G = 10\ \Omega$, $I_C = 30\text{ A}$, $L = 100\ \mu\text{H}$, $C_{snub} = 22\text{ nF}$, $T_J = 175\text{ }^\circ\text{C}$ (see Figure 22. Test circuit for snubbed inductive load switching)	-	298	-	

1. Including the tail of the collector current.

2.1 Electrical characteristics (curves)

Figure 1. Power dissipation vs case temperature

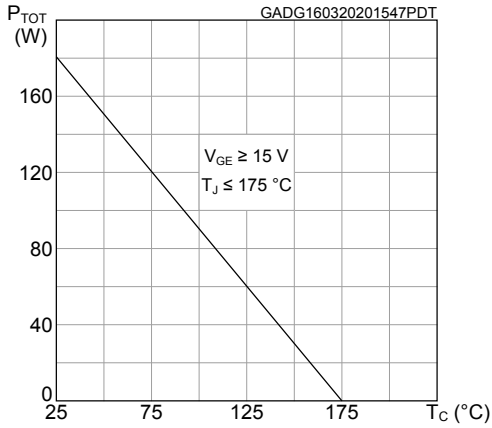

Figure 2. Collector current vs case temperature

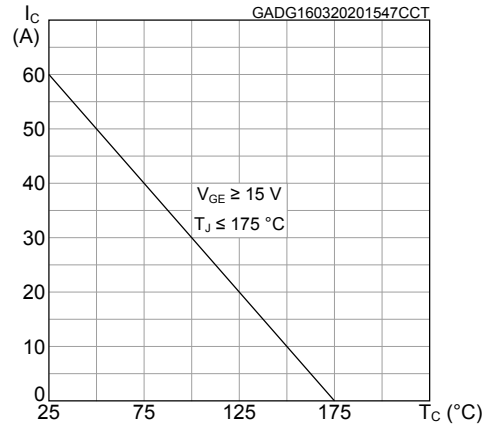

Figure 3. Output characteristics (T_J = 25 °C)

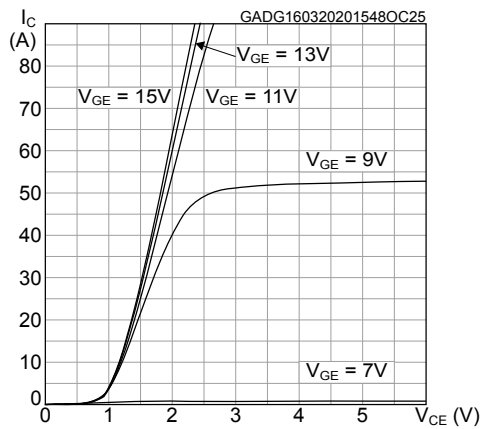

Figure 4. Output characteristics (T_J = 175 °C)

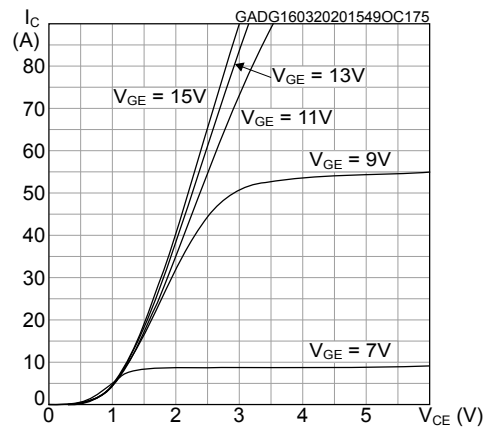

Figure 5. V_{CE(sat)} vs junction temperature

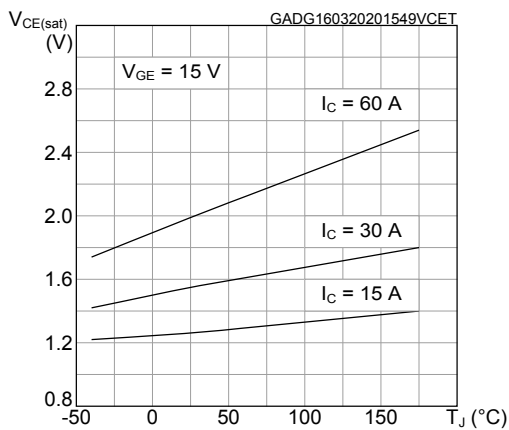

Figure 6. V_{CE(sat)} vs collector current

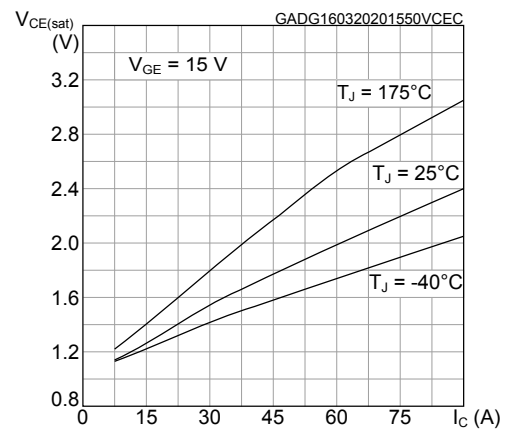

Figure 7. Forward bias safe operating area

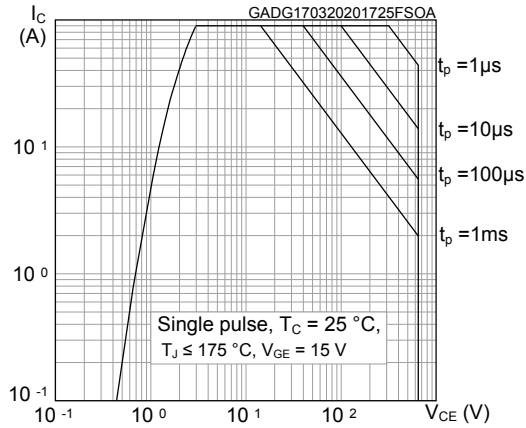

Figure 8. Transfer characteristics

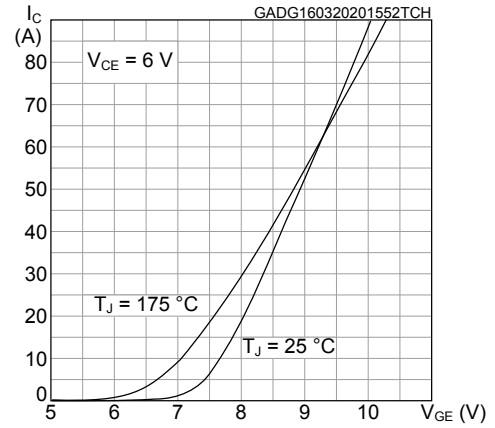

Figure 9. Diode V_F vs forward current

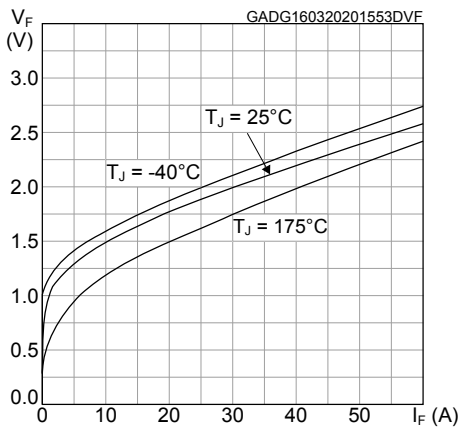

Figure 10. Normalized V_GE(th) vs junction temperature

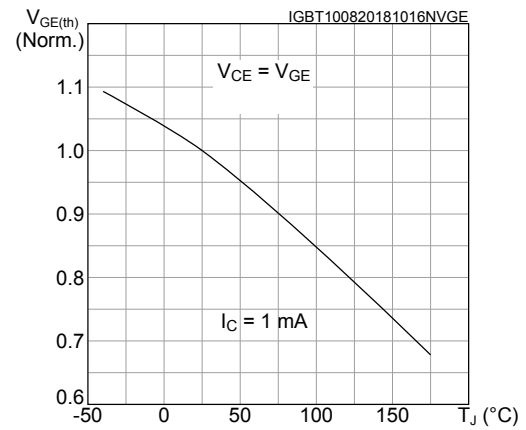

Figure 11. Normalized V_(BR)CES vs junction temperature

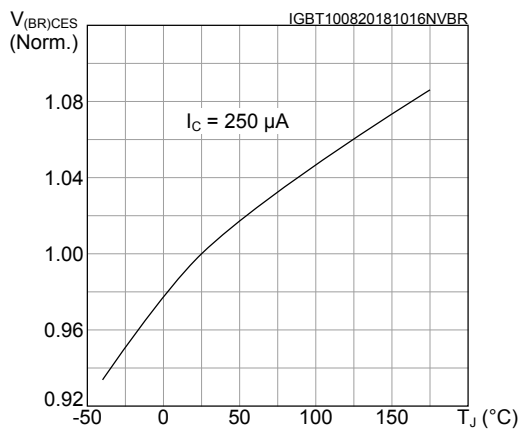

Figure 12. Capacitance variations

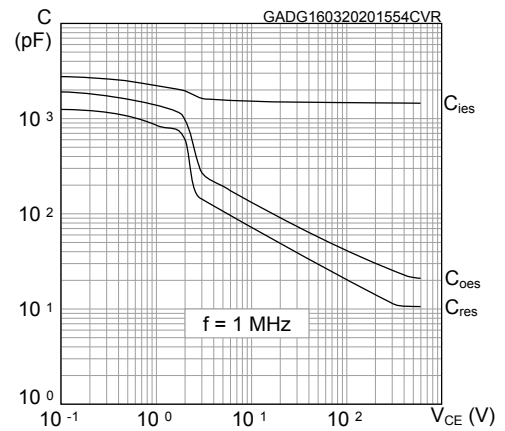

Figure 13. Gate charge vs gate-emitter voltage

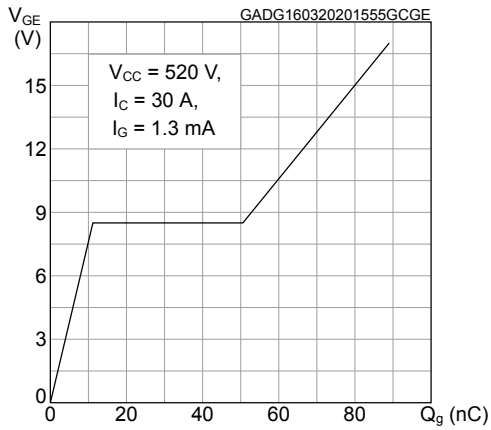

Figure 14. Switching energy vs collector current

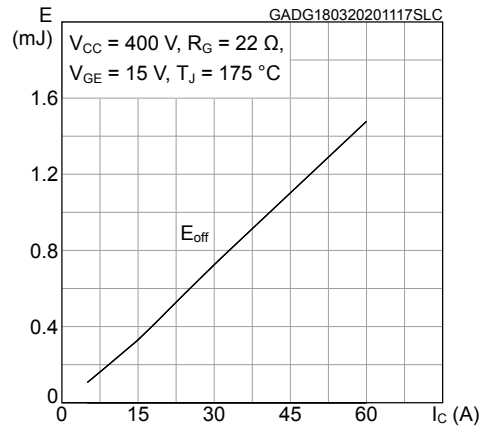

Figure 15. Switching energy vs temperature

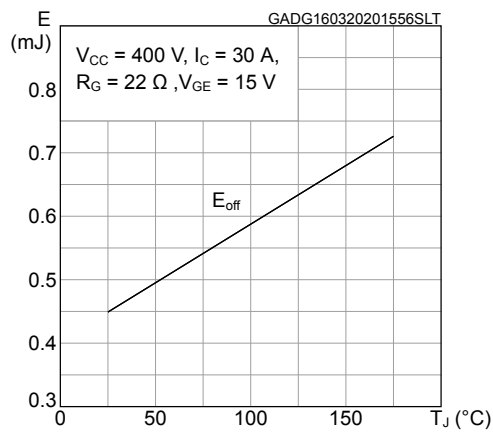

Figure 16. Switching energy vs collector emitter voltage

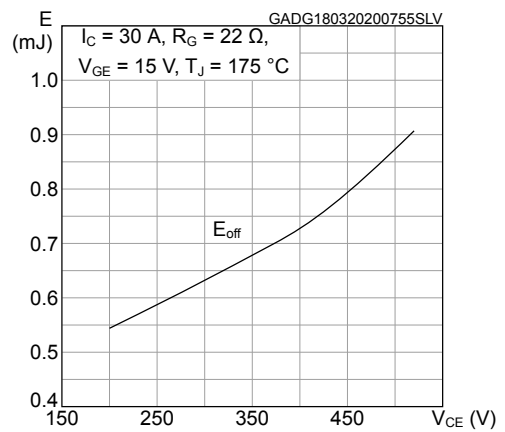

Figure 17. Switching times vs collector current

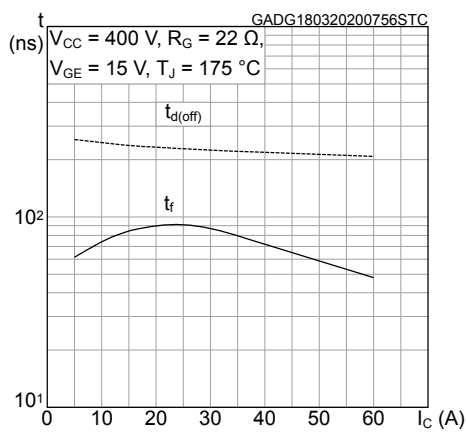

Figure 18. Switching energy vs snubber capacitance

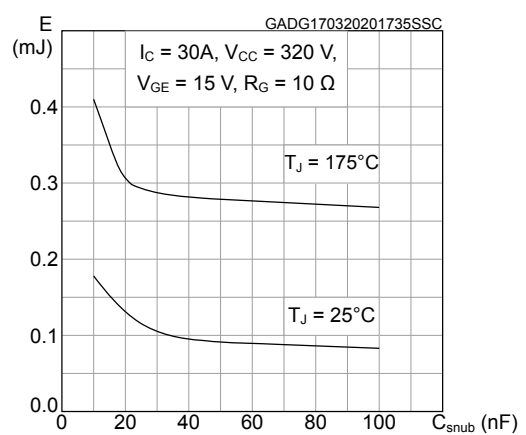

Figure 19. Thermal impedance for IGBT

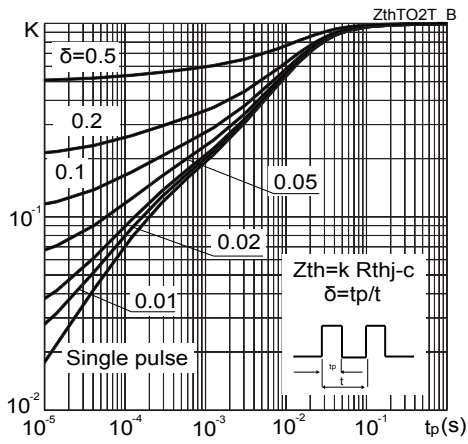
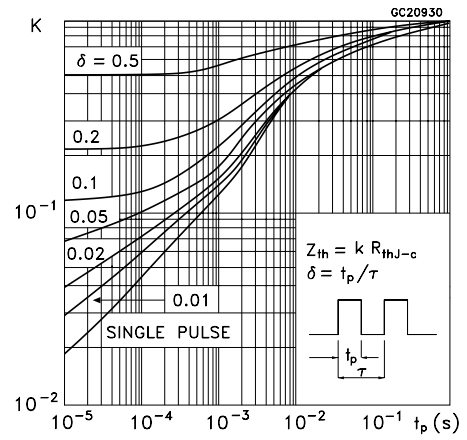

Figure 20. Thermal impedance for diode



3 Test circuits

Figure 21. Test circuit for inductive load switching

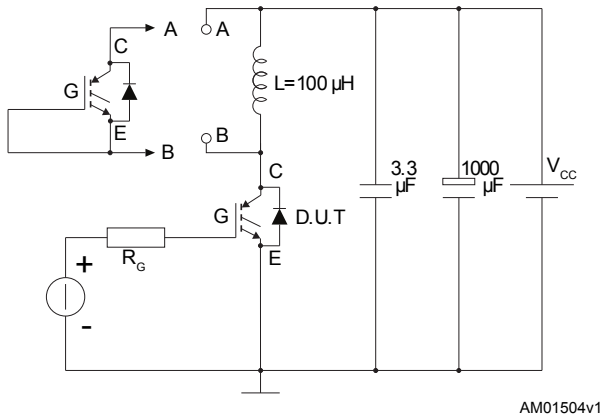

Figure 22. Test circuit for snubbed inductive load switching

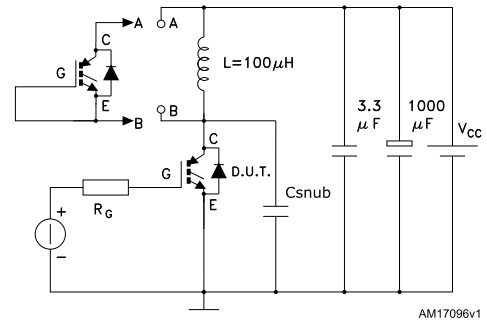

Figure 23. Gate charge test circuit

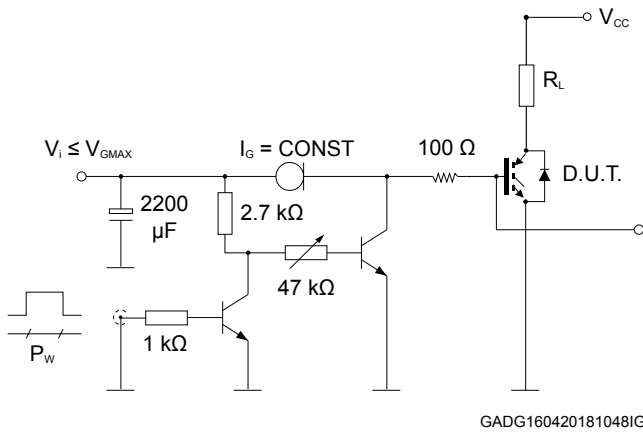
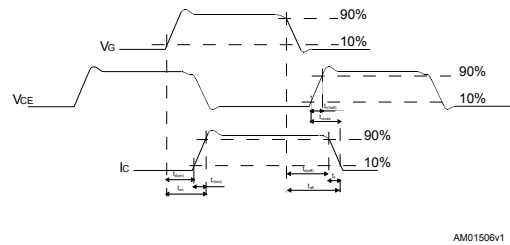

Figure 24. Switching waveform



4 Package information

In order to meet environmental requirements, ST offers these devices in different grades of **ECOPACK** packages, depending on their level of environmental compliance. ECOPACK specifications, grade definitions and product status are available at: www.st.com. ECOPACK is an ST trademark.

4.1 TO-247 long leads package information

Figure 25. TO-247 long leads package outline

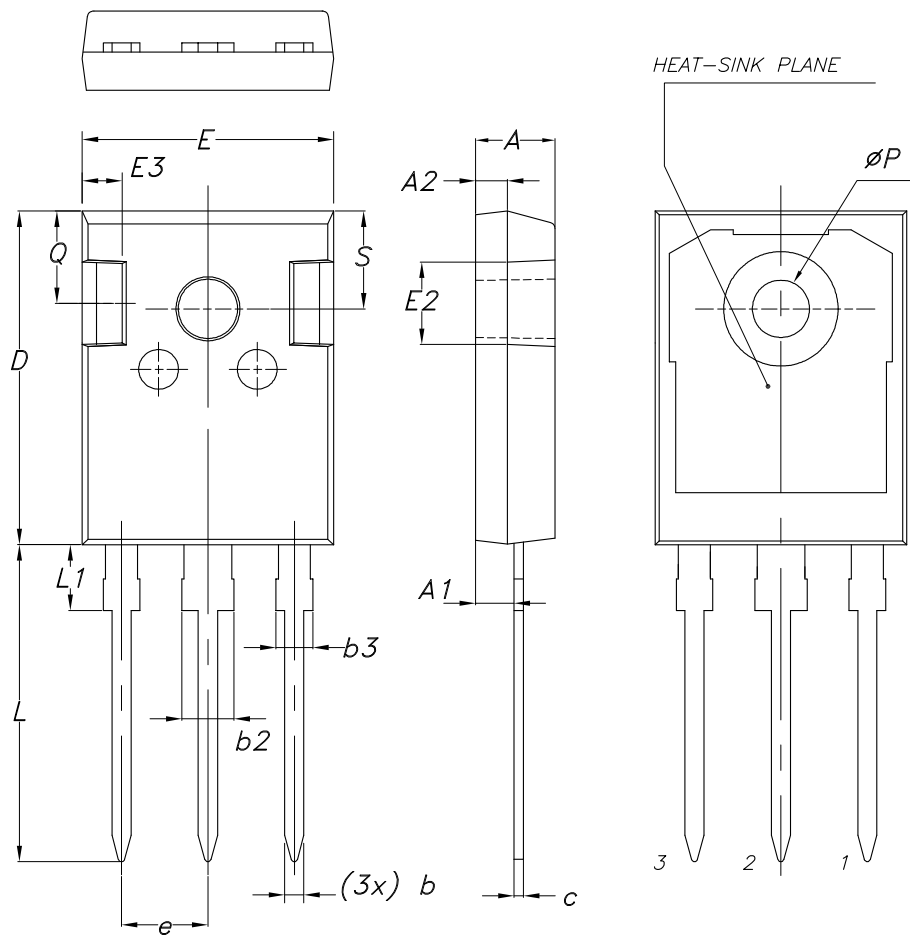

8463846_2_F

Table 7. TO-247 long leads package mechanical data

Dim.	mm		
	Min.	Typ.	Max.
A	4.90	5.00	5.10
A1	2.31	2.41	2.51
A2	1.90	2.00	2.10
b	1.16		1.26
b2			3.25
b3			2.25
c	0.59		0.66
D	20.90	21.00	21.10
E	15.70	15.80	15.90
E2	4.90	5.00	5.10
E3	2.40	2.50	2.60
e	5.34	5.44	5.54
L	19.80	19.92	20.10
L1			4.30
P	3.50	3.60	3.70
Q	5.60		6.00
S	6.05	6.15	6.25

Revision history

Table 8. Document revision history

Date	Revision	Changes
27-Mar-2020	1	First release.

Contents

1	Electrical ratings	2
2	Electrical characteristics	3
2.1	Electrical characteristics (curves)	5
3	Test circuits	9
4	Package information	10
4.1	TO-247 long leads package information	10
	Revision history	12

IMPORTANT NOTICE – PLEASE READ CAREFULLY

STMicroelectronics NV and its subsidiaries (“ST”) reserve the right to make changes, corrections, enhancements, modifications, and improvements to ST products and/or to this document at any time without notice. Purchasers should obtain the latest relevant information on ST products before placing orders. ST products are sold pursuant to ST’s terms and conditions of sale in place at the time of order acknowledgement.

Purchasers are solely responsible for the choice, selection, and use of ST products and ST assumes no liability for application assistance or the design of Purchasers’ products.

No license, express or implied, to any intellectual property right is granted by ST herein.

Resale of ST products with provisions different from the information set forth herein shall void any warranty granted by ST for such product.

ST and the ST logo are trademarks of ST. For additional information about ST trademarks, please refer to www.st.com/trademarks. All other product or service names are the property of their respective owners.

Information in this document supersedes and replaces information previously supplied in any prior versions of this document.

© 2020 STMicroelectronics – All rights reserved