



MATE-N-LOK | Universal MATE-N-LOK

TE Internal #: 926682-3

Rectangular Power Connectors, Housing, Receptacle, Wire-to-Panel / Wire-to-Wire, 6 Position, 6.35 mm [.25 in] Centerline, Universal MATE-N-LOK

[View on TE.com >](#)

Connectors > Power Connectors > Rectangular Power > Rectangular Power Connectors

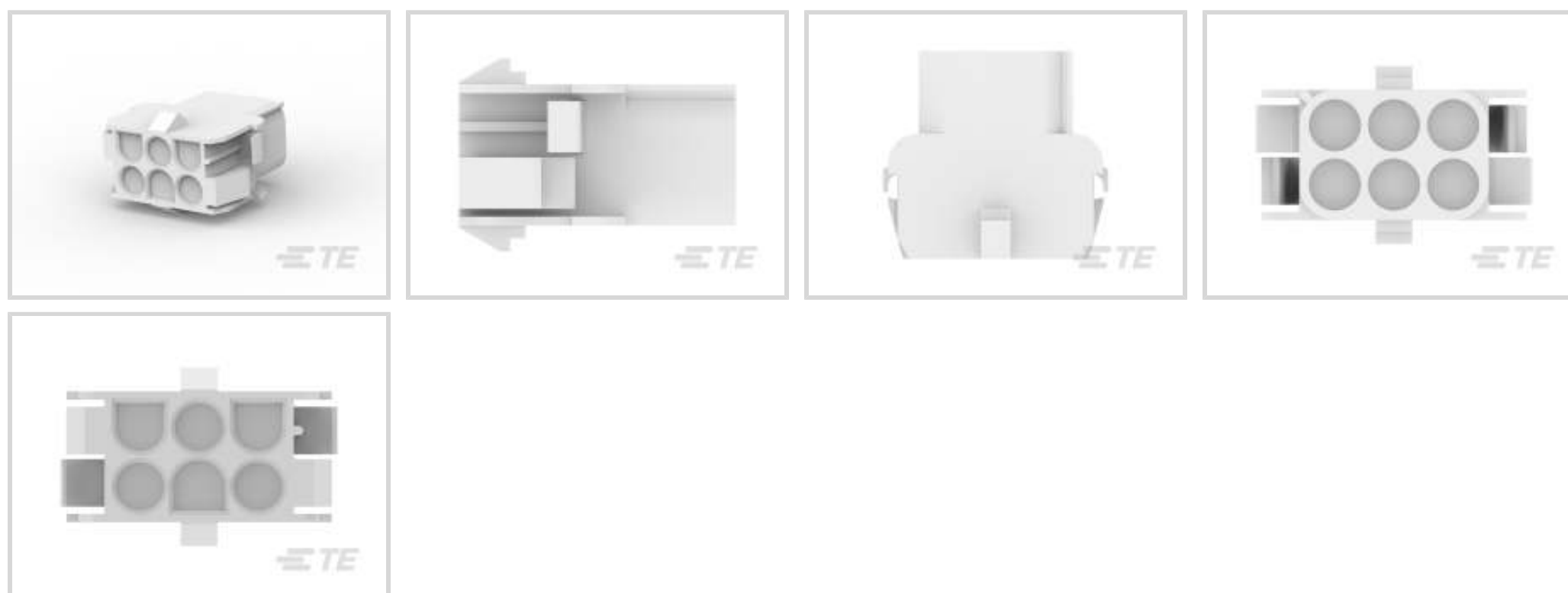

Rectangular Power Connector Type: **Housing**

Connector & Housing Type: **Receptacle**

Connector System: **Wire-to-Panel, Wire-to-Wire**

Number of Positions: **6**

Centerline (Pitch): **6.35 mm [.25 in]**

Features

Product Type Features

Rectangular Power Connector Type	Housing
Connector & Housing Type	Receptacle
Connector System	Wire-to-Panel, Wire-to-Wire
Sealable	No
Connector & Contact Terminates To	Wire & Cable

Configuration Features

Number of Positions	6
Number of Power Positions	0
Number of Signal Positions	0
Number of Rows	2

Electrical Characteristics

Operating Voltage	600 VAC
-------------------	---------

Contact Features

Multiple Contact Types	Without
------------------------	---------



Contact Layout	Matrix
Contact Retention Within Housing	Without
Contact Type	Pin

Termination Features

Termination Method to Wire & Cable	Crimp
------------------------------------	-------

Mechanical Attachment

Panel Mount Feature	With
Panel Mount Feature Type	Patch & Tabs
Connector Mounting Type	Panel Mount

Housing Features

Centerline (Pitch)	6.35 mm [.25 in]
Housing Color	Natural
Housing Material	PA 6.6

Dimensions

Panel Thickness (Recommended)	.76 – 2.29 mm [.03 – .09 in]
Row-to-Row Spacing	6.35 mm [.25 in]

Usage Conditions

Operating Temperature Range	-55 – 125 °C [-67 – 257 °F]
-----------------------------	-----------------------------

Operation/Application

Circuit Application	Power & Signal
---------------------	----------------

Industry Standards

CSA Rating	Certified, LR 7189
UL Rating	Recognized
Agency/Standard	CSA, UL, VDE
Approved Standards	UL E28476
UL Flammability Rating	UL 94V-0
Glow Wire Rating	Standard Part - Not Glow Wire

Packaging Features

Packaging Quantity	500
Packaging Method	Bag



Product Compliance

[For compliance documentation, visit the product page on TE.com>](#)

EU RoHS Directive 2011/65/EU	Compliant
EU ELV Directive 2000/53/EC	Compliant
China RoHS 2 Directive MIIT Order No 32, 2016	No Restricted Materials Above Threshold
EU REACH Regulation (EC) No. 1907/2006	Current ECHA Candidate List: JUNE 2023 (235) Candidate List Declared Against: JAN 2023 (233) Does not contain REACH SVHC
Halogen Content	Low Halogen - Br, Cl, F, I < 900 ppm per homogenous material. Also BFR/CFR/PVC Free
Solder Process Capability	Not applicable for solder process capability

Product Compliance Disclaimer

This information is provided based on reasonable inquiry of our suppliers and represents our current actual knowledge based on the information they provided. This information is subject to change. The part numbers that TE has identified as EU RoHS compliant have a maximum concentration of 0.1% by weight in homogenous materials for lead, hexavalent chromium, mercury, PBB, PBDE, DBP, BBP, DEHP, DIBP, and 0.01% for cadmium, or qualify for an exemption to these limits as defined in the Annexes of Directive 2011/65/EU (RoHS2). Finished electrical and electronic equipment products will be CE marked as required by Directive 2011/65/EU. Components may not be CE marked. Additionally, the part numbers that TE has identified as EU ELV compliant have a maximum concentration of 0.1% by weight in homogenous materials for lead, hexavalent chromium, and mercury, and 0.01% for cadmium, or qualify for an exemption to these limits as defined in the Annexes of Directive 2000/53/EC (ELV). Regarding the REACH Regulation, the information TE provides on SVHC in articles for this part number is based on the latest European Chemicals Agency (ECHA) 'Guidance on requirements for substances in articles' posted at this URL: <https://echa.europa.eu/guidance-documents/guidance-on-reach>

Compatible Parts

 <p>TE Part # 350431-4 06P UMNL PINHDR ASSY V2 NAT LF</p>	 <p>TE Part # 1-480705-2 06P UNML CAP HSG RED</p>	 <p>TE Part # 350732-4 06P UMNL PIN HDR ASSY 94VO LF</p>	 <p>TE Part # 350732-1 06P UMNL PIN HDR ASSY 94VO</p>
--	---	---	--



Also in the Series | **Universal MATE-N-LOK**

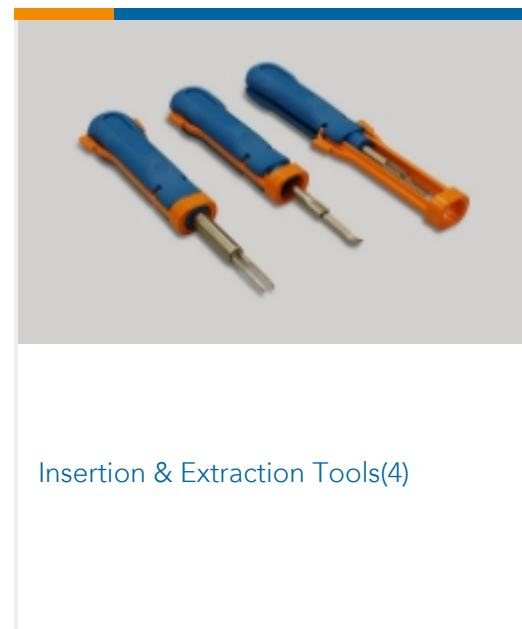
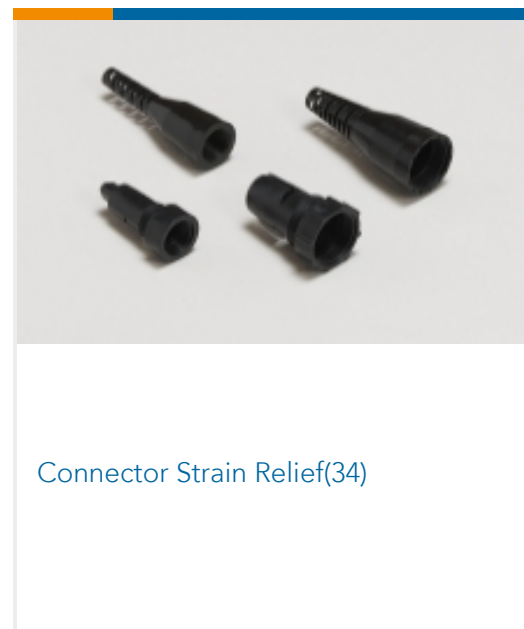
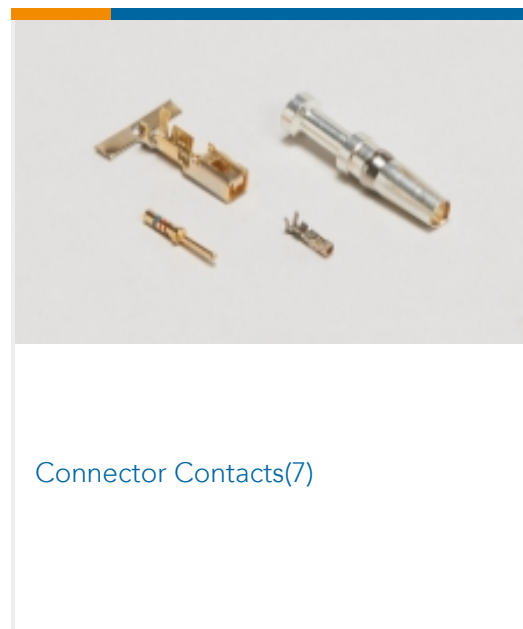
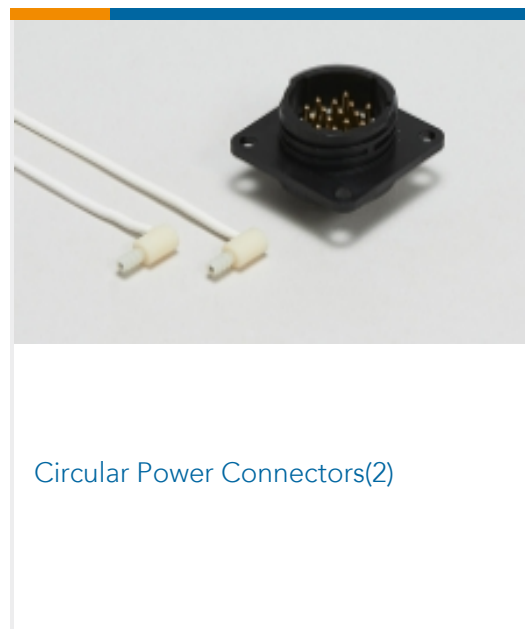

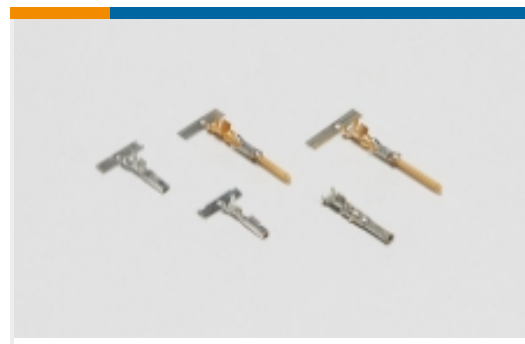

Power Contacts(201)

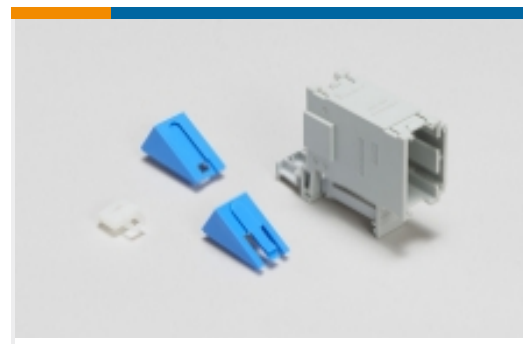

Rectangular Connector Adapters(7)

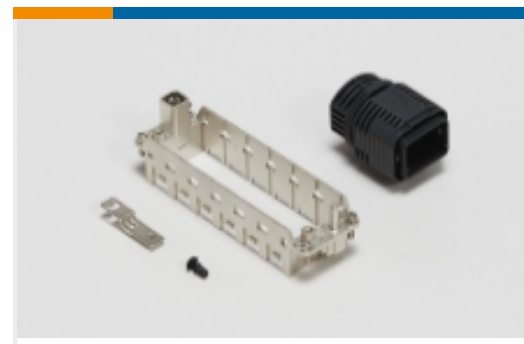

Rectangular Connector Hardware(1)



Rectangular Connector Housings(1)



Rectangular Connector Keying Plugs(3)

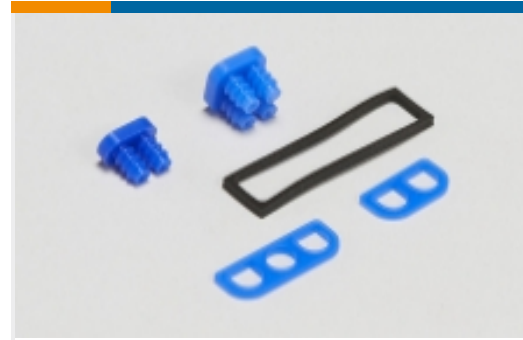

Rectangular Connector Seals(26)



Rectangular Power Connectors(662)

Customers Also Bought



TE Part #926647-3
UNIV.M-N-L.CAP HSG



TE Part #350735-4
12P UMNL PLUG HSG UL94V0



TE Part #350777-4
02P UMNL PLUG HSG UL94V0



TE Part #926305-6
UNML4WAY CAP

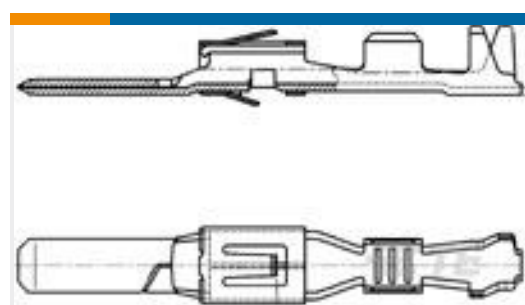

TE Part #962884-1
TAB AS 2.8x0.8 CONTACT CS SRC Sn



TE Part #926823-4
AM WIRE PIN 20-17 .013 PTPB



TE Part #1740149-6
MAG MATE LEAF TERMINAL MKII



TE Part #1-1414302-0
SAMPLES RESOLVER SIZE 21



TE Part #1-280001-3
250 FASTON,REC.,14-17 AWG,TPBR



TE Part #4-1393048-1
RESOLVER V23401-T2002-B209

Documents



Product Drawings

[06P UNIV.M-N-L.HSG.](#)

English

CAD Files

[3D PDF](#)

3D

Customer View Model

[ENG_CVM_CVM_926682-3_C.2d_dxf.zip](#)

English

Customer View Model

[ENG_CVM_CVM_926682-3_C.3d_igs.zip](#)

English

Customer View Model

[ENG_CVM_CVM_926682-3_C.3d_stp.zip](#)

English

By downloading the CAD file I accept and agree to the [Terms and Conditions](#) of use.

Product Specifications

[Application Specification](#)

German

Product Environmental Compliance

[MD_926682-3_1003201229](#)

English

[MD_926682-3_1003201229](#)

English

Agency Approvals

[VDE Certificate](#)

English