

MSCSM70VM19C3AG
Datasheet
Vienna Rectifier Phase Leg SiC Power
Module

April 2020



a  MICROCHIP company

Contents

1 Revision History.....	1
Revision 1.0.....	1
Product Overview.....	2
2.1 Features.....	3
2.2 Benefits.....	3
2.3 Applications.....	3
Electrical Specifications.....	4
3.1 SiC MOSFET Characteristics (per SiC MOSFET).....	4
3.2 SiC Schottky Diode Ratings Characteristics.....	6
3.3 Diode Characteristics.....	7
3.4 Thyristor Characteristics.....	7
3.5 Thermal and Package Characteristics.....	8
3.6 Typical SiC MOSFET Performance Curve.....	9
3.7 Typical SiC Diode Performance.....	11
3.8 Typical Diode Curves.....	12
Package Specification.....	13

Tables

Table 1 • Absolute Maximum Ratings.....	4
Table 2 • Electrical Characteristics.....	4
Table 3 • Dynamic Characteristics.....	5
Table 4 • Body Diode Ratings and Characteristics.....	5
Table 5 • Absolute Maximum Ratings.....	6
Table 6 • SiC Schottky Diode Ratings and Characteristics.....	6
Table 7 • Absolute Maximum Ratings.....	7
Table 8 • Electrical Characteristics.....	7
Table 9 • Absolute Maximum Ratings.....	7
Table 10 • Electrical Characteristics.....	8
Table 11 • Package Characteristics.....	8

Figures

Figure 1 • MSCSM70VM19C3AG Electrical Schematic.....	2
Figure 2 • MSCSM70VM19C3AG Pinout Location.....	2
Figure 3 • Maximum Thermal Impedance.....	9
Figure 4 • Output Characteristics at $T_J = 25\text{ }^\circ\text{C}$	9
Figure 5 • Output Characteristics at $T_J = 175\text{ }^\circ\text{C}$	9
Figure 6 • Normalized $R_{DS(on)}$ vs. Temperature.....	9
Figure 7 • Transfer Characteristics.....	9
Figure 8 • Capacitance vs. Drain Source Voltage.....	10
Figure 9 • Gate Charge vs. Gate Source Voltage.....	10
Figure 10 • Body Diode Char, $T_J = 25\text{ }^\circ\text{C}$	10
Figure 11 • 3rd Quadrant Char, $T_J = 25\text{ }^\circ\text{C}$	10
Figure 12 • Body Diode Char, $T_J = 175\text{ }^\circ\text{C}$	10
Figure 13 • 3rd Quadrant Char, $T_J = 175\text{ }^\circ\text{C}$	10
Figure 14 • Switching Energy vs. Current.....	11
Figure 15 • Turn-on Energy vs. R_g	11
Figure 16 • Operating Frequency vs. Drain Current.....	11
Figure 17 • Turn-off Energy vs. R_g	11
Figure 18 • Maximum Thermal Impedance.....	11
Figure 19 • Forward Characteristics.....	12
Figure 20 • Capacitance vs. Reverse Voltage.....	12
Figure 21 • Maximum Thermal Impedance.....	12
Figure 22 • Forward Characteristics.....	12
Figure 23 • Package Outline.....	13

1 Revision History

The revision history describes the changes that were implemented in the document. The changes are listed by revision, starting with the most current publication.

1.1 Revision 1.0

Revision 1.0 is the first publication of this document, published in April 2020.

2 Product Overview

The MSCSM70VM19C3AG is Vienna Rectifier phase leg 700 V/124 A full Silicon Carbide power module.

Figure 1 • MSCSM70VM19C3AG Electrical Schematic

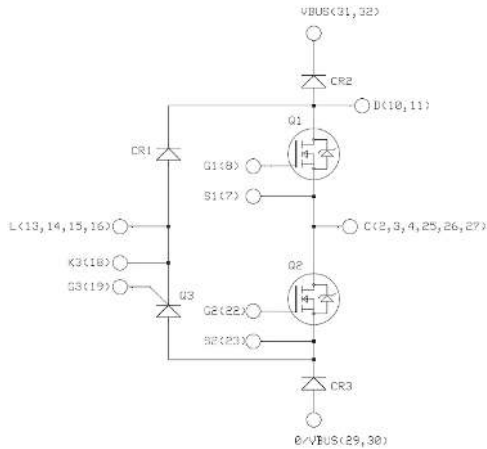
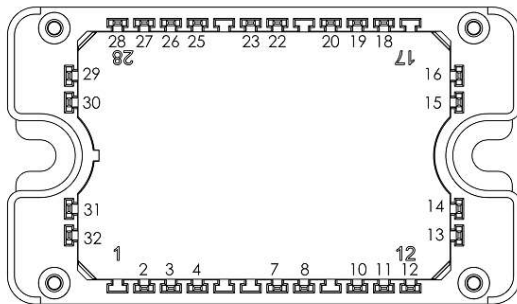

Figure 2 • MSCSM70VM19C3AG Pinout Location



All multiple inputs and outputs must be shorted together

All ratings at $T_j = 25\text{ }^\circ\text{C}$ unless otherwise specified.

Caution: These devices are sensitive to electrostatic discharge. Proper handling procedures should be followed.

2.1 Features

The following are key features of the MSCSM70VM19C3AG device:

- SiC Power MOSFET
 - Low RDS(on)
 - High temperature performance
- Silicon carbide (SiC) Schottky diode (CR2 and CR3)
 - Zero reverse recovery
 - Zero forward recovery
 - Temperature-independent switching behavior
 - Positive temperature coefficient on VF
- Kelvin emitter for easy drive
- Very low stray inductance
- High level of integration
- Aluminum nitride (AlN) substrate for improved thermal performance

2.2 Benefits

The following are benefits of the MSCSM70VM19C3AG device:

- Outstanding performance at high frequency operation
- Direct mounting to heatsink (isolated package)
- Low junction-to-case thermal resistance
- Solderable terminals both for power and signal for easy PCB mounting
- Low profile
- RoHS compliant

2.3 Applications

The MSCSM70VM19C3AG device is designed for the following applications:

- Plasma and induction heating
- Uninterruptible power supplies

3 Electrical Specifications

This section shows the electrical specifications of the MSCSM70VM19C3AG device.

3.1 SiC MOSFET Characteristics (per SiC MOSFET)

This section describes the electrical characteristics of the MSCSM70VM19C3AG (Q1 and Q2) device.

Table 1 • Absolute Maximum Ratings

Symbol	Parameter	Maximum Ratings	Unit
V_{DSS}	Drain-source voltage	700	V
I_D	Continuous drain current	$T_C = 25\text{ }^\circ\text{C}$ 124 ¹	A
		$T_C = 80\text{ }^\circ\text{C}$ 98 ¹	
I_{DM}	Pulsed drain current	250	
V_{GS}	Gate-source voltage	-10/25	V
R_{Dson}	Drain-source ON resistance	19	m Ω
P_D	Power dissipation	$T_C = 25\text{ }^\circ\text{C}$ 365	W

Note:

1. Specification of SiC MOSFET device but output current must be limited due to size of power connectors.

Table 2 • Electrical Characteristics

Symbol	Characteristic	Test Conditions	Min	Typ	Max	Unit
I_{DSS}	Zero gate voltage drain current	$V_{GS} = 0\text{ V}; V_{DS} = 700\text{ V}$			100	μA
R_{Dson}	Drain-source on resistance	$V_{GS} = 20\text{ V}$ $I_D = 40\text{ A}$	$T_J = 25\text{ }^\circ\text{C}$	15	19	m Ω
			$T_J = 175\text{ }^\circ\text{C}$		18.8	
$V_{GS(th)}$	Gate threshold voltage	$V_{GS} = V_{DS}, I_D = 4\text{ mA}$	1.9	2.4		V
I_{GSS}	Gate-source leakage current	$V_{GS} = 20\text{ V}, V_{DS} = 0\text{ V}$			150	nA

Table 3 • Dynamic Characteristics

Symbol	Characteristic	Test Conditions	Min	Typ	Max	Unit
C_{iss}	Input capacitance	$V_{GS} = 0\text{ V}$ $V_{DS} = 700\text{ V}$ $f = 1\text{ MHz}$		4500		pF
C_{oss}	Output capacitance			510		
C_{rss}	Reverse transfer capacitance			29		
Q_g	Total gate charge	$V_{GS} = -5/20\text{ V}$ $V_{Bus} = 470\text{ V}$ $I_D = 40\text{ A}$		215		nC
Q_{gs}	Gate-source charge			58		
Q_{gd}	Gate-drain charge			35		
$T_{d(on)}$	Turn-on delay time	$V_{GS} = -5/20\text{ V}$ $V_{Bus} = 400\text{ V}$ $I_D = 80\text{ A}$ $T_J = 150\text{ }^\circ\text{C}$ $R_{Gon} = 27\text{ }\Omega$; $R_{Goff} = 4.7\text{ }\Omega$		40		ns
T_r	Rise time			35		
$T_{d(off)}$	Turn-off delay time			50		
T_f	Fall time			20		
E_{on}	Turn on energy	$V_{GS} = -5/20\text{ V}$		$T_J = 150\text{ }^\circ\text{C}$	545	μJ
E_{off}	Turn off energy	$V_{Bus} = 400\text{ V}$ $I_D = 80\text{ A}$ $R_{Gon} = 27\text{ }\Omega$ $R_{Goff} = 4.7\text{ }\Omega$		$T_J = 150\text{ }^\circ\text{C}$	186	μJ
R_{Gint}	Internal gate resistance			0.69		Ω
R_{thJC}	Junction-to-case thermal resistance				0.41	$^\circ\text{C/W}$

Table 4 • Body Diode Ratings and Characteristics

Symbol	Characteristic	Test Conditions	Min	Typ	Max	Unit
V_{SD}	Diode forward voltage	$V_{GS} = 0\text{ V}$; $I_{SD} = 40\text{ A}$		3.4		V
		$V_{GS} = -5\text{ V}$; $I_{SD} = 40\text{ A}$		3.8		
t_{rr}	Reverse recovery time	$I_{SD} = 40\text{ A}$; $V_{GS} = -5\text{ V}$ $V_R = 400\text{ V}$; $di_F/dt = 1000\text{ A}/\mu\text{s}$		38		ns
Q_{rr}	Reverse recovery charge			318		nC
I_{rr}	Reverse recovery current				14.8	

3.2 SiC Schottky Diode Ratings Characteristics

This section shows the SiC Schottky diode (CR2 and CR3) ratings and characteristics of the device.

Table 5 • Absolute Maximum Ratings

Symbol	Parameter	Max Ratings	Unit
V_{RRM}	Peak repetitive reverse voltage	700	V
I_F	DC forward current	$T_C = 80\text{ }^\circ\text{C}$	50 A
P_D	Power dissipation	$T_C = 25\text{ }^\circ\text{C}$	174 W

Table 6 • SiC Schottky Diode Ratings and Characteristics

Symbol	Characteristic	Test Conditions	Min	Typ	Max	Unit
V_{RRM}	Peak repetitive reverse voltage				700	V
I_{RRM}	Reverse leakage current	$V_R = 700\text{ V}$	$T_J = 25\text{ }^\circ\text{C}$	15	200	μA
			$T_J = 175\text{ }^\circ\text{C}$	250		
V_F	Diode forward voltage	$I_F = 50\text{ A}$	$T_J = 25\text{ }^\circ\text{C}$	1.5	1.8	V
			$T_J = 175\text{ }^\circ\text{C}$	1.9		
Q_C	Total capacitive charge	$V_R = 400\text{ V}$		133		nC
C	Total capacitance	$f = 1\text{ MHz}, V_R = 200\text{ V}$		248		pF
		$f = 1\text{ MHz}, V_R = 400\text{ V}$		216		
R_{thJC}	Junction-to-case thermal resistance				0.86	$^\circ\text{C/W}$

3.3 Diode Characteristics

This section shows the electrical characteristics and ratings of the CR1 diode.

Table 7 • Absolute Maximum Ratings

Symbol	Parameter		Max Ratings	Unit	
V_{RRM}	Peak repetitive reverse voltage		1600	V	
I_F	DC forward current	$T_C = 80\text{ }^\circ\text{C}$	200	A	
I_{FSM}	Non-repetitive forward surge current	$t = 10\text{ ms}$ $T_J = 25\text{ }^\circ\text{C}$	1600		
P_D	Power dissipation		$T_C = 25\text{ }^\circ\text{C}$	400	W

Table 8 • Electrical Characteristics

Symbol	Characteristic	Test Conditions		Min	Typ	Max	Unit
I_R	Reverse current	$V_R = 1600\text{ V}$				50	μA
V_F	Forward voltage	$I_F = 77\text{ A}$	$T_J = 25\text{ }^\circ\text{C}$		1	1.21	V
			$T_J = 125\text{ }^\circ\text{C}$		0.9	1.1	
V_T	On-state voltage					0.83	V
r_T	On-state slope resistance					2.2	$\text{m}\Omega$
R_{thJC}	Junction-to-case thermal resistance					0.31	$^\circ\text{C}/\text{W}$

3.4 Thyristor Characteristics

This section shows the electrical characteristics and ratings of the thyristor (Q3).

Table 9 • Absolute Maximum Ratings

Symbol	Parameter		Max Ratings	Unit	
V_{DRM}	Repetitive peak reverse voltage		1600	V	
I_{DRM}	Repetitive peak reverse current		3	mA	
I_{TRMS}	RMS on-state current	$T_C = 90\text{ }^\circ\text{C}$	60	A	
I_{TSM}	Surge on-state current	$t = 10\text{ ms}$ $T_J = 45\text{ }^\circ\text{C}$	520		
V_{RGM}	Peak reverse gate voltage		10	V	
P_D	Power dissipation		$T_C = 25\text{ }^\circ\text{C}$	357	W

Table 10 • Electrical Characteristics

Symbol	Characteristic	Test Conditions		Min	Typ	Max	Unit
V_T	On-state Voltage	$I_T = 60 \text{ A}$	$T_J = 25 \text{ }^\circ\text{C}$		1.41		V
V_{TO}	Direct on state threshold voltage		$T_J = 125 \text{ }^\circ\text{C}$		0.85		
r_T	On-state Slope resistance		$T_J = 125 \text{ }^\circ\text{C}$		10		m Ω
V_{GT}	Gate trigger voltage		$T_J = 25 \text{ }^\circ\text{C}$		1.5		V
I_{GT}	Gate trigger current				50		mA
R_{thJC}	Junction-to-case thermal resistance					0.35	$^\circ\text{C}/\text{W}$

3.5 Thermal and Package Characteristics

This section shows the thermal and package characteristics of the device.

Table 11 • Package Characteristics

Symbol	Characteristic		Min	Max	Unit	
V_{ISOL}	RMS Isolation Voltage, any terminal to case $t = 1 \text{ min}$, 50/60 Hz		4000		V	
T_J	Operating junction temperature range	Q3, CR1	-40	150	$^\circ\text{C}$	
		Q1, Q2, CR2, CR3	-40	175		
T_{JOP}	Recommended junction temperature under switching conditions		-40	$T_{Jmax} - 25$		
T_{STG}	Storage temperature range		-40	125		
T_C	Operating case temperature		-40	125		
Torque	Mounting torque	To Heatsink	M4	2	3	N.m
Weight	Package weight				110	g

3.6 Typical SiC MOSFET Performance Curve

This section shows the typical performance curves of the MSCSM70VM19C3AG SiC MOSFET.

Figure 3 • Maximum Thermal Impedance

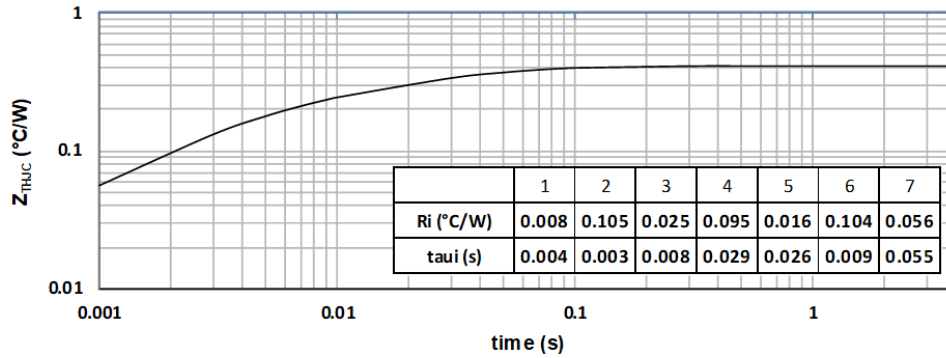

Figure 4 • Output Characteristics at T_J = 25 °C

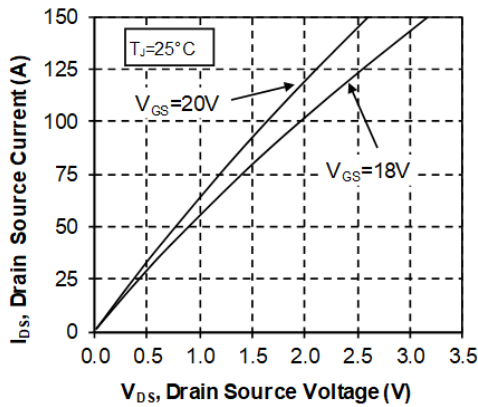

Figure 5 • Output Characteristics at T_J = 175 °C

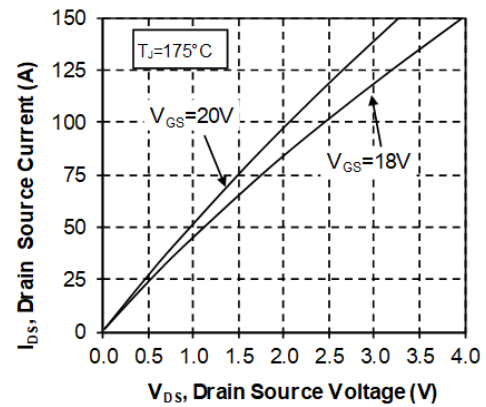

Figure 6 • Normalized RDS(on) vs. Temperature

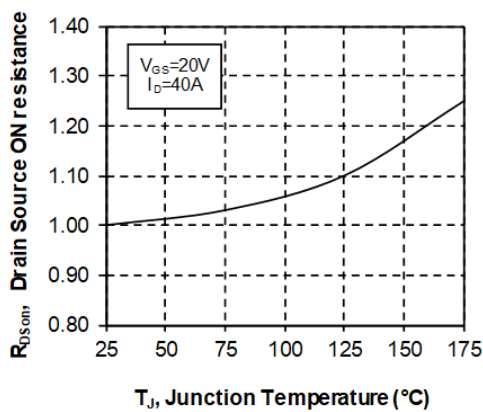

Figure 7 • Transfer Characteristics

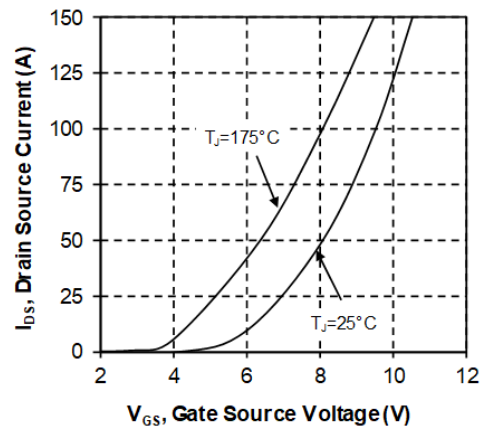

Figure 8 • Capacitance vs. Drain Source Voltage

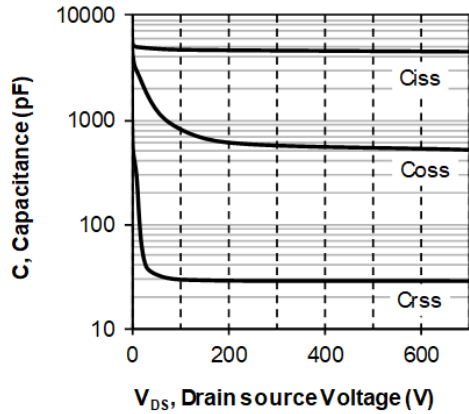

Figure 9 • Gate Charge vs. Gate Source Voltage

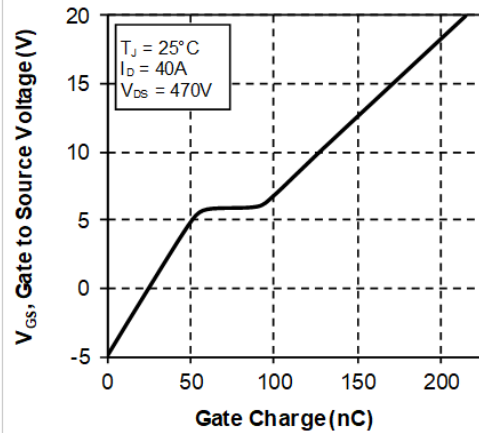

Figure 10 • Body Diode Char, T_J = 25 °C

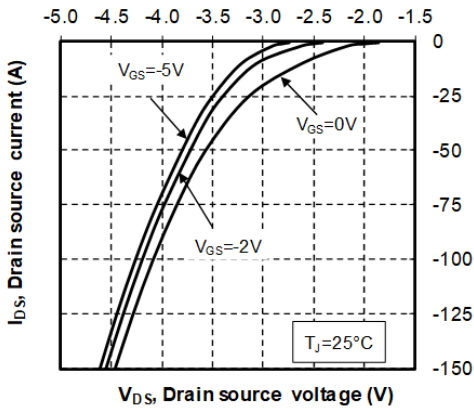

Figure 11 • 3rd Quadrant Char, T_J = 25 °C

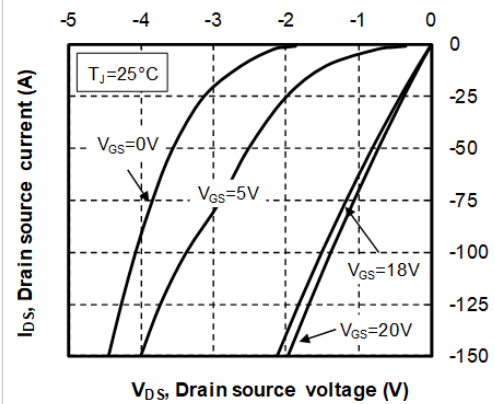

Figure 12 • Body Diode Char, T_J = 175 °C

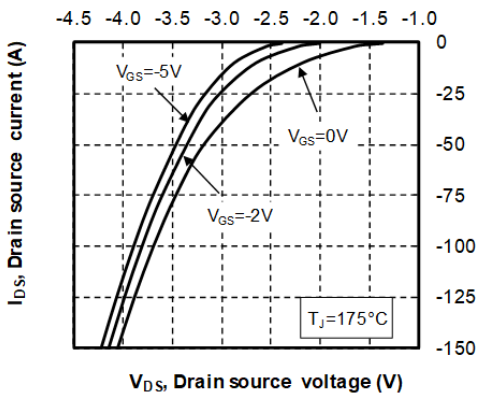

Figure 13 • 3rd Quadrant Char, T_J = 175 °C

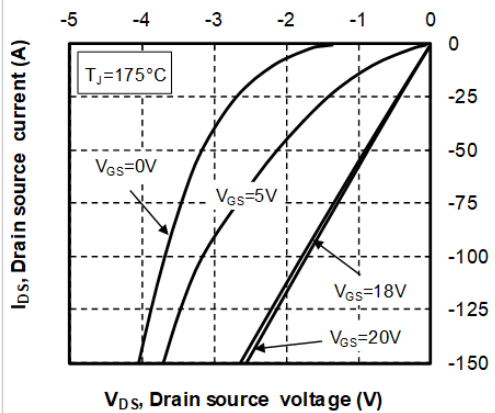

Figure 14 • Switching Energy vs. Current

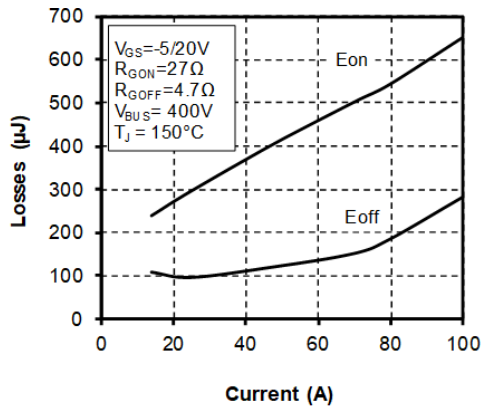

Figure 15 • Turn-on Energy vs. Rg

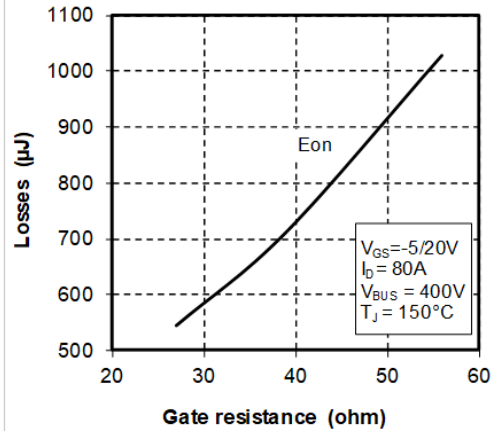

Figure 16 • Operating Frequency vs. Drain Current

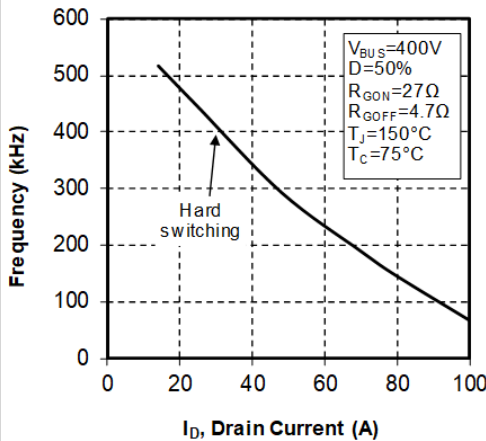
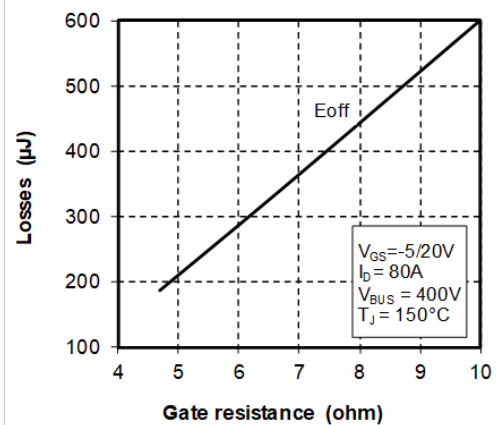

Figure 17 • Turn-off Energy vs. Rg



3.7 Typical SiC Diode Performance

This section shows the typical performance curves of the MSCSM70VM19C3AG SiC diodes (CR2 and CR3).

Figure 18 • Maximum Thermal Impedance

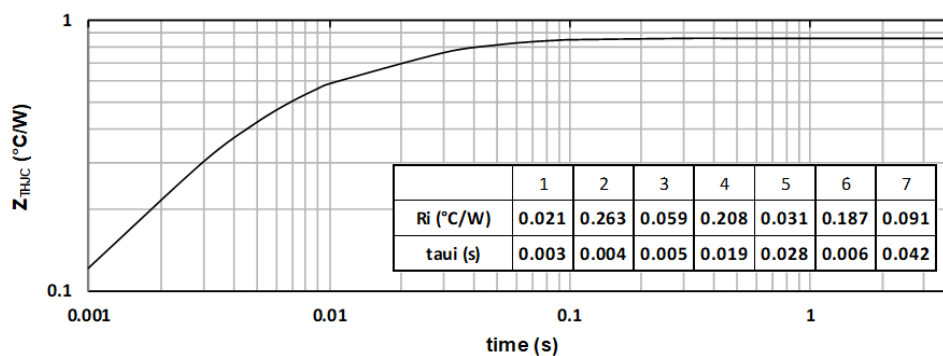

Figure 19 • Forward Characteristics

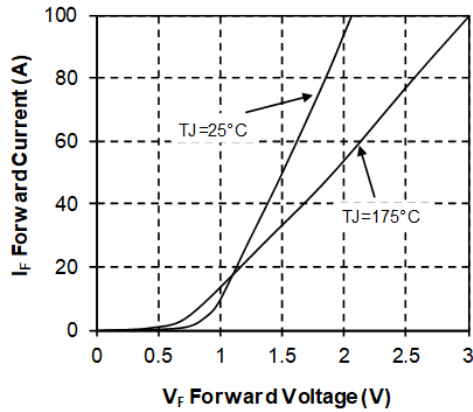
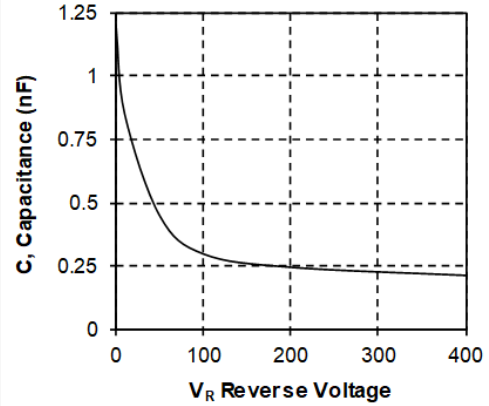

Figure 20 • Capacitance vs. Reverse Voltage



3.8 Typical Diode Curves

This section shows the typical performance curves of the MSCSM70VM19C3AG CR1 diode.

Figure 21 • Maximum Thermal Impedance

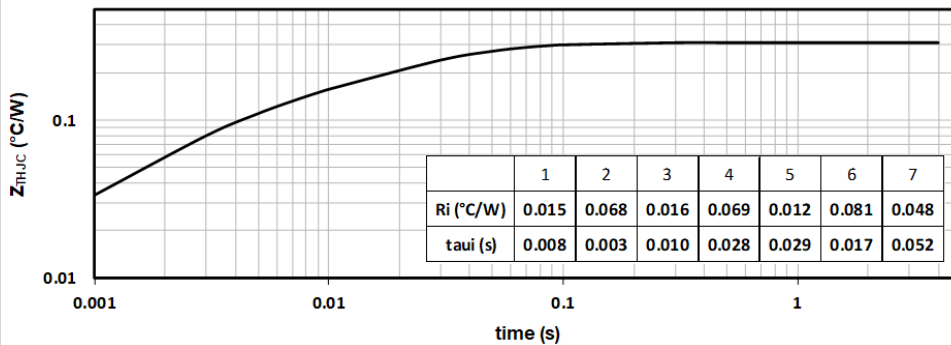
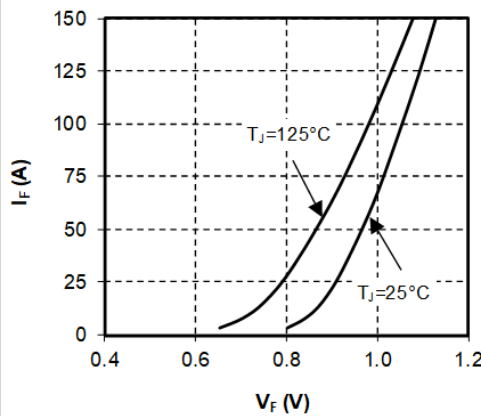

Figure 22 • Forward Characteristics



4 Package Specification

This section shows the package outline of the MSCSM70VM19C3AG device. All dimensions are in millimeters.

Figure 23 • Package Outline

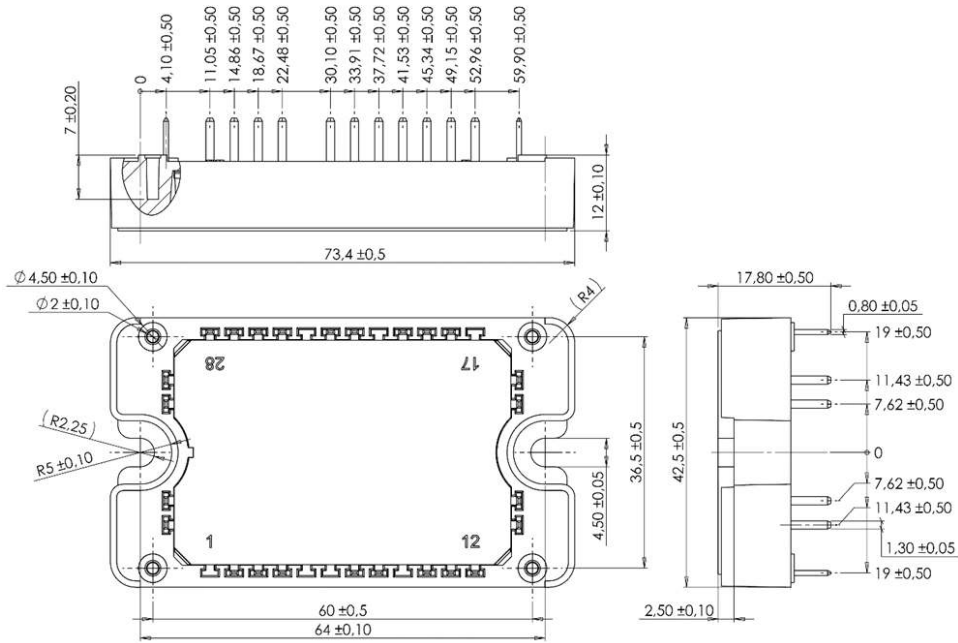

See application note 1906 - Mounting Instructions for SP3F Power Modules on www.microsemi.com

**Microsemi**

2355 W. Chandler Blvd.
 Chandler, AZ 85224 USA

Within the USA: +1 (480) 792-7200
 Fax: +1 (480) 792-7277

www.microsemi.com © 2020 Microsemi and its corporate affiliates. All rights reserved. Microsemi and the Microsemi logo are trademarks of Microsemi Corporation and its corporate affiliates. All other trademarks and service marks are the property of their respective owners.

Microsemi's product warranty is set forth in Microsemi's Sales Order Terms and Conditions. Information contained in this publication is provided for the sole purpose of designing with and using Microsemi products. Information regarding device applications and the like is provided only for your convenience and may be superseded by updates. Buyer shall not rely on any data and performance specifications or parameters provided by Microsemi. It is your responsibility to ensure that your application meets with your specifications. THIS INFORMATION IS PROVIDED "AS IS." MICROSEMI MAKES NO REPRESENTATIONS OR WARRANTIES OF ANY KIND WHETHER EXPRESS OR IMPLIED, WRITTEN OR ORAL, STATUTORY OR OTHERWISE, RELATED TO THE INFORMATION, INCLUDING BUT NOT LIMITED TO ITS CONDITION, QUALITY, PERFORMANCE, NON-INFRINGEMENT, MERCHANTABILITY OR FITNESS FOR A PARTICULAR PURPOSE. IN NO EVENT WILL MICROSEMI BE LIABLE FOR ANY INDIRECT, SPECIAL, PUNITIVE, INCIDENTAL OR CONSEQUENTIAL LOSS, DAMAGE, COST OR EXPENSE WHATSOEVER RELATED TO THIS INFORMATION OR ITS USE, HOWEVER CAUSED, EVEN IF MICROSEMI HAS BEEN ADVISED OF THE POSSIBILITY OR THE DAMAGES ARE FORESEEABLE. TO THE FULLEST EXTENT ALLOWED BY LAW, MICROSEMI'S TOTAL LIABILITY ON ALL CLAIMS IN RELATED TO THIS INFORMATION OR ITS USE WILL NOT EXCEED THE AMOUNT OF FEES, IF ANY, YOU PAID DIRECTLY TO MICROSEMI FOR THIS INFORMATION. Use of Microsemi devices in life support, mission-critical equipment or applications, and/or safety applications is entirely at the buyer's risk, and the buyer agrees to defend and indemnify Microsemi from any and all damages, claims, suits, or expenses resulting from such use. No licenses are conveyed, implicitly or otherwise, under any Microsemi intellectual property rights unless otherwise stated.

Microsemi Corporation, a subsidiary of Microchip Technology Inc. (Nasdaq: MCHP), and its corporate affiliates are leading providers of smart, connected and secure embedded control solutions. Their easy-to-use development tools and comprehensive product portfolio enable customers to create optimal designs which reduce risk while lowering total system cost and time to market. These solutions serve more than 120,000 customers across the industrial, automotive, consumer, aerospace and defense, communications and computing markets. Headquartered in Chandler, Arizona, the company offers outstanding technical support along with dependable delivery and quality. Learn more at www.microsemi.com.

MSCC-0344-DS-01076