

1

2

3

4

5

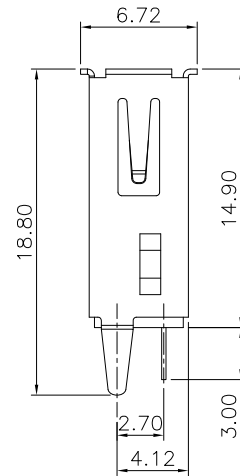
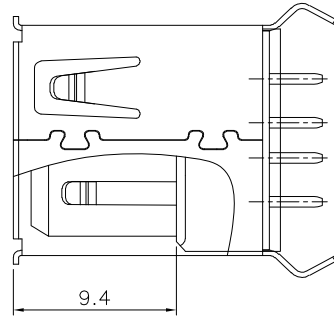
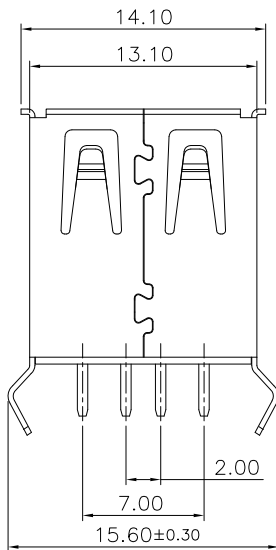
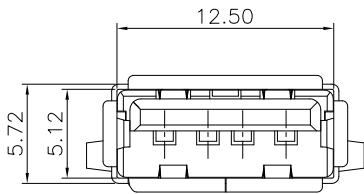

Specifications:

Current Rating:1.0A AC/DC
Voltage Rating:30V AC/DC
Contact Resistance:30m ohm. Max.
Insulation Resistance:1,000M ohm. min.
Withstanding Voltage:500V AC For One Minute
Operating Temperature Range:-40°C ~ +105°C

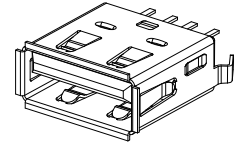

Material And Finish

Insulator:PBT (UL94V-0)
Contact:Phosphor Bronze
Plating:Gold Plated on Contact Area,
Tin Plated on Solder Tail.
Shell:Brass, Nickel Plated

How To Order

USB-A1VSXX

- 6:Gold Plated on Contact Area
- 7:Selective Gold Plated 15u"
- 8:Selective Gold Plated 30u"
- B: Black
- W: White

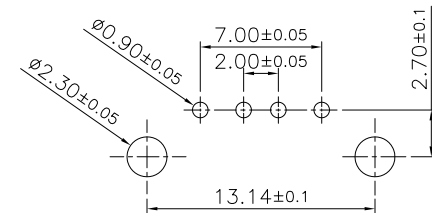

P.C.B Layout

RoHS Compliant

F				DRAWN:	GENERAL TOLERANCE:	 ON-SHORE TECHNOLOGY, INC.	DESCRIPTION: USB A Type PCB Socket Top Entry	SIZE
E			Jack Huang	.X=±0.20 .XX=±0.10				
D			CHECKED:	UNIT: MM				
C			Jerry Chen	SCALE: 1:1				
B	15-SEP-2021	Change Tray icon	Lisy Liu	APPROVAL:	SHEET: 1/2			
A	15-NOV-2018		Jack Huang	Mike Wu	PROJECTION:	USB-A1VSXX		
REV	DATE	FILE	BY					